

# BGU7005

SiGe:C Low Noise Amplifier MMIC for GPS

Rev. 02 — 4 March 2010

Product data sheet

## 1. Product profile

### 1.1 General description

The BGU7005 is a Low Noise Amplifier (LNA) for GPS receiver applications in a plastic leadless 6-pin, extremely small SOT886 package. The BGU7005 requires only one external matching inductor and one external decoupling capacitor.

The BGU7005 adapts itself to the changing environment resulting from co-habitation of different radio systems in modern cellular handsets. It has been designed for low power consumption and optimal performance when jamming signals from co-existing cellular transmitters are present. At low jamming power levels it delivers 16.5 dB gain at a noise figure of 0.9 dB. During high jamming power levels, resulting for example from a cellular transmit burst, it temporarily increases its bias current to improve sensitivity.

#### CAUTION



This device is sensitive to ElectroStatic Discharge (ESD). Therefore care should be taken during transport and handling.

### 1.2 Features and benefits

- Small 6-pin leadless package 1 mm × 1.45 mm × 0.5 mm
- Low noise high gain MMIC
- Integrated temperature stabilized bias for easy design
- Requires only one input matching inductor and one supply decoupling capacitor
- Input and output DC decoupled
- Noise figure (NF) = 0.9 dB at 1.575 GHz
- Integrated matching for the output
- Gain 16.5 dB at 1.575 GHz
- High 1 dB compression point of -11 dBm
- High out of band IP<sub>3</sub> of 9 dBm
- 110 GHz transit frequency - SiGe:C technology
- Supply voltage 1.5 V to 2.85 V, optimized for 1.8 V
- Power-down mode current consumption < 1 μA
- Optimized performance at low 4.5 mA supply current
- ESD protection on all pins (HBM > 1 kV)

### 1.3 Applications

- LNA for GPS in handsets, PDA's and Portable Navigation Devices



### 1.4 Quick reference data

**Table 1. Quick reference data**

$f = 1575 \text{ MHz}$ ;  $V_{CC} = 1.8 \text{ V}$ ;  $P_i < -40 \text{ dBm}$ ;  $T_{amb} = 25 \text{ }^\circ\text{C}$ ; input matched to  $50 \text{ }\Omega$  using a  $5.6 \text{ nH}$  inductor; unless otherwise specified.

Symbol	Parameter	Conditions	Min	Typ	Max	Unit	
$V_{CC}$	supply voltage	RF input AC coupled	1.5	-	2.85	V	
$I_{CC}$	supply current	$V_{ENABLE} \geq 0.8 \text{ V}$					
		$P_i < -40 \text{ dBm}$	-	4.5	-	mA	
		$P_i = -20 \text{ dBm}$	-	12	-	mA	
$G_p$	power gain	$P_i < -40 \text{ dBm}$	14	16.5	19	dB	
		$P_i = -20 \text{ dBm}$	15	17.5	20	dB	
NF	noise figure	$P_i < -40 \text{ dBm}$	-	0.9	1.3	dB	
		$P_i = -20 \text{ dBm}$	-	1.2	1.6	dB	
$P_{i(1dB)}$	input power at 1 dB gain compression	$f = 1.575 \text{ GHz}$					
		$V_{CC} = 1.5 \text{ V}$	-15	-12	-	dBm	
		$V_{CC} = 1.8 \text{ V}$	-14	-11	-	dBm	
		$V_{CC} = 2.85 \text{ V}$	-11	-8	-	dBm	
IP <sub>3i</sub>	input third-order intercept point	$f = 1.575 \text{ GHz}$					
		$V_{CC} = 1.5 \text{ V}$	[1]	5	8	-	dBm
		$V_{CC} = 1.8 \text{ V}$	[1]	5	9	-	dBm
		$V_{CC} = 2.85 \text{ V}$	[1]	5	12	-	dBm

[1]  $f_1 = 1713 \text{ MHz}$ ;  $f_2 = 1851 \text{ MHz}$ .

## 2. Pinning information

**Table 2. Pinning**

Pin	Description	Simplified outline	Graphic symbol
1	GND	<p>bottom view</p>	<p>sym129</p>
2	GND		
3	RF_IN		
4	$V_{CC}$		
5	ENABLE		
6	RF_OUT		

## 3. Ordering information

**Table 3. Ordering information**

Type number	Package		Version
	Name	Description	
BGU7005	XSON6	plastic extremely thin small outline package; no leads; 6 terminals; body 1 x 1.45 x 0.5 mm	SOT886

## 4. Marking

Table 4. Marking codes

Type number	Marking code
BGU7005	AC

## 5. Limiting values

Table 5. Limiting values

In accordance with the Absolute Maximum Rating System (IEC 60134).

Symbol	Parameter	Conditions	Min	Max	Unit
$V_{CC}$	supply voltage	RF input AC coupled	-0.2	+3.1	V
$P_{tot}$	total power dissipation	$T_{sp} \leq 130\text{ °C}$	[1]	55	mW
$T_{stg}$	storage temperature		-65	150	°C
$T_j$	junction temperature		-	150	°C

[1]  $T_{sp}$  is the temperature at the soldering point of the emitter lead.

## 6. Thermal characteristics

Table 6. Thermal characteristics

Symbol	Parameter	Conditions	Typ	Unit
$R_{th(j-sp)}$	thermal resistance from junction to solder point		225	K/W

## 7. Characteristics

Table 7. Characteristics

$f = 1575\text{ MHz}$ ;  $V_{CC} = 1.8\text{ V}$ ;  $V_{ENABLE} \geq 0.8\text{ V}$ ;  $P_i < -40\text{ dBm}$ ;  $T_{amb} = 25\text{ °C}$ ; input matched to  $50\ \Omega$  using a  $5.6\text{ nH}$  inductor; unless otherwise specified.

Symbol	Parameter	Conditions	Min	Typ	Max	Unit
$V_{CC}$	supply voltage	RF input AC coupled	1.5	-	2.85	V
$I_{CC}$	supply current	$V_{ENABLE} \geq 0.8\text{ V}$				
		$P_i < -40\text{ dBm}$	-	4.5	-	mA
		$P_i = -20\text{ dBm}$	-	12	-	mA
		$V_{ENABLE} \leq 0.35\text{ V}$	-	-	0.001	mA
$T_{amb}$	ambient temperature		-40	+25	+85	°C

**Table 7. Characteristics ...continued**

$f = 1575 \text{ MHz}$ ;  $V_{CC} = 1.8 \text{ V}$ ;  $V_{ENABLE} \geq 0.8 \text{ V}$ ;  $P_i < -40 \text{ dBm}$ ;  $T_{amb} = 25 \text{ }^\circ\text{C}$ ; input matched to  $50 \text{ } \Omega$  using a  $5.6 \text{ nH}$  inductor; unless otherwise specified.

Symbol	Parameter	Conditions	Min	Typ	Max	Unit		
$G_p$	power gain	$T_{amb} = 25 \text{ }^\circ\text{C}$						
		no jammer	14	16.5	19	dB		
		$P_i = -20 \text{ dBm}$ ; $f_i = 1575 \text{ MHz}$	15	17.5	20	dB		
		$P_{jam} = -20 \text{ dBm}$ ; $f_{jam} = 850 \text{ MHz}$	15	17.5	20	dB		
		$P_{jam} = -20 \text{ dBm}$ ; $f_{jam} = 1850 \text{ MHz}$	15	17.5	20	dB		
		$-40 \text{ }^\circ\text{C} \leq T_{amb} \leq +85 \text{ }^\circ\text{C}$						
		no jammer	13	-	20	dB		
		$P_i = -20 \text{ dBm}$ ; $f_i = 1575 \text{ MHz}$	14	-	21	dB		
		$P_{jam} = -20 \text{ dBm}$ ; $f_{jam} = 850 \text{ MHz}$	14	-	21	dB		
		$P_{jam} = -20 \text{ dBm}$ ; $f_{jam} = 1850 \text{ MHz}$	14	-	21	dB		
		$RL_{in}$	input return loss	$P_i < -40 \text{ dBm}$	5	8	-	dB
				$P_i = -20 \text{ dBm}$	6	10	-	dB
$RL_{out}$	output return loss	$P_i < -40 \text{ dBm}$	10	20	-	dB		
		$P_i = -20 \text{ dBm}$	10	14	-	dB		
ISL	isolation		20	23	-	dB		
NF	noise figure	$T_{amb} = 25 \text{ }^\circ\text{C}$						
		no jammer	-	0.9	1.3	dB		
		$P_i = -20 \text{ dBm}$ ; $f_i = 1575 \text{ MHz}$	-	1.2	1.6	dB		
		$P_{jam} = -20 \text{ dBm}$ ; $f_{jam} = 850 \text{ MHz}$	-	1.1	1.5	dB		
		$P_{jam} = -20 \text{ dBm}$ ; $f_{jam} = 1850 \text{ MHz}$	-	1.3	1.7	dB		
		$-40 \text{ }^\circ\text{C} \leq T_{amb} \leq +85 \text{ }^\circ\text{C}$						
		no jammer	-	-	1.7	dB		
		$P_i = -20 \text{ dBm}$ ; $f_i = 1575 \text{ MHz}$	-	-	1.9	dB		
		$P_{jam} = -20 \text{ dBm}$ ; $f_{jam} = 850 \text{ MHz}$	-	-	1.8	dB		
		$P_{jam} = -20 \text{ dBm}$ ; $f_{jam} = 1850 \text{ MHz}$	-	-	2.0	dB		
		$P_{i(1dB)}$	input power at 1 dB gain compression	$f = 1575 \text{ MHz}$				
				$V_{CC} = 1.5 \text{ V}$	-15	-12	-	dBm
$V_{CC} = 1.8 \text{ V}$	-14			-11	-	dBm		
$V_{CC} = 2.85 \text{ V}$	-11			-8	-	dBm		
$f = 806 \text{ MHz to } 928 \text{ MHz}$								
$V_{CC} = 1.5 \text{ V}$	[1]			-15	-12	-	dBm	
$V_{CC} = 1.8 \text{ V}$	[1]			-14	-11	-	dBm	
$V_{CC} = 2.85 \text{ V}$	[1]			-14	-11	-	dBm	
$f = 1612 \text{ MHz to } 1909 \text{ MHz}$								
$V_{CC} = 1.5 \text{ V}$	[1]			-13	-10	-	dBm	
$V_{CC} = 1.8 \text{ V}$	[1]			-12	-9	-	dBm	
$V_{CC} = 2.85 \text{ V}$	[1]			-10	-7	-	dBm	

**Table 7. Characteristics ...continued**

$f = 1575 \text{ MHz}$ ;  $V_{CC} = 1.8 \text{ V}$ ;  $V_{ENABLE} \geq 0.8 \text{ V}$ ;  $P_i < -40 \text{ dBm}$ ;  $T_{amb} = 25 \text{ }^\circ\text{C}$ ; input matched to  $50 \text{ } \Omega$  using a  $5.6 \text{ nH}$  inductor; unless otherwise specified.

Symbol	Parameter	Conditions	Min	Typ	Max	Unit	
IP <sub>3i</sub>	input third-order intercept point	$f = 1.575 \text{ GHz}$					
		$V_{CC} = 1.5 \text{ V}$	[2]	5	8	-	dBm
		$V_{CC} = 1.8 \text{ V}$	[2]	5	9	-	dBm
		$V_{CC} = 2.85 \text{ V}$	[2]	5	12	-	dBm
t <sub>on</sub>	turn-on time		[3]	-	-	2	$\mu\text{s}$
t <sub>off</sub>	turn-off time		[3]	-	-	1	$\mu\text{s}$
K	Rollett stability factor		1	-	-		

[1] Out of band.

[2]  $f_1 = 1713 \text{ MHz}$ ;  $f_2 = 1851 \text{ MHz}$ .

[3] Within 10 % of the final gain.

**Table 8. ENABLE (pin 5)**

$-40 \text{ }^\circ\text{C} \leq T_{amb} \leq +85 \text{ }^\circ\text{C}$ ;  $1.5 \text{ V} \leq V_{CC} \leq 2.85 \text{ V}$

V <sub>ENABLE</sub> (V)	State
$\leq 0.35$	OFF
$\geq 0.8$	ON

## 8. Application information

### 8.1 GPS LNA

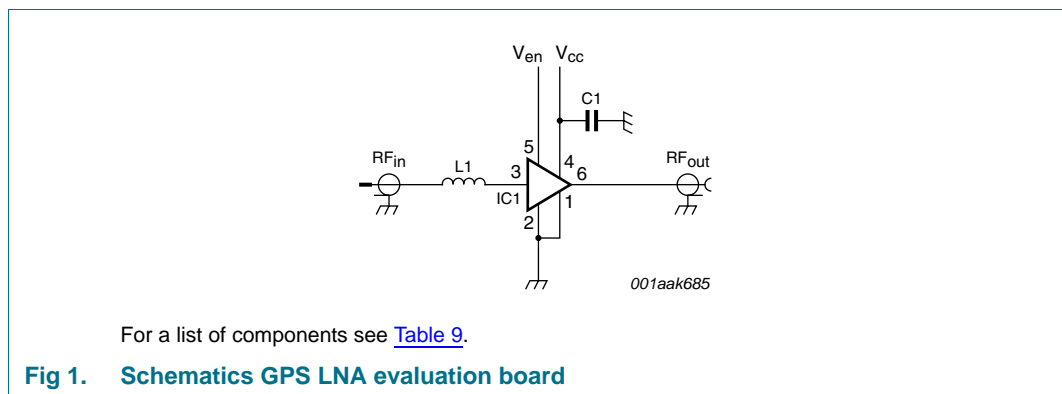

**Table 9. List of components**

For schematics see [Figure 1](#).

Component	Description	Value	Supplier	Remarks
C1	decoupling capacitor	1 nF	various	
IC1	BGU7005	-	NXP	
L1	high quality matching inductor	5.6 nH	Murata LQW15A	

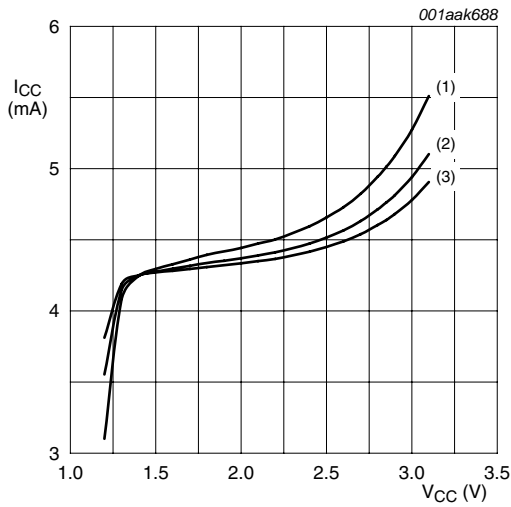

$P_i = -45$  dBm.  
 (1)  $T_{amb} = -40$  °C  
 (2)  $T_{amb} = +25$  °C  
 (3)  $T_{amb} = +85$  °C

**Fig 2. Supply current as a function of supply voltage; typical values**

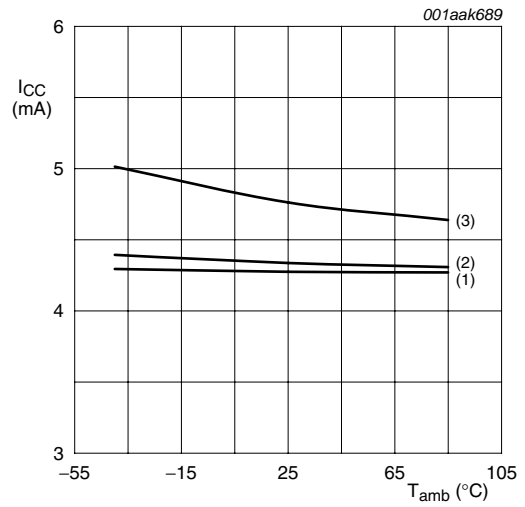

$P_i = -45$  dBm.  
 (1)  $V_{CC} = 1.5$  V  
 (2)  $V_{CC} = 1.8$  V  
 (3)  $V_{CC} = 2.85$  V

**Fig 3. Supply current as a function of ambient temperature; typical values**

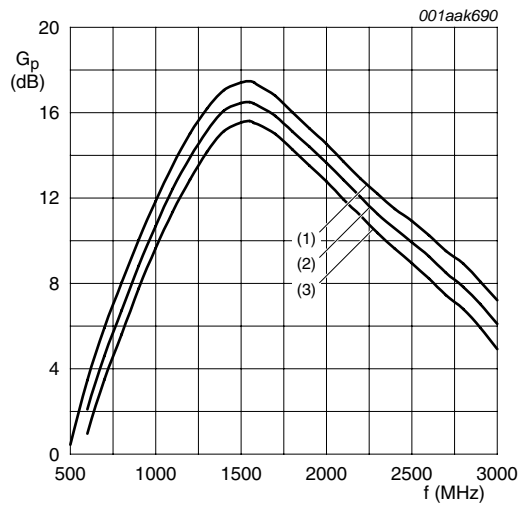

$V_{CC} = 1.8$  V;  $P_i = -45$  dBm.  
 (1)  $T_{amb} = -40$  °C  
 (2)  $T_{amb} = +25$  °C  
 (3)  $T_{amb} = +85$  °C

**Fig 4. Power gain as a function of frequency; typical values**

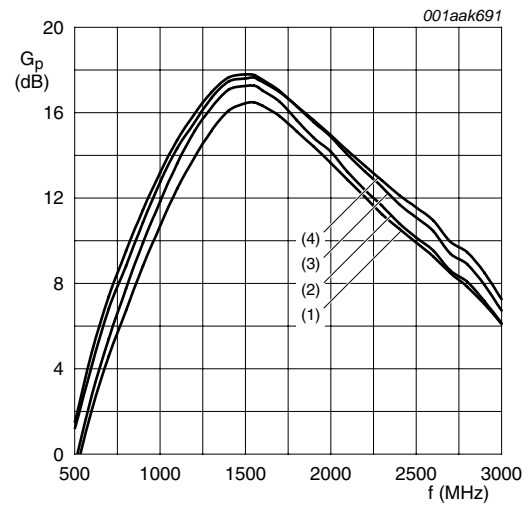

$V_{CC} = 1.8$  V;  $T_{amb} = 25$  °C.  
 (1)  $P_i = -45$  dBm  
 (2)  $P_i = -30$  dBm  
 (3)  $P_i = -20$  dBm  
 (4)  $P_i = -15$  dBm

**Fig 5. Power gain as a function of frequency; typical values**

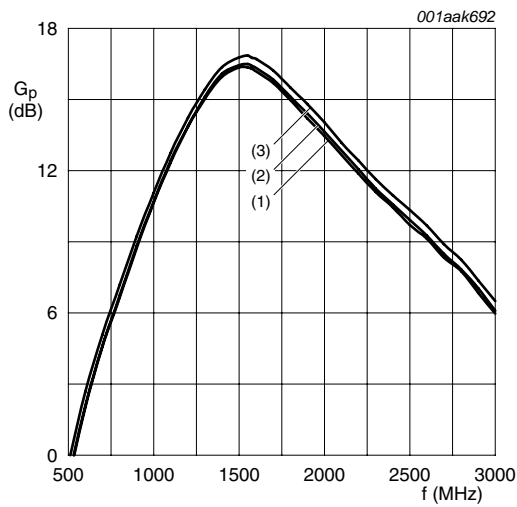

$P_i = -45$  dBm;  $T_{amb} = 25$  °C.  
 (1)  $V_{CC} = 1.5$  V  
 (2)  $V_{CC} = 1.8$  V  
 (3)  $V_{CC} = 2.85$  V

**Fig 6. Power gain as a function of frequency; typical values**

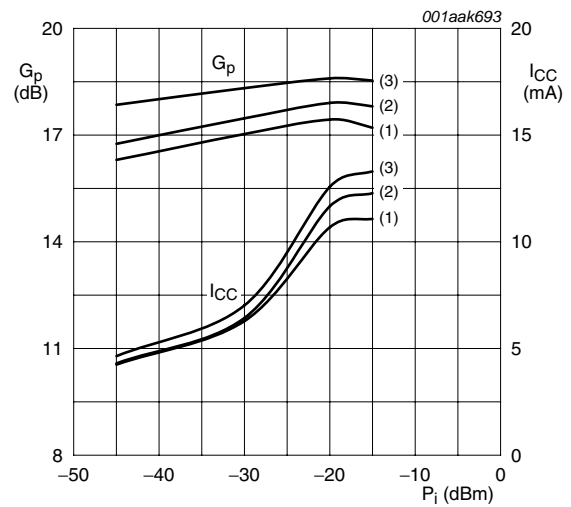

$T_{amb} = 25$  °C;  $f = 1575$  MHz.  
 (1)  $V_{CC} = 1.5$  V  
 (2)  $V_{CC} = 1.8$  V  
 (3)  $V_{CC} = 2.85$  V

**Fig 7. Power gain as a function of input power; typical values**

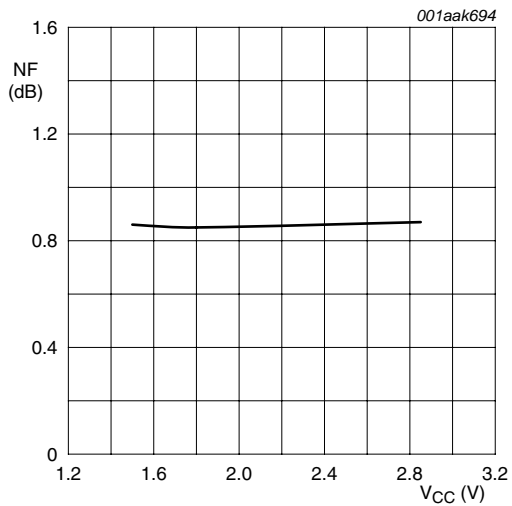

$f = 1575$  MHz;  $T_{amb} = 25$  °C; no jammer.

**Fig 8. Noise figure as a function of supply current; typical values**

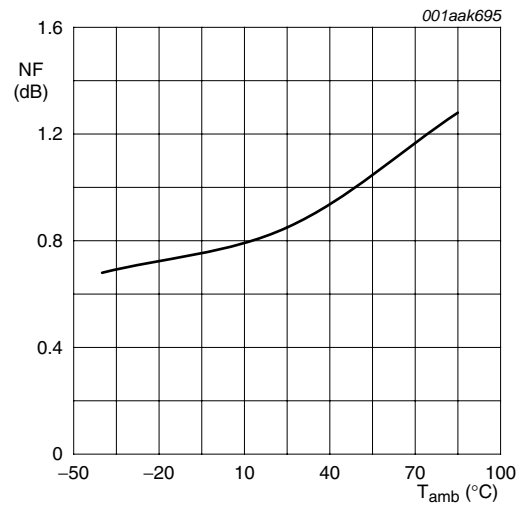

$f = 1575$  MHz;  $V_{CC} = 1.8$  V; no jammer.

**Fig 9. Noise figure as a function of ambient temperature; typical values**

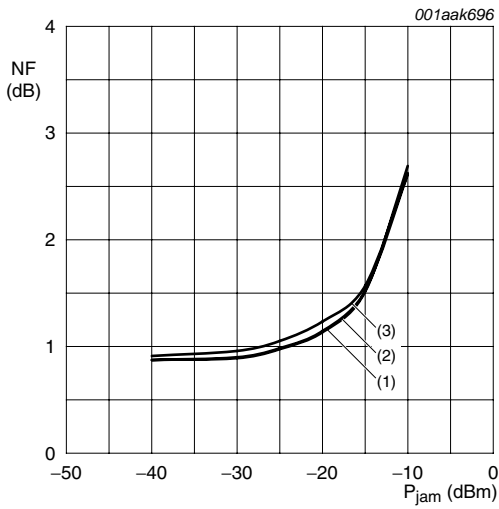

$f_{jam} = 850 \text{ MHz}; T_{amb} = 25 \text{ }^\circ\text{C}; f = 1575 \text{ MHz}.$   
 (1)  $V_{CC} = 1.5 \text{ V}$   
 (2)  $V_{CC} = 1.8 \text{ V}$   
 (3)  $V_{CC} = 2.85 \text{ V}$

**Fig 10. Noise figure as a function of jamming power; typical values**

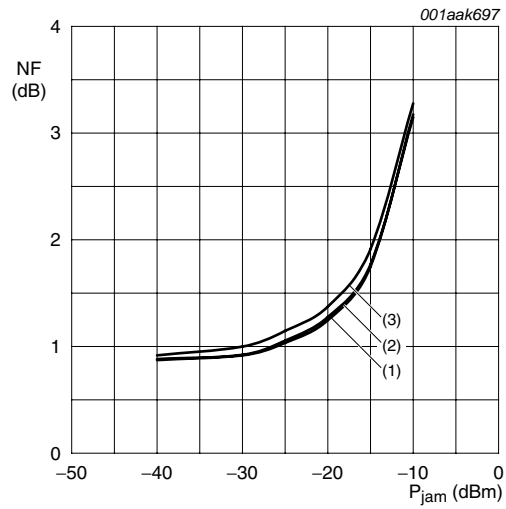

$f_{jam} = 1850 \text{ MHz}; T_{amb} = 25 \text{ }^\circ\text{C}; f = 1575 \text{ MHz}.$   
 (1)  $V_{CC} = 1.5 \text{ V}$   
 (2)  $V_{CC} = 1.8 \text{ V}$   
 (3)  $V_{CC} = 2.85 \text{ V}$

**Fig 11. Noise figure as a function of jamming power; typical values**

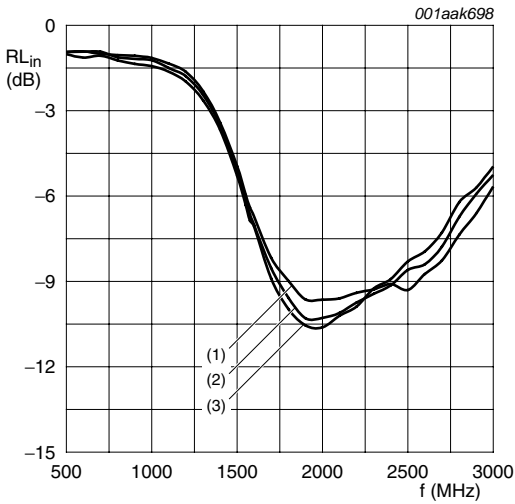

$V_{CC} = 1.8 \text{ V}; P_i = -45 \text{ dBm}.$   
 (1)  $T_{amb} = -40 \text{ }^\circ\text{C}$   
 (2)  $T_{amb} = +25 \text{ }^\circ\text{C}$   
 (3)  $T_{amb} = +85 \text{ }^\circ\text{C}$

**Fig 12. Input return loss as a function of frequency; typical values**

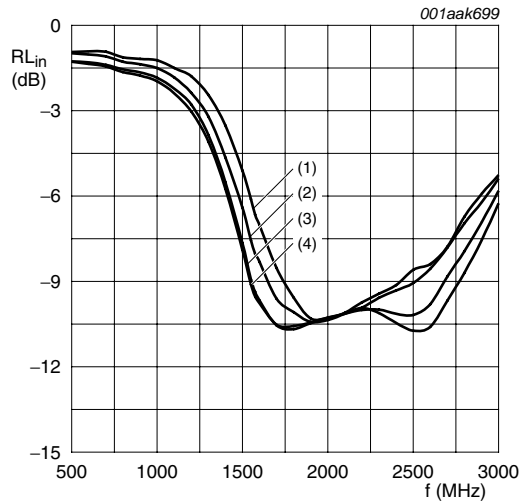

$V_{CC} = 1.8 \text{ V}; T_{amb} = 25 \text{ }^\circ\text{C}.$   
 (1)  $P_i = -45 \text{ dBm}$   
 (2)  $P_i = -30 \text{ dBm}$   
 (3)  $P_i = -20 \text{ dBm}$   
 (4)  $P_i = -15 \text{ dBm}$

**Fig 13. Input return loss as a function of frequency; typical values**



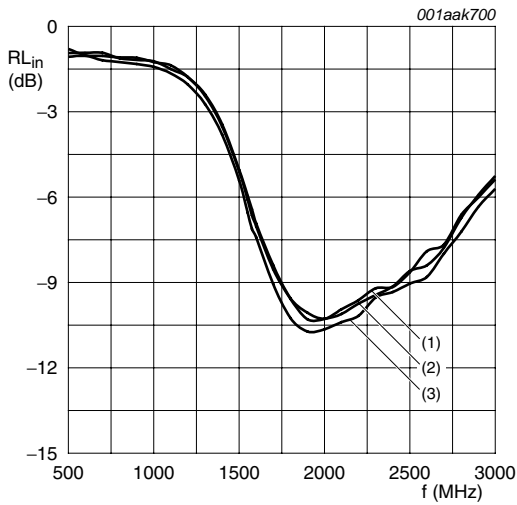

$P_i = -45 \text{ dBm}; T_{\text{amb}} = 25 \text{ }^\circ\text{C}.$   
 (1)  $V_{CC} = 1.5 \text{ V}$   
 (2)  $V_{CC} = 1.8 \text{ V}$   
 (3)  $V_{CC} = 2.85 \text{ V}$

**Fig 14. Input return loss as a function of frequency; typical values**

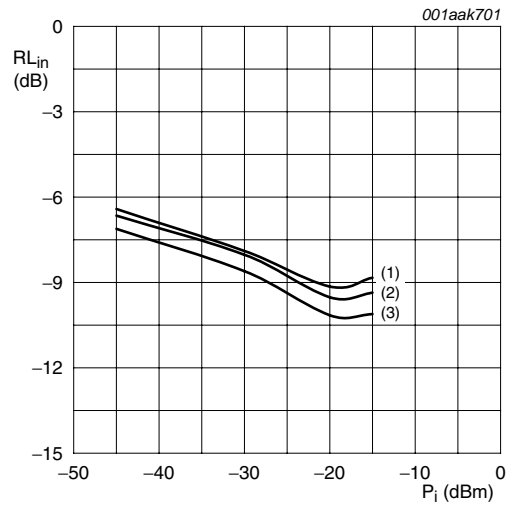

$T_{\text{amb}} = 25 \text{ }^\circ\text{C}; f = 1575 \text{ MHz}.$   
 (1)  $V_{CC} = 1.5 \text{ V}$   
 (2)  $V_{CC} = 1.8 \text{ V}$   
 (3)  $V_{CC} = 2.85 \text{ V}$

**Fig 15. Input return loss as a function of input power; typical values**

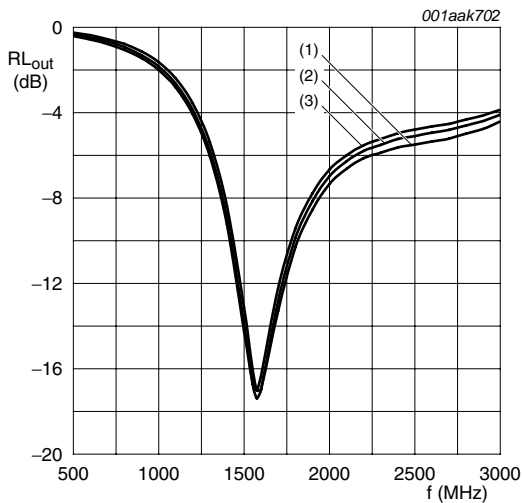

$V_{CC} = 1.8 \text{ V}; P_i = -45 \text{ dBm}.$   
 (1)  $T_{\text{amb}} = -40 \text{ }^\circ\text{C}$   
 (2)  $T_{\text{amb}} = +25 \text{ }^\circ\text{C}$   
 (3)  $T_{\text{amb}} = +85 \text{ }^\circ\text{C}$

**Fig 16. Output return loss as a function of frequency; typical values**

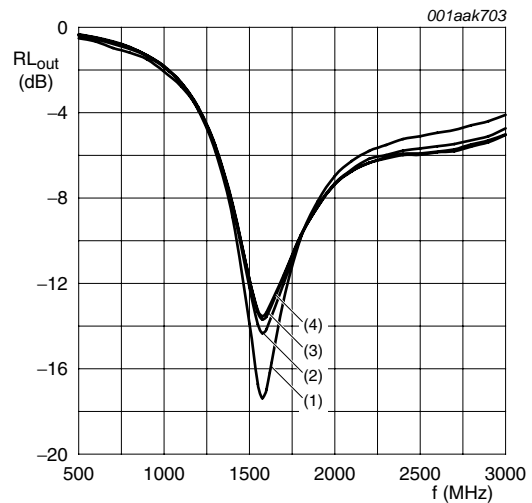

$V_{CC} = 1.8 \text{ V}; T_{\text{amb}} = 25 \text{ }^\circ\text{C}.$   
 (1)  $P_i = -45 \text{ dBm}$   
 (2)  $P_i = -30 \text{ dBm}$   
 (3)  $P_i = -20 \text{ dBm}$   
 (4)  $P_i = -15 \text{ dBm}$

**Fig 17. Output return loss as a function of frequency; typical values**

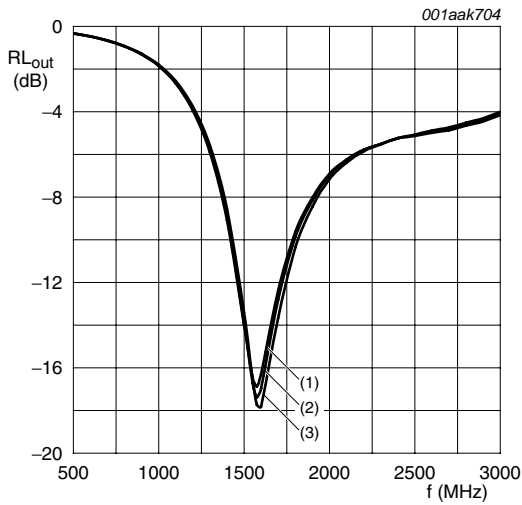

$P_i = -45 \text{ dBm}$ ;  $T_{\text{amb}} = 25 \text{ }^\circ\text{C}$ .  
 (1)  $V_{\text{CC}} = 1.5 \text{ V}$   
 (2)  $V_{\text{CC}} = 1.8 \text{ V}$   
 (3)  $V_{\text{CC}} = 2.85 \text{ V}$

**Fig 18. Output return loss as a function of frequency; typical values**

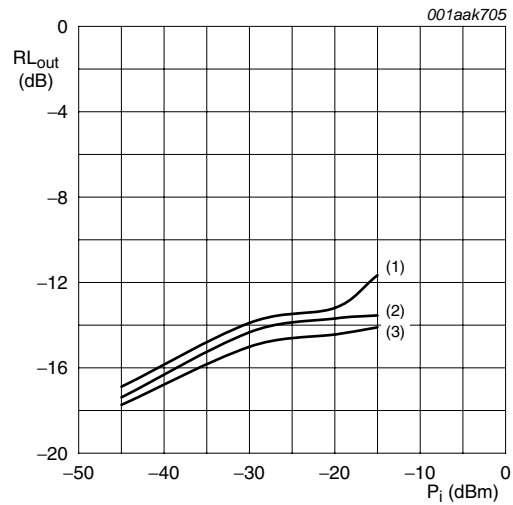

$T_{\text{amb}} = 25 \text{ }^\circ\text{C}$ ;  $f = 1575 \text{ MHz}$ .  
 (1)  $V_{\text{CC}} = 1.5 \text{ V}$   
 (2)  $V_{\text{CC}} = 1.8 \text{ V}$   
 (3)  $V_{\text{CC}} = 2.85 \text{ V}$

**Fig 19. Output return loss as a function of input power; typical values**

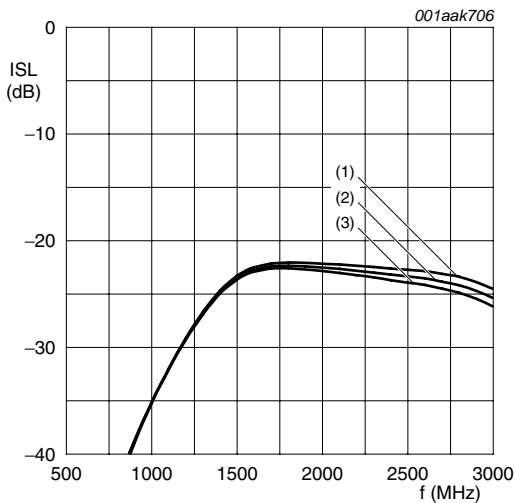

$V_{\text{CC}} = 1.8 \text{ V}$ ;  $P_i = -45 \text{ dBm}$ .  
 (1)  $T_{\text{amb}} = -40 \text{ }^\circ\text{C}$   
 (2)  $T_{\text{amb}} = +25 \text{ }^\circ\text{C}$   
 (3)  $T_{\text{amb}} = +85 \text{ }^\circ\text{C}$

**Fig 20. Isolation as a function of frequency; typical values**

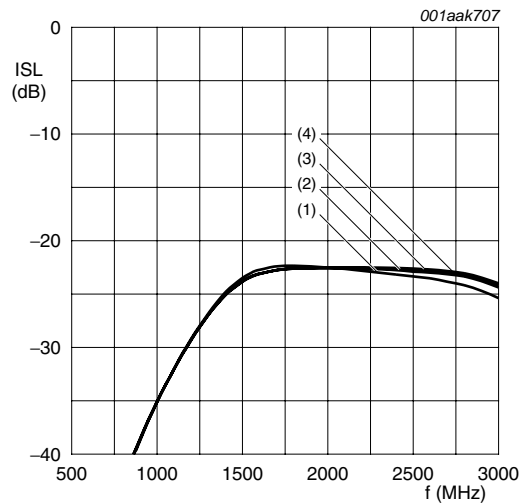

$V_{\text{CC}} = 1.8 \text{ V}$ ;  $T_{\text{amb}} = 25 \text{ }^\circ\text{C}$ .  
 (1)  $P_i = -45 \text{ dBm}$   
 (2)  $P_i = -30 \text{ dBm}$   
 (3)  $P_i = -20 \text{ dBm}$   
 (4)  $P_i = -15 \text{ dBm}$

**Fig 21. Isolation as a function of frequency; typical values**

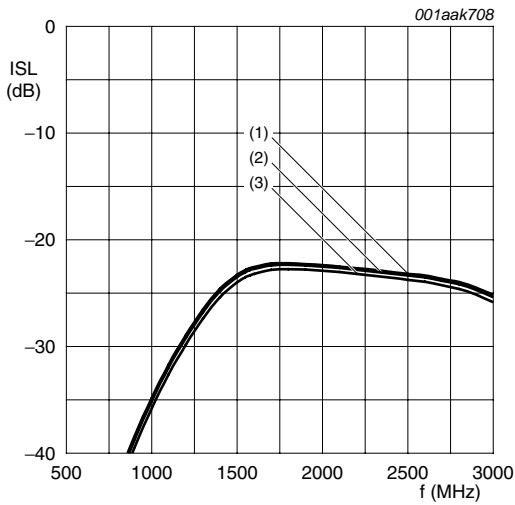

$P_i = -45 \text{ dBm}$ ;  $T_{\text{amb}} = 25 \text{ }^\circ\text{C}$ .  
 (1)  $V_{\text{CC}} = 1.5 \text{ V}$   
 (2)  $V_{\text{CC}} = 1.8 \text{ V}$   
 (3)  $V_{\text{CC}} = 2.85 \text{ V}$

**Fig 22. Isolation as a function of frequency; typical values**

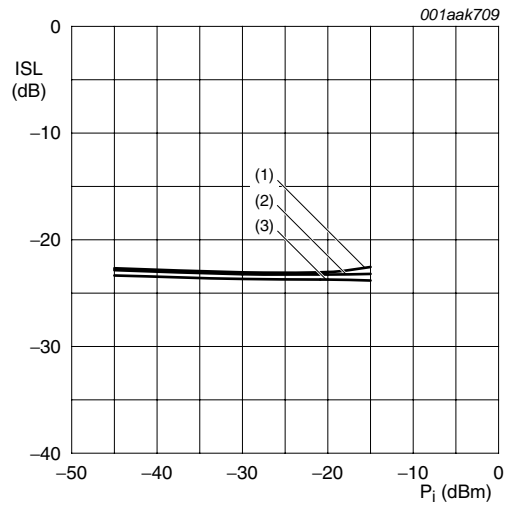

$T_{\text{amb}} = 25 \text{ }^\circ\text{C}$ ;  $f = 1575 \text{ MHz}$ .  
 (1)  $V_{\text{CC}} = 1.5 \text{ V}$   
 (2)  $V_{\text{CC}} = 1.8 \text{ V}$   
 (3)  $V_{\text{CC}} = 2.85 \text{ V}$

**Fig 23. Isolation as a function of input power; typical values**

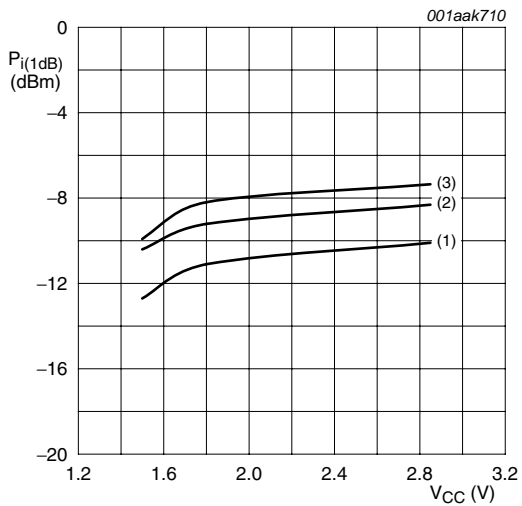

$f = 850 \text{ MHz}$ .  
 (1)  $T_{\text{amb}} = -40 \text{ }^\circ\text{C}$   
 (2)  $T_{\text{amb}} = +25 \text{ }^\circ\text{C}$   
 (3)  $T_{\text{amb}} = +85 \text{ }^\circ\text{C}$

**Fig 24. Input power at 1 dB gain compression as a function of supply voltage; typical values**

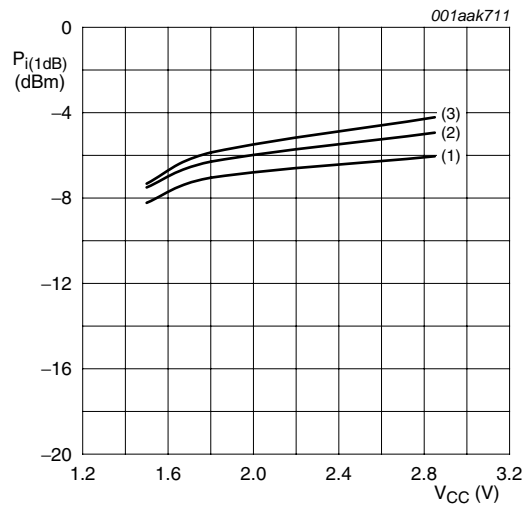

$f = 1850 \text{ MHz}$ .  
 (1)  $T_{\text{amb}} = -40 \text{ }^\circ\text{C}$   
 (2)  $T_{\text{amb}} = +25 \text{ }^\circ\text{C}$   
 (3)  $T_{\text{amb}} = +85 \text{ }^\circ\text{C}$

**Fig 25. Input power at 1 dB gain compression as a function of supply voltage; typical values**

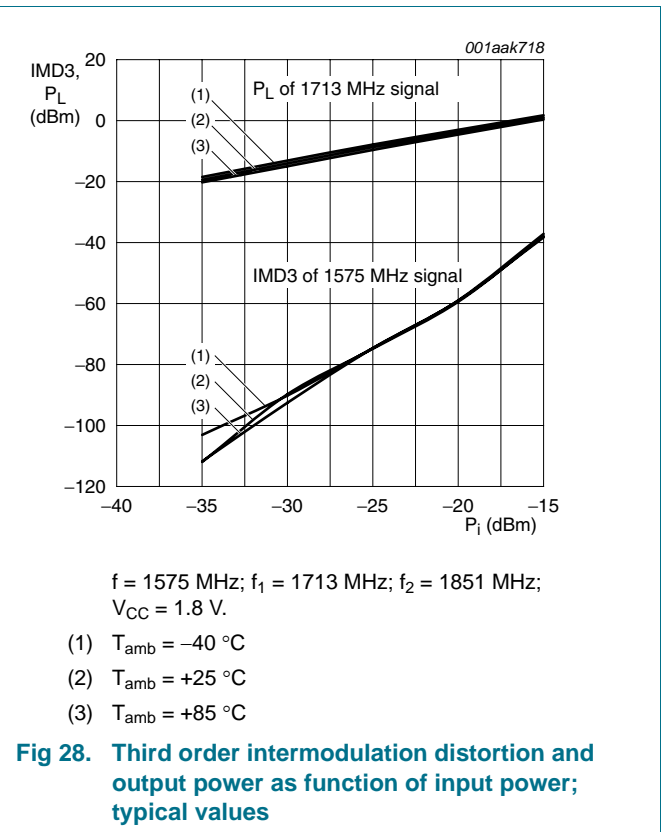
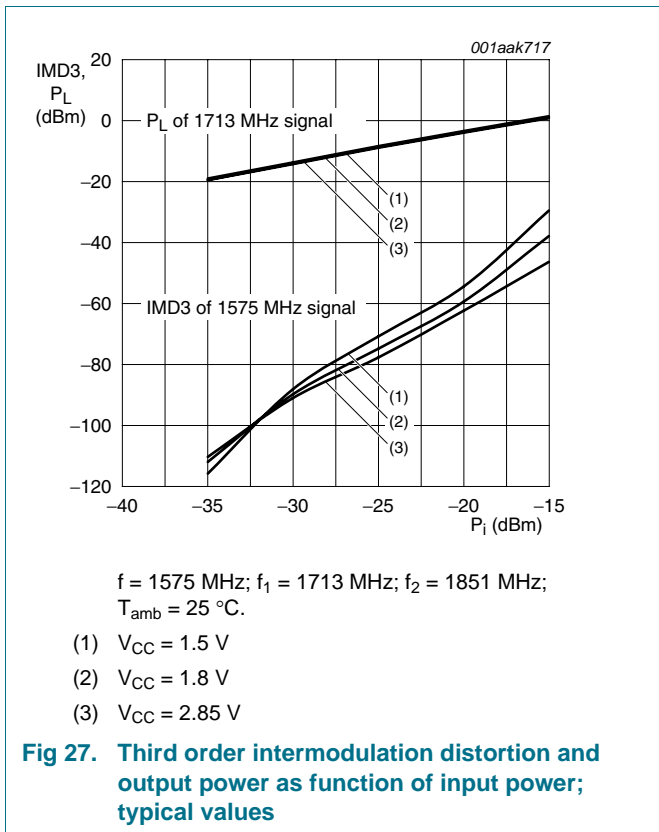
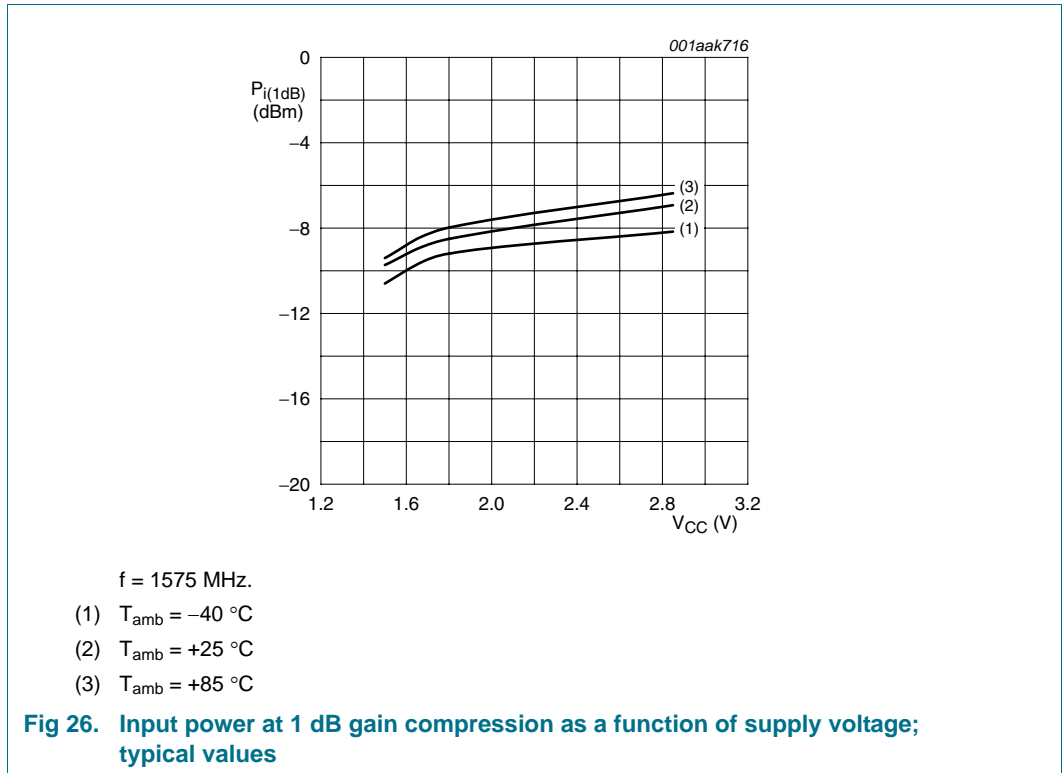

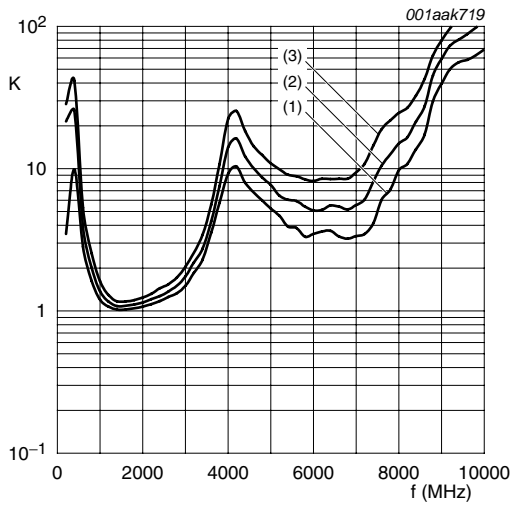

$T_{amb} = 25\text{ }^{\circ}\text{C}; P_i = -45\text{ dBm}.$   
 (1)  $V_{CC} = 1.5\text{ V}$   
 (2)  $V_{CC} = 1.8\text{ V}$   
 (3)  $V_{CC} = 2.85\text{ V}$

**Fig 29. Rollett stability factor as a function of frequency; typical values**

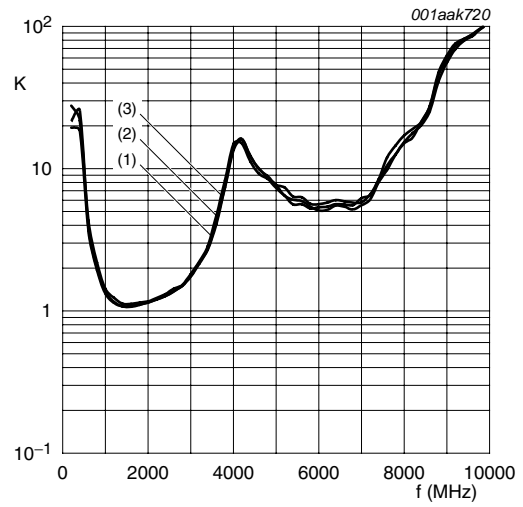

$V_{CC} = 1.8\text{ V}; P_i = -45\text{ dBm}.$   
 (1)  $T_{amb} = -40\text{ }^{\circ}\text{C}$   
 (2)  $T_{amb} = +25\text{ }^{\circ}\text{C}$   
 (3)  $T_{amb} = +85\text{ }^{\circ}\text{C}$

**Fig 30. Rollett stability factor as a function of frequency; typical values**

**8.2 GPS front-end**

The GPS LNA is typically used in a GPS front-end. A GPS front-end application circuit and its characteristics is provided here.

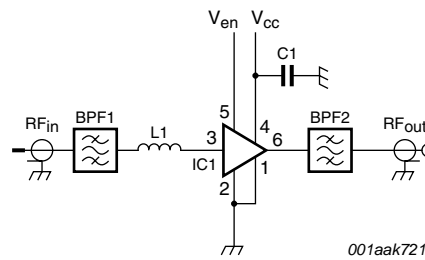

For a list of components see [Table 10](#).

**Fig 31. Schematics GPS front-end evaluation board**

**Table 10. List of components**For schematics see [Figure 31](#).

Component	Description	Value	Supplier	Remarks
BPF1, BPF2	GPS SAW filter	-	Murata SAFEA1G57KE0F00	Alternatives from Epcos: <ul style="list-style-type: none"> <li>• B9444</li> </ul> Alternatives from Murata: <ul style="list-style-type: none"> <li>• SAFEA1G57KH0F00</li> <li>• SAFEA1G57KB0F00</li> </ul> Alternatives from Fujitsu: <ul style="list-style-type: none"> <li>• FAR-F6KA-1G5754-L4AA</li> <li>• FAR-F6KA-1G5754-L4AJ</li> </ul>
C1	decoupling capacitor	1 nF	Various	
IC1	BGU7005	-	NXP	
L1	high quality matching inductor	5.6 nH	Murata LQW15A	

### 8.3 Characteristics GPS front-end

**Table 11. Characteristics GPS front-end**

$f = 1575$  MHz;  $V_{CC} = 1.8$  V;  $V_{ENABLE} \geq 0.8$  V; power at LNA input  $P_i < -40$  dBm;  $T_{amb} = 25$  °C; input and output matched to  $50 \Omega$ ; unless otherwise specified.

Symbol	Parameter	Conditions	Min	Typ	Max	Unit	
$V_{CC}$	supply voltage	RF input AC coupled	1.5	-	2.85	V	
$I_{CC}$	supply current		-	4.5	-	mA	
$T_{amb}$	ambient temperature		-40	+25	+85	°C	
$G_p$	power gain	power at LNA input $P_i < -40$ dBm	[1]	-	14.5	-	dB
		power at LNA input $P_i = -20$ dBm	[1]	-	15.5	-	dB
$RL_{in}$	input return loss	power at LNA input $P_i < -40$ dBm	[1]	-	8.5	-	dB
		power at LNA input $P_i = -20$ dBm	[1]	-	10.5	-	dB
$RL_{out}$	output return loss	power at LNA input $P_i < -40$ dBm	[1]	-	14.5	-	dB
		power at LNA input $P_i = -20$ dBm	[1]	-	12.5	-	dB
NF	noise figure	power at LNA input $P_i < -40$ dBm	[1]	-	1.8	-	dB
		power at LNA input $P_i = -20$ dBm	[1]	-	1.9	-	dB
$P_{i(1dB)}$	input power at 1 dB gain compression	$f = 1575$ MHz		-8.2		dBm	
		$f = 806$ MHz to $928$ MHz	[2]	31		dBm	
		$f = 1612$ MHz to $1909$ MHz	[2]	40		dBm	
$IP3_i$	input third-order intercept point		[3]	64		dBm	
$\alpha$	attenuation	$f = 850$ MHz	[4]	95	-	-	dBc
		$f = 1850$ MHz	[4]	90	-	-	dBc
$t_{on}$	turn-on time		[5]	-	2	$\mu$ s	
$t_{off}$	turn-off time		[5]	-	1	$\mu$ s	

[1] Power at GPS front-end input = power at LNA input + attenuation BPF1.

[2] Out of band.

[3]  $f_1 = 1713$  MHz;  $f_2 = 1851$  MHz.[4] Relative to  $f = 1575$  MHz.

[5] Within 10 % of the final gain.

## 9. Package outline

XSON6: plastic extremely thin small outline package; no leads; 6 terminals; body 1 x 1.45 x 0.5 mm

SOT886

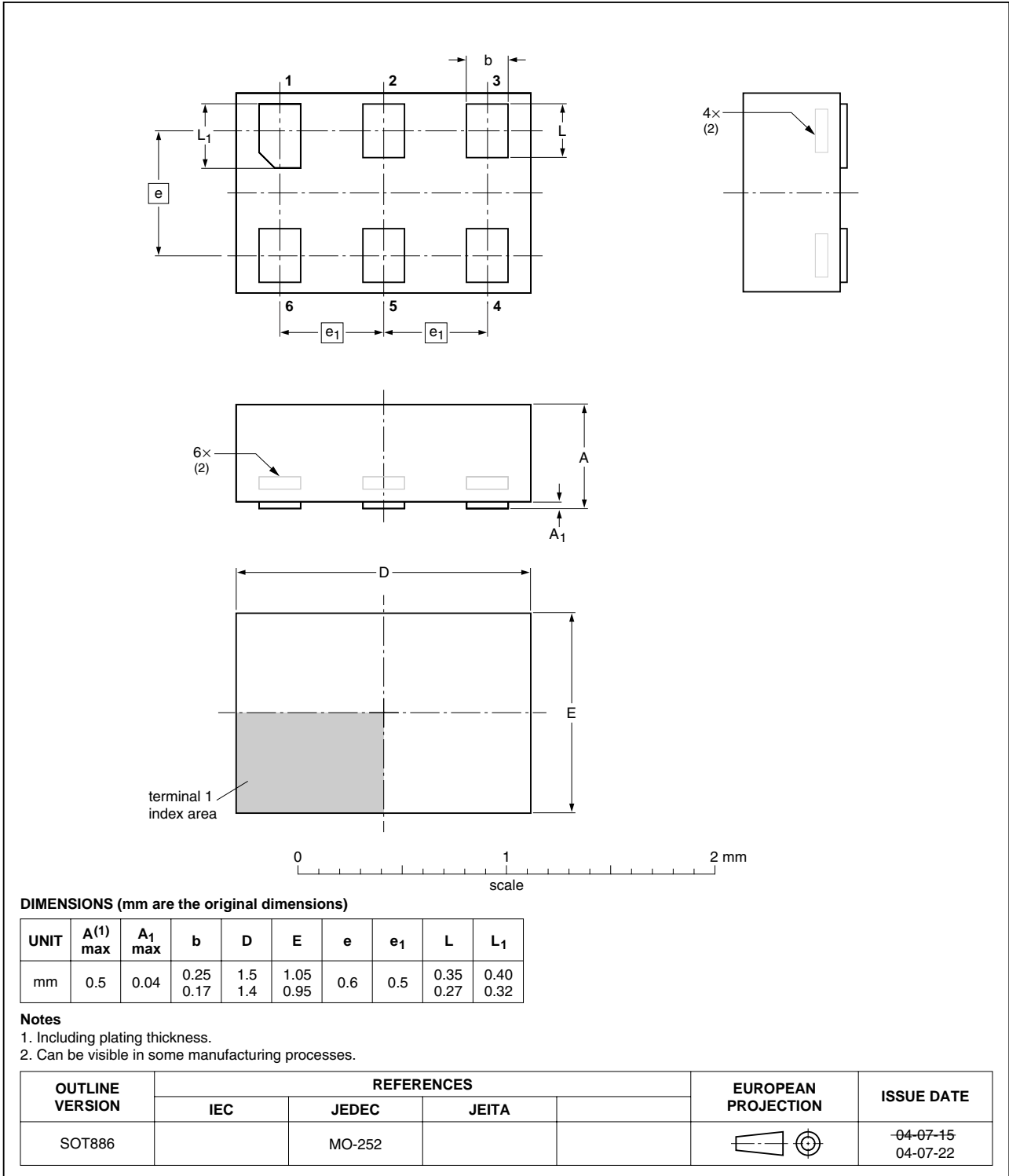

Fig 32. Package outline SOT886 (XSON6)

## 10. Abbreviations

Table 12. Abbreviations

Acronym	Description
AC	Alternating Current
FM	Frequency Modulation
GPS	Global Positioning System
HBM	Human Body Model
LNA	Low Noise Amplifier
MMIC	Monolithic Microwave Integrated Circuit
PDA	Personal Digital Assistant
RF	Radio Frequency
SAW	Surface Acoustic Wave
SiGe:C	Silicon Germanium Carbon

## 11. Revision history

Table 13. Revision history

Document ID	Release date	Data sheet status	Change notice	Supersedes
BGU7005_2	20100304	Product data sheet	-	BGU7005_1
Modifications:	<ul style="list-style-type: none"> <li>The status of this document has been changed into "Product data sheet".</li> <li><a href="#">Table 7 on page 3</a>: The values for ISL have been changed.</li> </ul>			
BGU7005_1	20091028	Preliminary data sheet	-	-



## 12. Legal information

### 12.1 Data sheet status

Document status <sup>[1][2]</sup>	Product status <sup>[3]</sup>	Definition
Objective [short] data sheet	Development	This document contains data from the objective specification for product development.
Preliminary [short] data sheet	Qualification	This document contains data from the preliminary specification.
Product [short] data sheet	Production	This document contains the product specification.

[1] Please consult the most recently issued document before initiating or completing a design.

[2] The term 'short data sheet' is explained in section "Definitions".

[3] The product status of device(s) described in this document may have changed since this document was published and may differ in case of multiple devices. The latest product status information is available on the Internet at URL <http://www.nxp.com>.

### 12.2 Definitions

**Draft** — The document is a draft version only. The content is still under internal review and subject to formal approval, which may result in modifications or additions. NXP Semiconductors does not give any representations or warranties as to the accuracy or completeness of information included herein and shall have no liability for the consequences of use of such information.

**Short data sheet** — A short data sheet is an extract from a full data sheet with the same product type number(s) and title. A short data sheet is intended for quick reference only and should not be relied upon to contain detailed and full information. For detailed and full information see the relevant full data sheet, which is available on request via the local NXP Semiconductors sales office. In case of any inconsistency or conflict with the short data sheet, the full data sheet shall prevail.

**Product specification** — The information and data provided in a Product data sheet shall define the specification of the product as agreed between NXP Semiconductors and its customer, unless NXP Semiconductors and customer have explicitly agreed otherwise in writing. In no event however, shall an agreement be valid in which the NXP Semiconductors product is deemed to offer functions and qualities beyond those described in the Product data sheet.

### 12.3 Disclaimers

**Limited warranty and liability** — Information in this document is believed to be accurate and reliable. However, NXP Semiconductors does not give any representations or warranties, expressed or implied, as to the accuracy or completeness of such information and shall have no liability for the consequences of use of such information.

In no event shall NXP Semiconductors be liable for any indirect, incidental, punitive, special or consequential damages (including - without limitation - lost profits, lost savings, business interruption, costs related to the removal or replacement of any products or rework charges) whether or not such damages are based on tort (including negligence), warranty, breach of contract or any other legal theory.

Notwithstanding any damages that customer might incur for any reason whatsoever, NXP Semiconductors' aggregate and cumulative liability towards customer for the products described herein shall be limited in accordance with the *Terms and conditions of commercial sale* of NXP Semiconductors.

**Right to make changes** — NXP Semiconductors reserves the right to make changes to information published in this document, including without limitation specifications and product descriptions, at any time and without notice. This document supersedes and replaces all information supplied prior to the publication hereof.

**Suitability for use** — NXP Semiconductors products are not designed, authorized or warranted to be suitable for use in medical, military, aircraft, space or life support equipment, nor in applications where failure or

malfunction of an NXP Semiconductors product can reasonably be expected to result in personal injury, death or severe property or environmental damage. NXP Semiconductors accepts no liability for inclusion and/or use of NXP Semiconductors products in such equipment or applications and therefore such inclusion and/or use is at the customer's own risk.

**Applications** — Applications that are described herein for any of these products are for illustrative purposes only. NXP Semiconductors makes no representation or warranty that such applications will be suitable for the specified use without further testing or modification.

NXP Semiconductors does not accept any liability related to any default, damage, costs or problem which is based on a weakness or default in the customer application/use or the application/use of customer's third party customer(s) (hereinafter both referred to as "Application"). It is customer's sole responsibility to check whether the NXP Semiconductors product is suitable and fit for the Application planned. Customer has to do all necessary testing for the Application in order to avoid a default of the Application and the product. NXP Semiconductors does not accept any liability in this respect.

**Limiting values** — Stress above one or more limiting values (as defined in the Absolute Maximum Ratings System of IEC 60134) will cause permanent damage to the device. Limiting values are stress ratings only and (proper) operation of the device at these or any other conditions above those given in the Recommended operating conditions section (if present) or the Characteristics sections of this document is not warranted. Constant or repeated exposure to limiting values will permanently and irreversibly affect the quality and reliability of the device.

**Terms and conditions of commercial sale** — NXP Semiconductors products are sold subject to the general terms and conditions of commercial sale, as published at <http://www.nxp.com/profile/terms>, unless otherwise agreed in a valid written individual agreement. In case an individual agreement is concluded only the terms and conditions of the respective agreement shall apply. NXP Semiconductors hereby expressly objects to applying the customer's general terms and conditions with regard to the purchase of NXP Semiconductors products by customer.

**No offer to sell or license** — Nothing in this document may be interpreted or construed as an offer to sell products that is open for acceptance or the grant, conveyance or implication of any license under any copyrights, patents or other industrial or intellectual property rights.

**Export control** — This document as well as the item(s) described herein may be subject to export control regulations. Export might require a prior authorization from national authorities.

**Non-automotive qualified products** — Unless this data sheet expressly states that this specific NXP Semiconductors product is automotive qualified, the product is not suitable for automotive use. It is neither qualified nor tested in accordance with automotive testing or application requirements. NXP Semiconductors accepts no liability for inclusion and/or use of non-automotive qualified products in automotive equipment or applications.

In the event that customer uses the product for design-in and use in automotive applications to automotive specifications and standards, customer (a) shall use the product without NXP Semiconductors' warranty of the

product for such automotive applications, use and specifications, and (b) whenever customer uses the product for automotive applications beyond NXP Semiconductors' specifications such use shall be solely at customer's own risk, and (c) customer fully indemnifies NXP Semiconductors for any liability, damages or failed product claims resulting from customer design and use of the product for automotive applications beyond NXP Semiconductors' standard warranty and NXP Semiconductors' product specifications.

**Quick reference data** — The Quick reference data is an extract of the product data given in the Limiting values and Characteristics sections of this document, and as such is not complete, exhaustive or legally binding.

## 12.4 Trademarks

Notice: All referenced brands, product names, service names and trademarks are the property of their respective owners.

## 13. Contact information

---

For more information, please visit: <http://www.nxp.com>

For sales office addresses, please send an email to: [salesaddresses@nxp.com](mailto:salesaddresses@nxp.com)

## 14. Contents

<b>1</b>	<b>Product profile</b> . . . . .	<b>1</b>
1.1	General description . . . . .	1
1.2	Features and benefits . . . . .	1
1.3	Applications . . . . .	1
1.4	Quick reference data . . . . .	2
<b>2</b>	<b>Pinning information</b> . . . . .	<b>2</b>
<b>3</b>	<b>Ordering information</b> . . . . .	<b>2</b>
<b>4</b>	<b>Marking</b> . . . . .	<b>3</b>
<b>5</b>	<b>Limiting values</b> . . . . .	<b>3</b>
<b>6</b>	<b>Thermal characteristics</b> . . . . .	<b>3</b>
<b>7</b>	<b>Characteristics</b> . . . . .	<b>3</b>
<b>8</b>	<b>Application information</b> . . . . .	<b>5</b>
8.1	GPS LNA . . . . .	5
8.2	GPS front-end . . . . .	13
8.3	Characteristics GPS front-end . . . . .	14
<b>9</b>	<b>Package outline</b> . . . . .	<b>15</b>
<b>10</b>	<b>Abbreviations</b> . . . . .	<b>16</b>
<b>11</b>	<b>Revision history</b> . . . . .	<b>16</b>
<b>12</b>	<b>Legal information</b> . . . . .	<b>17</b>
12.1	Data sheet status . . . . .	17
12.2	Definitions . . . . .	17
12.3	Disclaimers . . . . .	17
12.4	Trademarks . . . . .	18
<b>13</b>	<b>Contact information</b> . . . . .	<b>18</b>
<b>14</b>	<b>Contents</b> . . . . .	<b>19</b>

Please be aware that important notices concerning this document and the product(s) described herein, have been included in section 'Legal information'.

© NXP B.V. 2010.

All rights reserved.

For more information, please visit: <http://www.nxp.com>

For sales office addresses, please send an email to: [salesaddresses@nxp.com](mailto:salesaddresses@nxp.com)

Date of release: 4 March 2010

Document identifier: BGU7005\_2