

LM5035C Evaluation Board

National Semiconductor
Application Note 2043
Ajay Hari
March 18, 2010



Introduction

The LM5035C evaluation board is designed to provide the design engineer with a fully functional power converter based on the Half Bridge topology to evaluate the LM5035C controller. The LM5035C is a functional variant of the LM5035B Half-Bridge PWM Controller. The amplitude of the SR control signals are 5V instead of the V_{CC} level. The evaluation board is provided in an industry standard quarter-brick footprint.

The performance of the evaluation board is as follows:

- Input operating range: 36V to 75V
- Output voltage: 3.3V
- Output current: 0 to 30A
- Measured efficiency: 89% at 30A, 92% at 15A
- Frequency of operation: 400kHz
- Board size: 2.28 x 1.45 x 0.5 inches
- Load Regulation: 0.2%
- Line Regulation: 0.1%
- Line UVLO (33.9V/31.9V on/off)
- Line OVP (79.4V/78.3V off/on)
- Hiccup current limit

The printed circuit board consists of 6 layers; 2 ounce copper outer layers and 3 ounce copper inner layers on FR4 material with a total thickness of 0.062 inches. The unit is designed for continuous operation at rated load at $<40^{\circ}\text{C}$ and a minimum airflow of 200 CFM.

Theory of Operation

Power converters based on the Half Bridge topology offer high efficiency and good power handling capability in applications up to 500 Watts. The operation of the transformer causes the flux to swing in both directions, thereby better utilizing the magnetic core.

The Half Bridge converter is derived from the Buck topology family, employing separate high voltage (HO) and low voltage

(LO) modulating power switches with independent pulse width timing. The main difference between the topologies are, the Half Bridge topology employs a transformer to provide input / output ground isolation and a step down or step up function.

Each cycle, the main primary switch turns on and applies one-half the input voltage across the primary winding, which has 8 turns. The transformer secondary has 2 turns, leading to a 4:1 step-down of the input voltage. For an output voltage of 3.3V the composite duty cycle (D) of the primary switches varies from approximately 75% (low line) to 35% (high line).

The secondary employs synchronous rectification controlled by the LM5035C. During soft-start, the sync FET body diodes act as the secondary rectifiers until the main transformer energizes the gate drivers. The DLY resistor programs the non-overlap timing for the sync FETs to maximize efficiency while eliminating shoot through current. The Sync FET control signals are sent across the isolation boundary using a digital isolator.

Feedback from the output is processed by an amplifier and reference, generating an error voltage, which is coupled back to the primary side control through an optocoupler. The COMP input to the LM5035C greatly increases the achievable loop bandwidth. The capacitance effect (and associated pole) of the optocoupler is reduced by holding the voltage across the optocoupler constant. The LM5035C voltage mode controller pulse width modulates the error signal with a ramp signal derived from the line voltage (feedforwarding) to reduce the response time to input voltage changes. A standard "type III" network is used for the compensator.

The evaluation board can be synchronized to an external clock with a recommended frequency range of 420KHz to 500KHz.

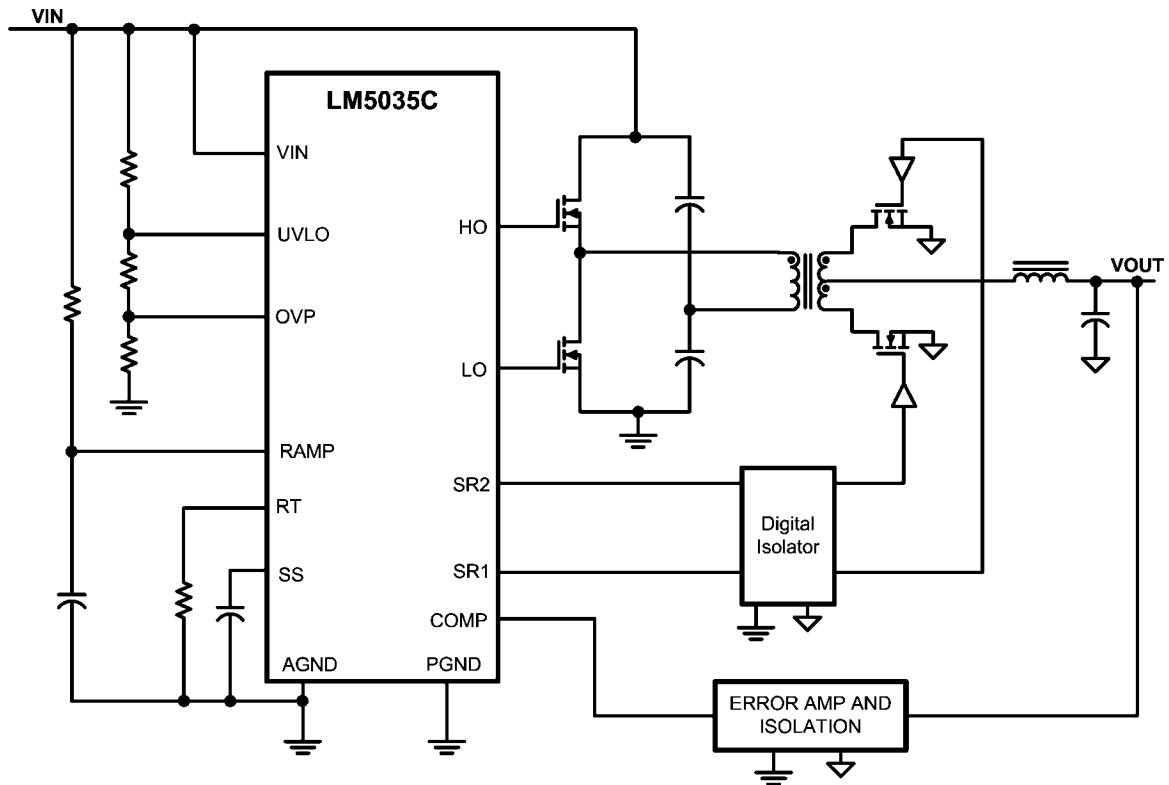

Simplified Half Bridge Converter

30119501

Powering and Loading Considerations

When applying power to the LM5035C evaluation board certain precautions need to be followed. A misconnection can damage the assembly.

Proper Connections

When operated at low input voltages the evaluation board can draw up to 3.5A of current at full load. The maximum rated output current is 30A. Be sure to choose the correct connector and wire size when attaching the source supply and the load. Monitor the current into and out of the evaluation board. Monitor the voltage directly at the output terminals of the evaluation board. The voltage drop across the load connecting wires will cause inaccurate measurements. This is especially true for accurate efficiency measurements.

Source Power

The evaluation board can be viewed as a constant power load. At low input line voltage (36V) the input current can reach 3.5A, while at high input line voltage (75V) the input current will be approximately 1.5A. Therefore, to fully test the LM5035C evaluation board a DC power supply capable of at least 85V and 5A is required.

The power supply must have adjustments for both voltage and current. The power supply and cabling must present low impedance to the evaluation board. Insufficient cabling or a high impedance power supply will cause voltage droop during turn-on due to the evaluation board inrush current. If large enough, this droop will cause a chattering condition upon power up. This chattering condition is an interaction with the

evaluation board undervoltage lockout, the cabling impedance and the inrush current.

Loading

An appropriate electronic load, with specified operation down to 1.0V minimum, is desirable. The resistance of a maximum load is 0.11Ω. The high output current requires thick cables! If resistor banks are used there are certain precautions to be taken. The wattage and current ratings must be adequate for a 30A, 100W supply. Monitor both current and voltage at all times. Ensure there is sufficient cooling provided for the load.

Air Flow

Full power loading should never be attempted without providing the specified 200 CFM of air flow over the evaluation board. A stand-alone fan should be provided.

Powering Up

Using the ON/OFF pin (J2) provided will allow powering up the source supply with the current level set low. It is suggested that the load be kept low during the first power up. Set the current limit of the source supply to provide about 1.5 times the wattage of the load. As you remove the connection from the ON/OFF pin to ground (J1), immediately check for 3.3 volts at the output.

A most common occurrence, that will prove unnerving, is when the current limit set on the source supply is insufficient for the load. The result is similar to having the high source impedance referred to earlier. The interaction of the source supply folding back and the evaluation board going into undervoltage shutdown will start an oscillation, or chatter, that may have undesirable consequences.

A quick efficiency check is the best way to confirm that everything is operating properly. If something is amiss you can be reasonably sure that it will affect the efficiency adversely. Few parameters can be incorrect in a switching power supply without creating losses and potentially damaging heat.

35A) the unit will discharge the softstart capacitor, which disables the power stage. After a delay the softstart is released. The shutdown, delay and slow recharge time of the softstart capacitor protects the unit, especially during short circuit event where the stress is highest.

Over Current Protection

The evaluation board is configured with hiccup over-current protection. In the event of an output overload (approximately

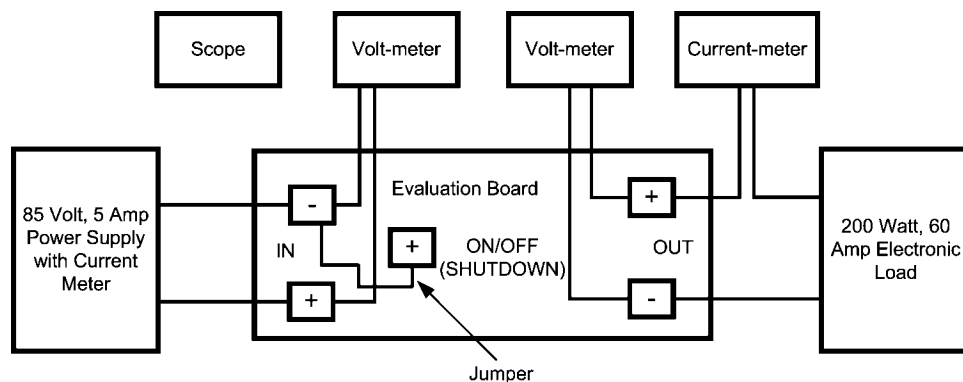

30119502

Typical Evaluation Setup

Digital Isolator

There is a total of four crossing of the isolation boundary; the power transformer, the feedback and control of the two synchronous MOSFETs. Usually an opto-coupler is used for isolation of the feedback signal since this a relatively slow analog signal. Most opto-couplers are too slow to use for the synchronous MOSFET gate drive. There are fast opto-couplers available but there is a big cost premium. Historically, the most common approach has been to use gate drive transformers to provide isolation for the synchronous gate drive signals. The transformers can be used to directly drive the MOSFET gates or the transformers can be used to just isolate the control signal which is then applied to a gate driver IC on the secondary side. Gate drive transformers have their challenges and limitations. Transformers cannot pass DC. A given size transformer can only pass a finite voltage & time product across the isolation boundary. After each on-time, the trans-

former needs to be reset, which imposes duty cycle limitations. Further, during a sudden switch-off of the power converter, the DC restorer capacitor on the secondary of the gate drive transformer does not have a quick discharge path. This will keep SR FET's turned on, resulting in a non-monotonic decay of the output voltage.

These limitations can be addressed using a digital isolator. The digital isolators are CMOS devices that use an RF coupler to transmit digital information across the isolation barrier. The isolation capability is up to 2500 VRMS. In simple words, the digital isolators are similar to an opto-coupler. While, the opto-couplers modulate light to transmit electrical signals, the digital isolators modulate an RF signal across a semiconductor barrier. Furthermore, the digital isolators have lower propagation delay than the gate drive transformers and do not suffer volt-second limitations.

Performance Characteristics

TURN-ON WAVEFORMS

When applying power to the LM5035C evaluation board a certain sequence of events occurs. Soft-start capacitor values and other components allow for a minimal output voltage for a short time until the feedback loop can stabilize without overshoot. Figure 1 shows the output voltage during a typical start-up with a 48V input and a load of 5A. There is no overshoot during startup.

OUTPUT RIPPLE WAVEFORMS

Figure 2 shows the transient response for a load change from 15A to 22.5A. The upper trace shows minimal output voltage droop and overshoot during the sudden change in output current shown by the lower trace.

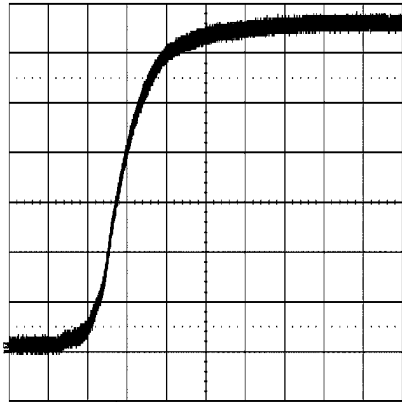

30119504

Conditions: Input Voltage = 48VDC
Output Current = 5A
Trace 1: Output Voltage Volts/div = 500mV
Horizontal Resolution = 0.5ms/div

FIGURE 1.

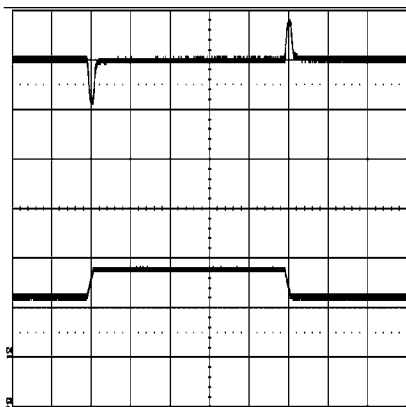

30119505

Conditions: Input Voltage = 48VDC
Output Current = 15A to 22.5A
Upper Trace: Output Voltage Volts/div = 50mV
Lower Trace: Output Current = 15A to 22.5A to 15A
Horizontal Resolution = 0.5ms/div

FIGURE 2.

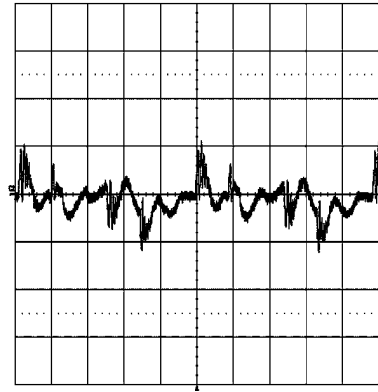

30119506

Conditions: Input Voltage = 48VDC
Output Current = 30A
Bandwidth Limit = 20MHz
Trace 1: Output Ripple Voltage Volts/div = 20mV
Horizontal Resolution = 1μs/div

FIGURE 3.

Figure 3 shows typical output ripple seen across the output terminals (with standard 10μF and 1μF ceramic capacitors) for an input voltage of 48V and a load of 30A. This waveform is typical of most loads and input voltages.

Figures 4 and 5 show the drain voltage of Q1 with a 5A load. Figure 4 represents an input voltage of 36V and Figure 5 represents an input voltage of 72V.

Figure 6 shows the gate voltages of the synchronous rectifiers. The deadtime provided by the 20kΩ DLY resistor is difficult to see at this timescale.

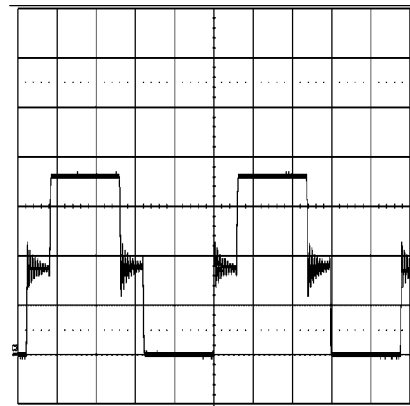

30119507

Conditions: Input Voltage = 36VDC
Output Current = 5A
Trace 1: Q1 drain voltage Volts/div = 10V
Horizontal Resolution = 1μs/div

FIGURE 4.

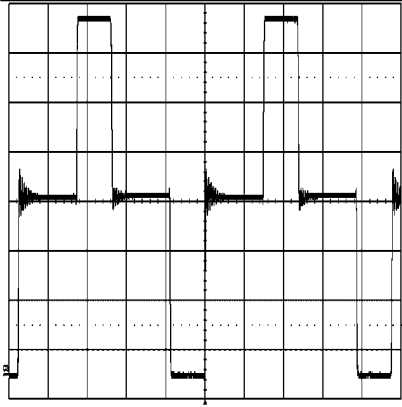

30119508

Conditions: Input Voltage = 72VDC
 Output Current = 5A
 Trace 1: Q2 drain voltage Volts/div = 10V
 Horizontal Resolution = 1 μ s/div

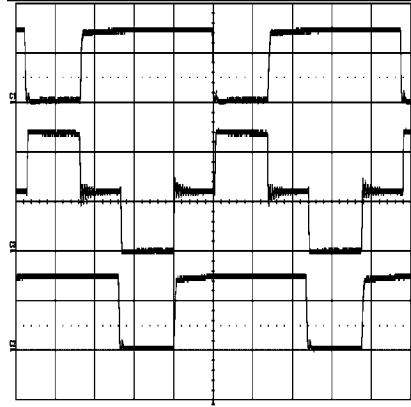
FIGURE 5.

30119509

Conditions: Input Voltage = 48VDC
 Output Current = 5A
 Upper Trace: SR1, Q4 gate Volts/div = 5V
 Middle Trace: HS, Q2 drain Volts/div = 20V
 Lower Trace: SR2, Q6 gate Volts/div = 5V
 Horizontal Resolution = 1 μ s/div

FIGURE 6.

Item	Part Description	Qty	Ref Designator	Remark
1	LM5035C Controller MH20	1	U1	NSC LM5035CMH
2	LM5110-1M Dual Driver	1	U2	NSC LM5110-1M
3	LM8261M5 Op Amp SOT23-5	1	U3	NSC LM8261M5
4	LM4041AIM3-1.2 Ref Amp SOT23	1	U5	NSC LM4041AIM3-.12
5	Opto-Coupler PS2811-1M	1	U4	NEC PS2811-1M
6	Digital Isolator IC SOIC-8	1	U6	Silicon Labs SI8420BB-D
7	Cer Cap 47pF 50V COG 0603	1	C21	TDK C1608COG1H470J
8	Cer Cap 150pF 50V COG 0603	1	C26	TDK C1608COG1H151J
9	Cer Cap 470pF 50V COG 0603	1	C34	TDK C1608COG1H471J
10	Cer Cap 1000pF 50V X7R 0603	2	C19, C37	TDK C1608X7R1H102K
11	Cer Cap 2000pF 50V COG 0603	2	C27, C32	TDK C1608COG1H222J
12	Cer Cap 6800pF 50V COG 0603	1	C28	TDK C1608COG1H682J
13	Cer Cap 0.022uF 25V COG 0603	1	C35	TDK C1608COG1E223J
14	Cer Cap 0.1uF 50V X7R 0603	3	C2, C33, C36	TDK C1608X7R1H104K
15	Cer Cap 1.0uF 16V X7R 0603	2	C25, C31, C29, C20	TDK C1608X7R1C105K
16	Cer Cap 470pF 50V COG 0805	2	C15, C16	KEMT C0805C471M5RAC
17	Cer Cap 0.1uF 100V X7R 0805	2	C17, C24	TDK C2012X7R2A104K
18	Cer Cap 0.33uF 50V X7R 0805	1	C7	TDK C2012X7R1H334K
19	Cer Cap 2.2uF 16V X7R 0805	2	C1, C22	TDK C2012X7R1C225K
20	Cer Cap 4.7uF 16V X7R 1206	1	C18	TDK C3216X7R1C475K
21	Cer Cap 22uF 6.3V X5R 1206	4	C11-C14	TDK C3216X5R0J226M
22	Cer Cap 2200pF 2000V X7R 1812	1	C38	TDK C4532X7R3D222K
23	Cer Cap 6.8uF 50V X7R 1812	4	C3-C6	TDK C4532X7R1H685M
24	POSCAP 220uF 6.3V	3	C8-C10	Sanyo 6TPE220MI
25	Res 2.8 Ohm 0.1W 1% 0603	1	R12	Vishay CRCW06032R80F
26	Res 10 Ohm 0.1W 1% 0603	2	R17, R35	Vishay CRCW060310R0F
27	Res 100 Ohm 0.1W 1% 0603	3	R25, R27	Vishay CRCW06031000F
28	Res 549 Ohm 0.1W 1% 0603	1	R21	Vishay CRCW06035490F
29	Res 1K Ohm 0.1W 1% 0603	4	R13, R18	Vishay CRCW06031001F
30	Res 1.58K Ohm 0.1W 1% 0603	1	R24	Vishay CRCW06031581F
31	Res 2.0K Ohm 0.1W 1% 0603	1	R31	Vishay CRCW06032001F
32	Res 4.12K Ohm 0.1W 1% 0603	1	R20	Vishay CRCW06034121F
33	Res 5.11K Ohm 0.1W 1% 0603	1	R32	Vishay CRCW06035111F
34	Res 8.06K Ohm 0.1W 1% 0603	1	R22	Vishay CRCW06038061F
35	Res 10K Ohm 0.1W 1% 0603	2	R7, R30	Vishay CRCW06031002F
36	Res 10.2K Ohm 0.1W 1% 0603	1	R26	Vishay CRCW06031022F
37	Res 14.7K Ohm 0.1W 1% 0603	1	R33, R46	Vishay CRCW06031472F

Item	Part Description	Qty	Ref Designator	Remark
38	Res 15K Ohm 0.1W 1% 0603	1	R29, R41	Vishay CRCW06031502F
39	Res 20K Ohm 0.1W 1% 0603	1	R34	Vishay CRCW06032002F
40	Res 25.5K Ohm 0.1W 1% 0603	1	R23	Vishay CRCW06032552F
41	Res 100K Ohm 0.1W 1% 0603	2	R3, R4	Vishay CRCW06031003F
42	NU 0805	1	R14	NU
43	Res 10 OHM 1/10W 1% 0805	3	R1, R11, R15	Vishay CRCW080510R0F
44	Res 49.9 OHM 1/10W 1% 0805	1	R5	Vishay CRCW080549R9F
45	Res 2K OHM 1/10W 1% 0805	1	R2, R19	Vishay CRCW08052001F
46	Res 10K OHM 1/10W 1% 0805	1	R6	Vishay CRCW08051002F
47	Res 64.9K OHM 1/10W 1% 0805	1	R16	Vishay CRCW08056492F
48	Res 100K OHM 1/10W 1% 0805	2	R10, R36	Vishay CRCW08051003F
49	Res 10 OHM 1% 2010	2	R8, R9	Vishay CRCW201010R0F
50	Schottky, Diode, 75V 150mA SOT23	1	D1	BAV70-TP
51	Diode, 75V 250mA SOD-323	2	D2, D4	Central CMDD4448
52	Diodes, Rectifier, Bridge, 30V	1	BR1	BAT54BRW
53	Zener 8.2V 5% SOT23	1	Z1	Central CMPZ4694
54	Zener 11V 5% SOT23	1	Z2	Central CMPZ4698
55	Zener 5.6V, 5% SOT23	1	Z4	Central CMPZ4690
	NU SOT23	1	Z3	NU
56	N-FET 100V 25m ohm	2	Q1, Q2	Vishay Si7456DP
57	N-FET 30V 3m ohm	4	Q4-7	Vishay Si7336ADP
58	NPN, ZETEX 45V 2A	2	Q3, Q8	ZETEX FCX690B
59	NPN, ON SEMI 45V, 225mW	1	Q10	MMBT6429LT1G
60	NU	1	Q9	NU
61	Inductor 2.2uH 5.4A	1	L1	TDK RLF7030T-2R2M5R4
62	Inductor 1.2uH 37A	1	L2	Coilcraft SER2010-122MX
63	Transformer 8:5:2:2	1	T1	Coilcraft DA2025-AL
64	Current XFR 100:1, 10A	1	T2	Pulse Engr P8208
65	Test Pin, Brick 0.040X0.5	6	J1-3, J5-7	Mill-Max 3104-2-00-80-00-00-08-0
66	Test Pin, Brick 0.080X0.375	2	J4, J8	Mill-Max 3231-2-00-01-00-00-08-0

PCB Layouts

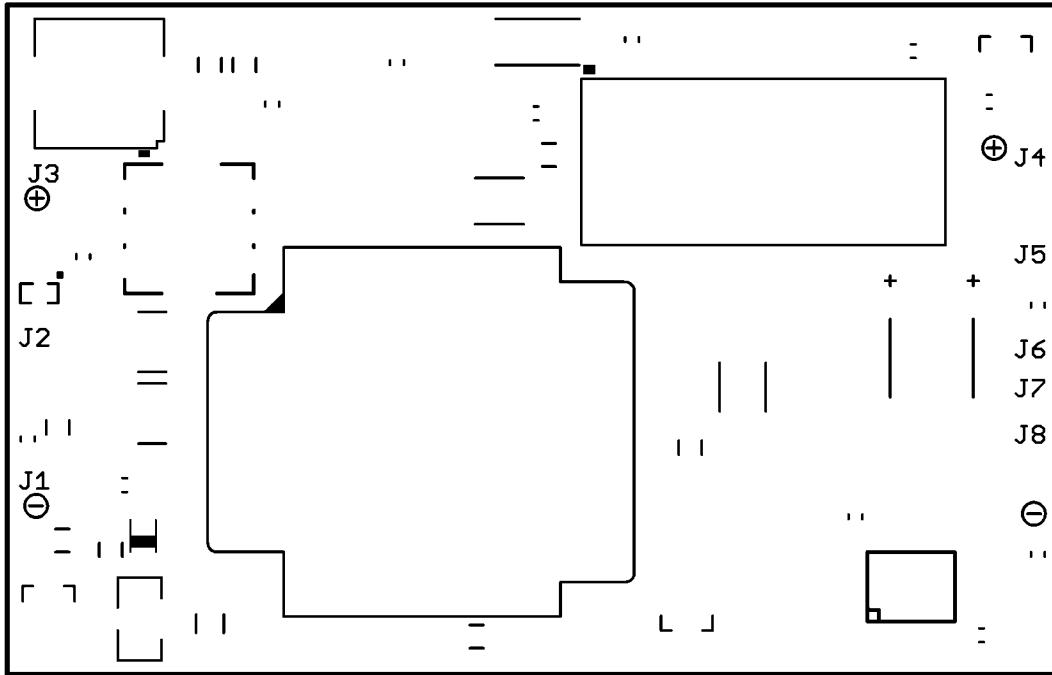

Top Side

30119510

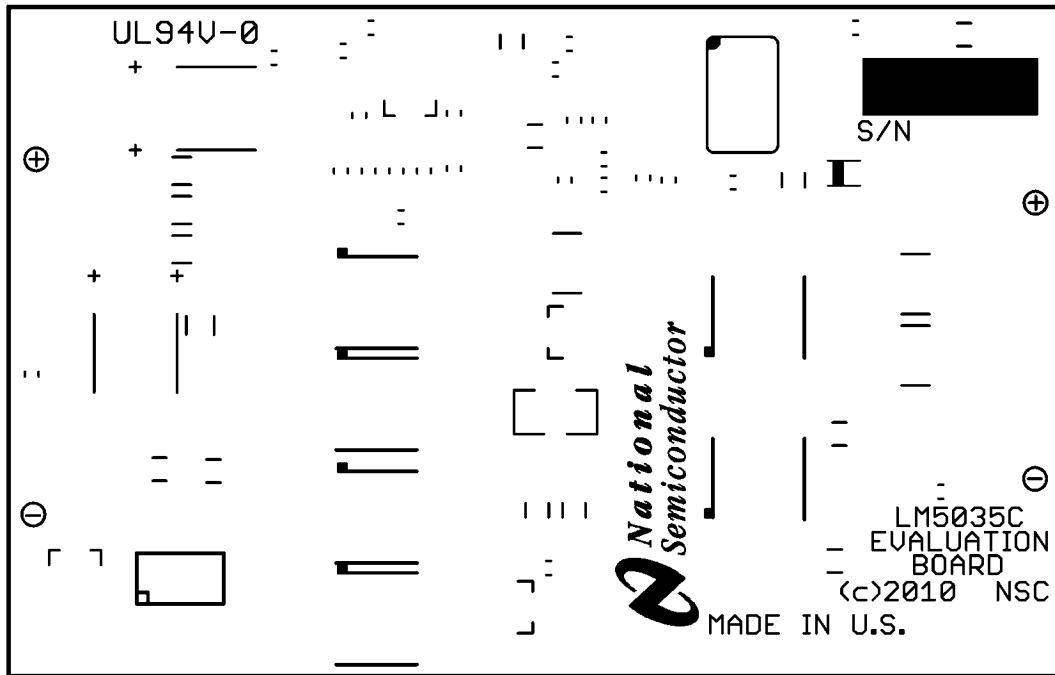

Bottom Side

30119511

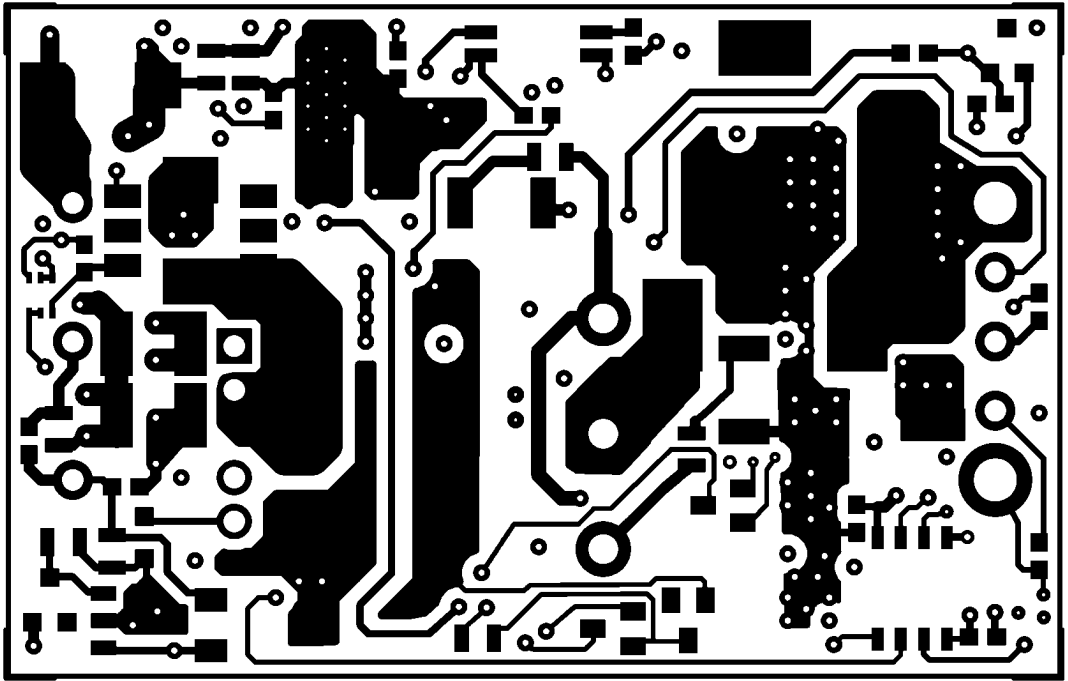

Layer 1

30119512

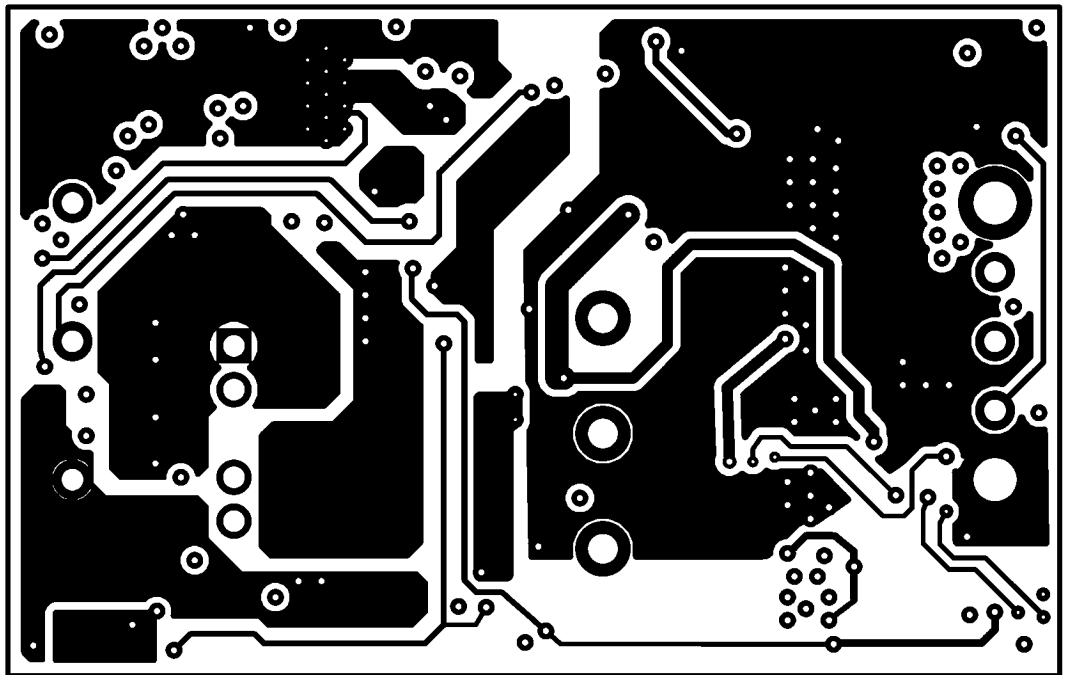

Layer 2

30119513

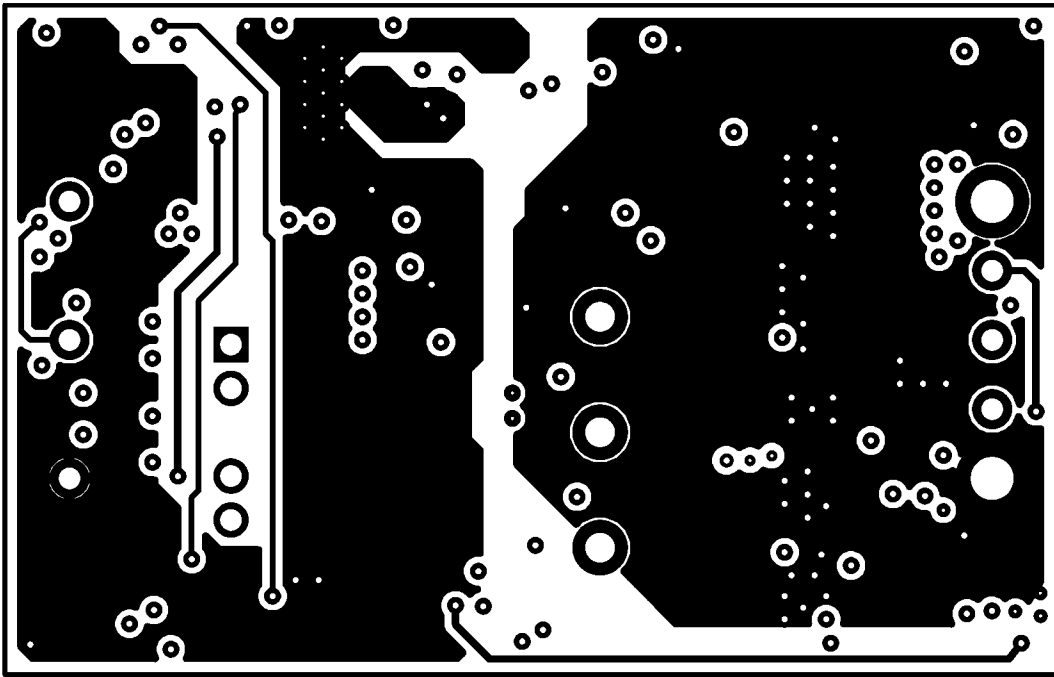

Layer 3

30119514

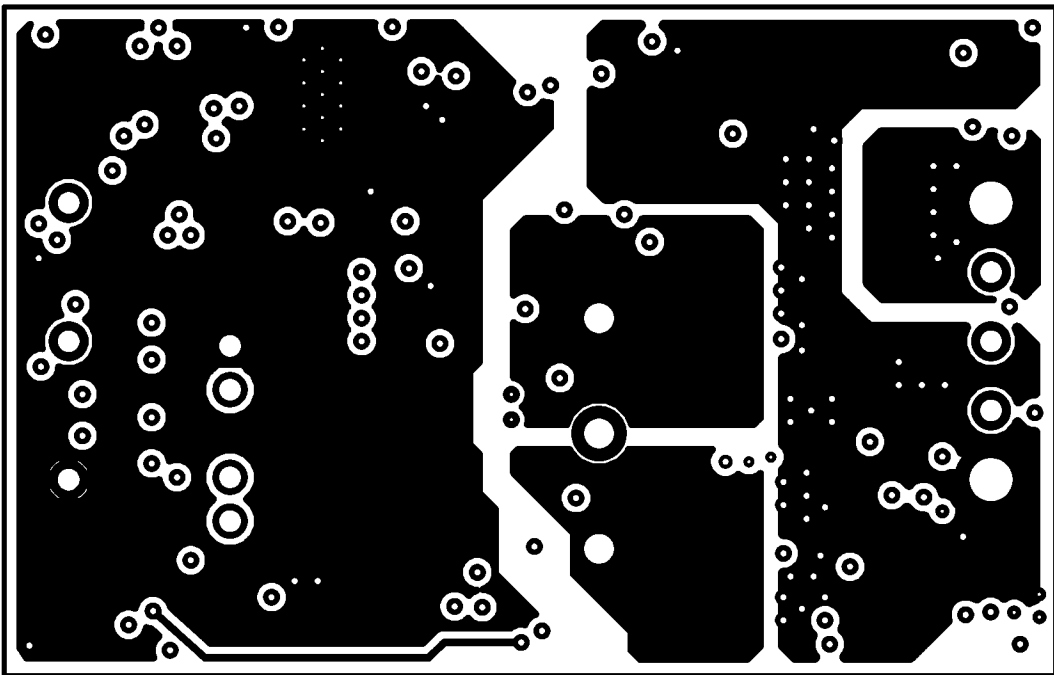

Layer 4

30119515

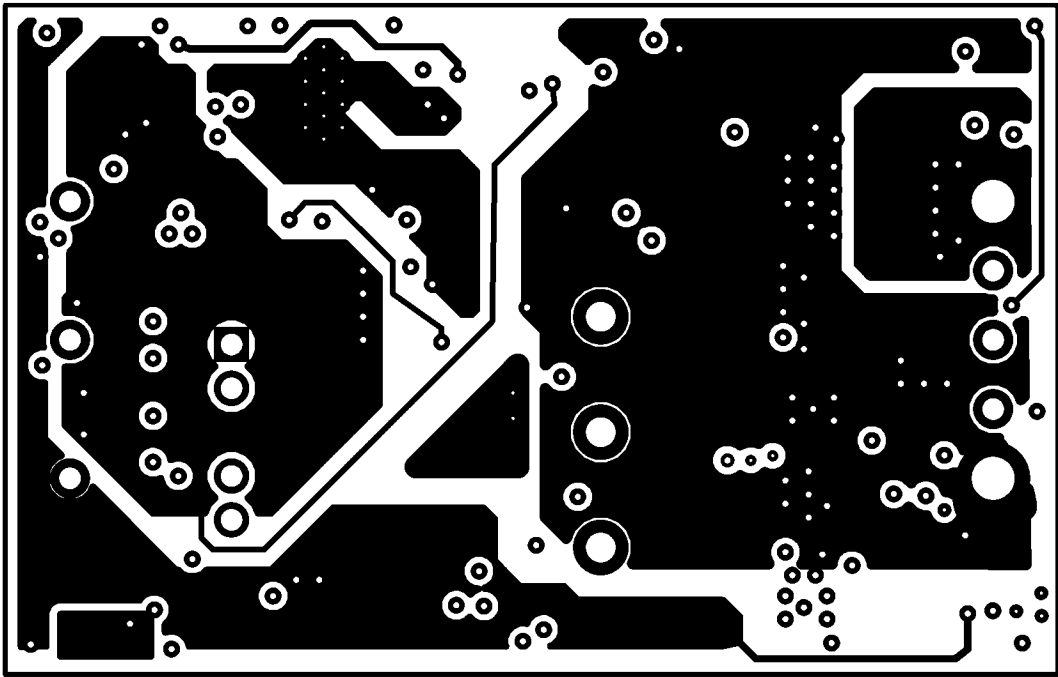

Layer 5

30119516

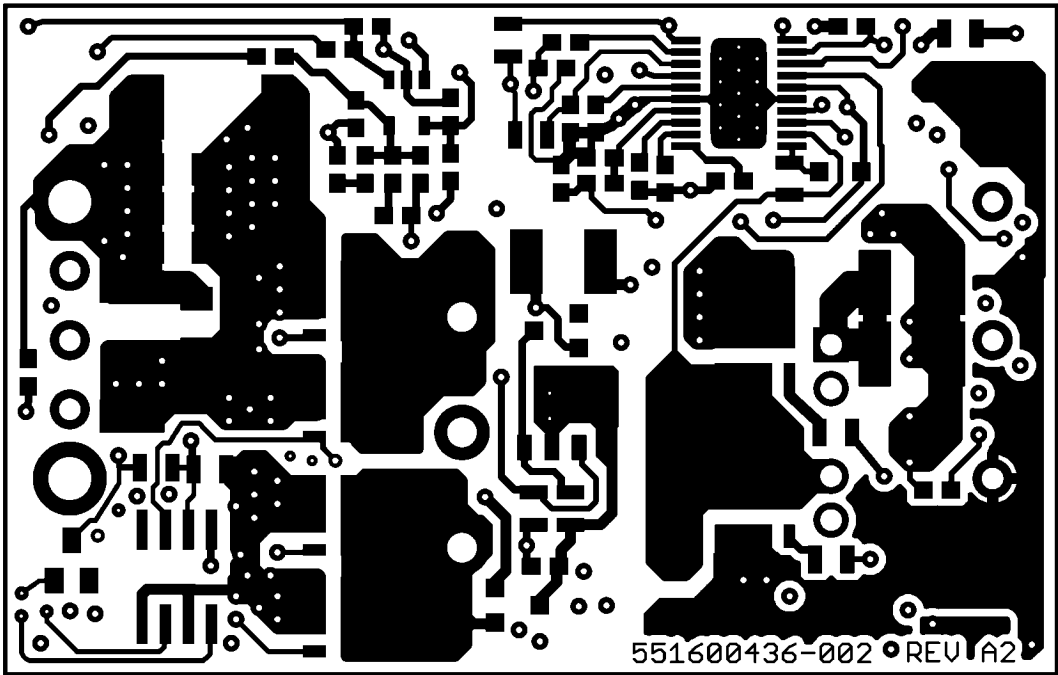

Layer 6

30119517

Notes

AN-2043

Notes

For more National Semiconductor product information and proven design tools, visit the following Web sites at:
www.national.com

Products		Design Support	
Amplifiers	www.national.com/amplifiers	WEBENCH® Tools	www.national.com/webench
Audio	www.national.com/audio	App Notes	www.national.com/appnotes
Clock and Timing	www.national.com/timing	Reference Designs	www.national.com/refdesigns
Data Converters	www.national.com/adc	Samples	www.national.com/samples
Interface	www.national.com/interface	Eval Boards	www.national.com/evalboards
LVDS	www.national.com/lvds	Packaging	www.national.com/packaging
Power Management	www.national.com/power	Green Compliance	www.national.com/quality/green
Switching Regulators	www.national.com/switchers	Distributors	www.national.com/contacts
LDOs	www.national.com/ldo	Quality and Reliability	www.national.com/quality
LED Lighting	www.national.com/led	Feedback/Support	www.national.com/feedback
Voltage References	www.national.com/vref	Design Made Easy	www.national.com/easy
PowerWise® Solutions	www.national.com/powerwise	Applications & Markets	www.national.com/solutions
Serial Digital Interface (SDI)	www.national.com/sdi	Mil/Aero	www.national.com/milaero
Temperature Sensors	www.national.com/tempensors	SolarMagic™	www.national.com/solarmagic
PLL/VCO	www.national.com/wireless	PowerWise® Design University	www.national.com/training

THE CONTENTS OF THIS DOCUMENT ARE PROVIDED IN CONNECTION WITH NATIONAL SEMICONDUCTOR CORPORATION ("NATIONAL") PRODUCTS. NATIONAL MAKES NO REPRESENTATIONS OR WARRANTIES WITH RESPECT TO THE ACCURACY OR COMPLETENESS OF THE CONTENTS OF THIS PUBLICATION AND RESERVES THE RIGHT TO MAKE CHANGES TO SPECIFICATIONS AND PRODUCT DESCRIPTIONS AT ANY TIME WITHOUT NOTICE. NO LICENSE, WHETHER EXPRESS, IMPLIED, ARISING BY ESTOPPEL OR OTHERWISE, TO ANY INTELLECTUAL PROPERTY RIGHTS IS GRANTED BY THIS DOCUMENT.

TESTING AND OTHER QUALITY CONTROLS ARE USED TO THE EXTENT NATIONAL DEEMS NECESSARY TO SUPPORT NATIONAL'S PRODUCT WARRANTY. EXCEPT WHERE MANDATED BY GOVERNMENT REQUIREMENTS, TESTING OF ALL PARAMETERS OF EACH PRODUCT IS NOT NECESSARILY PERFORMED. NATIONAL ASSUMES NO LIABILITY FOR APPLICATIONS ASSISTANCE OR BUYER PRODUCT DESIGN. BUYERS ARE RESPONSIBLE FOR THEIR PRODUCTS AND APPLICATIONS USING NATIONAL COMPONENTS. PRIOR TO USING OR DISTRIBUTING ANY PRODUCTS THAT INCLUDE NATIONAL COMPONENTS, BUYERS SHOULD PROVIDE ADEQUATE DESIGN, TESTING AND OPERATING SAFEGUARDS.

EXCEPT AS PROVIDED IN NATIONAL'S TERMS AND CONDITIONS OF SALE FOR SUCH PRODUCTS, NATIONAL ASSUMES NO LIABILITY WHATSOEVER, AND NATIONAL DISCLAIMS ANY EXPRESS OR IMPLIED WARRANTY RELATING TO THE SALE AND/OR USE OF NATIONAL PRODUCTS INCLUDING LIABILITY OR WARRANTIES RELATING TO FITNESS FOR A PARTICULAR PURPOSE, MERCHANTABILITY, OR INFRINGEMENT OF ANY PATENT, COPYRIGHT OR OTHER INTELLECTUAL PROPERTY RIGHT.

LIFE SUPPORT POLICY

NATIONAL'S PRODUCTS ARE NOT AUTHORIZED FOR USE AS CRITICAL COMPONENTS IN LIFE SUPPORT DEVICES OR SYSTEMS WITHOUT THE EXPRESS PRIOR WRITTEN APPROVAL OF THE CHIEF EXECUTIVE OFFICER AND GENERAL COUNSEL OF NATIONAL SEMICONDUCTOR CORPORATION. As used herein:

Life support devices or systems are devices which (a) are intended for surgical implant into the body, or (b) support or sustain life and whose failure to perform when properly used in accordance with instructions for use provided in the labeling can be reasonably expected to result in a significant injury to the user. A critical component is any component in a life support device or system whose failure to perform can be reasonably expected to cause the failure of the life support device or system or to affect its safety or effectiveness.

National Semiconductor and the National Semiconductor logo are registered trademarks of National Semiconductor Corporation. All other brand or product names may be trademarks or registered trademarks of their respective holders.

Copyright© 2010 National Semiconductor Corporation

For the most current product information visit us at www.national.com



National Semiconductor
Americas Technical
Support Center
Email: support@nsc.com
Tel: 1-800-272-9959

National Semiconductor Europe
Technical Support Center
Email: europe.support@nsc.com

National Semiconductor Asia
Pacific Technical Support Center
Email: ap.support@nsc.com

National Semiconductor Japan
Technical Support Center
Email: jpn.feedback@nsc.com