

LM5060EVAL Evaluation Board

National Semiconductor
Application Note 2000
Frederik Dostal
November 3, 2009



Introduction

The LM5060 evaluation board is designed to demonstrate the capabilities of the LM5060 high side protection controller with low quiescent current. It is intended for evaluation of the functions of the LM5060. One high side N-channel power MOSFET is used. The LM5060 evaluation board schematic is shown in [Figure 6](#). The evaluation board is designed to highlight applications with a small solution size. For more information about LM5060 functional and electrical characteristics, refer to the LM5060 datasheet.

Operating Range

- Maximum Input Voltage, OVP: 37V
- Minimum Input Voltage, UVLO: 9V
- Output Current Range: 0A to 5.0A
- Ambient Temperature Range 0°C to 50°C
- Board Size 1.35in x 2.25in

To aid in the design and evaluation of high-side protection controller solutions based on the LM5060, the evaluation board can be re-configured for different input voltage ranges by modifying the UVLO and the OVP resistive divider (R1, R2, and R3) as well as the protection transient voltage suppressor diode D1.

The load current capability may be increased above 5A of by changing the value of resistor R4. The PCB layout has not been tested for currents above 5A, so this should only be done with some degree of caution.

Typical evaluation board performance and characteristics curves are shown in [Figure 1](#) through [Figure 4](#). The PCB layout is shown in [Figure 8](#) and [Figure 9](#). Test points are provided to enable easy connection and monitoring of critical signals.

Evaluation Board Start-Up

Before applying power to the LM5060 evaluation board, all external connections should be verified. The external power supply must be turned off and connected with proper polarity to the INPUT and GND posts. A load resistor should be connected between the OUTPUT and GND posts as desired. A resistive load will keep the current through Q1 during turn-on relatively low. Electronic load equipment tends to be very low impedance during voltage rise so that the transistor Q1 will see very high currents during turn-on when using such loads. Though resistive loads are suggested for use with the LM5060 evaluation board, electronic loads can be used with caution as well. The output voltage can be monitored with a multi-meter or oscilloscope at the OUTPUT post.

Once all connections to the evaluation board have been verified, input power can be applied. A load resistor or electronic load does not require connection during startup. If the EN test point is pulled high (see the threshold voltage in the electrical characteristics section of the LM5060 datasheet), the output voltage will ramp up when an input voltage is applied.

For the evaluation board to start up, the EN pin needs to be pulled high. A lab cable is required from the EN pin to the VIN pin or other voltage source higher than 2.0V.

Make sure that the external power supply (input voltage power source) is capable of providing enough current to the output load so that the output voltage can be obtained.

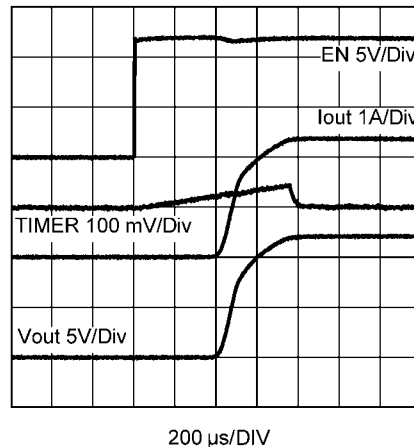

30104712

FIGURE 1. Start-Up Waveforms

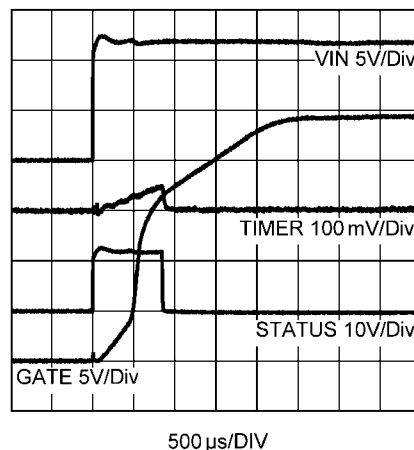

30104713

FIGURE 2. Start-Up Waveforms

Inductive Kick-Back Protection

Diode D1 and capacitor C4 serve as inductive kick protection to limit voltage spikes generated when shutting down high currents through Q1 when turning the power MOSFET off. Capacitor C5 is useful for preventing negative voltages on the OUTPUT trace as the MOSFET Q1 is turned off.

Enable

The EN test point provided on the LM5060 evaluation board is used to control the LM5060 operation. To shut down the LM5060 evaluation board apply a voltage less than 0.8V to

the EN pin, connect to ground, or open the connection. To start up the LM5060 evaluation board apply a voltage greater than 2.0V to the EN connection, or connect to VIN directly. If the EN test point is left open, the EN pin internal pull-down will ensure that the LM5060 remains Off. See the LM5060 datasheet for more details.

Under-Voltage Lock-Out (UVLO)

Resistors R1, R2, and R3 set the Under-Voltage Lock-Out from the scaled down value of the input voltage. The LM5060 evaluation board is set to engage UVLO at an input voltage between typically 8.0V (low threshold) and 8.8V (high threshold). UVLO is activated when the UVLO pin drops below the high threshold. When UVLO is activated (input voltage is low), the LM5060 turns off MOSFET Q1 but the LM5060 is not latched off. As soon as the UVLO voltage is returned to levels above the high threshold, regular operation will resume.

Over-Voltage Protection (OVP)

Resistors R1, R2, and R3 also set the Over-Voltage Protection level from the scaled value of the input voltage. The resistors on the LM5060 evaluation board are selected to engage OVP when the input voltage rises above 37.1V (typical). When OVP is engaged, the LM5060 turns off MOSFET Q1 but the LM5060 is not latched off. As the input voltage reduces below 32.8V (typical), the MOSFET Q1 will turn back on and the output voltage will go up.

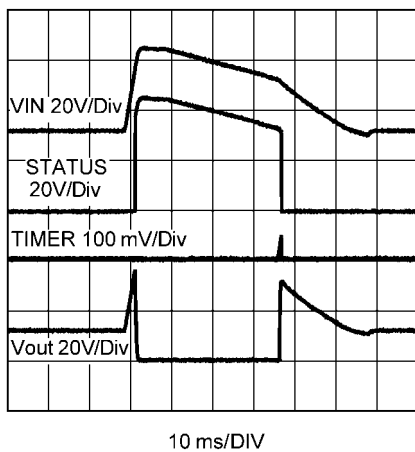

FIGURE 3. OVP Behavior

Over-Current Protection

The 9.09 k Ω resistor on the SENSE pin (R_S), along with the 0.025 Ω of the MOSFET $R_{DS(ON)}$ sets the typical Over-Current threshold (I_{DSTH}) to approximately 5.8A. This may vary from a low of 4.94A to a high of 6.55A depending on variations in the sense current and the V_{DS} comparator offset voltage.

The 0.10 μ F timer capacitor will provide a typical Over-Current fault detection delay time of 18.2 ms. This may vary from a low of 15.4 ms to a high of 23.5 ms depending on variations in the timer charge current and the timer threshold voltage.

Output Status (nPGD)

The output status can be measured at the STATUS connection on the LM5060 evaluation board. The signal will be high when the LM5060 is in a fault condition ($SENSE > OUT$). STATUS will be low when the LM5060 is activated and not in a fault state ($SENSE < OUT$). When the LM5060 is shut down by pulling the EN pin low, the nPGD comparator is shut down and the STATUS signal goes high.

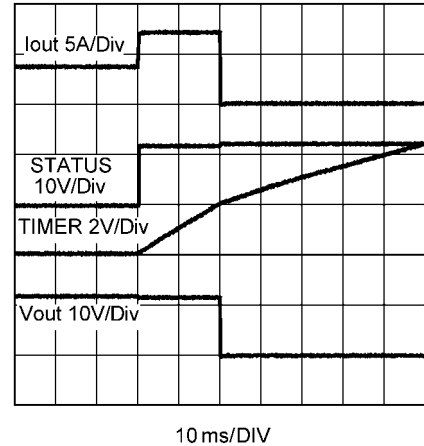

30104715

FIGURE 4. Fault Behavior

Gate Circuitry

C3 is optional and can be used to slow down gate transitions for evaluation.

Timer Setting

The capacitor C1 sets the start-up time delay, transition time delay, and the Over-Current fault detection delay time. If the voltage on the TIMER cap exceeds the 2.0V threshold condition, the LM5060 will latch off the MOSFET Q1 and remain off until either the EN, UVLO or VIN (POR) input is switched low and then high.

The 0.10 μ F (100 nF) timer capacitor will provide a typical start-up delay time of 33.3 ms, a typical transition delay time of 15.5 ms, and a typical Over-Current fault detection delay time of 18.2 ms.

Component Selection

Before changing the default components refer to the LM5060 datasheet for information regarding component selection.

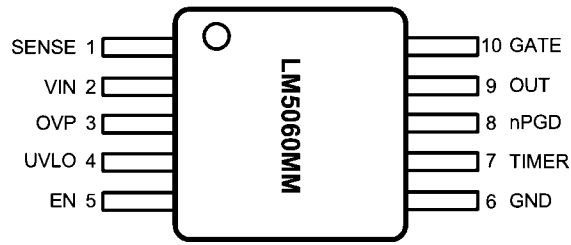

30104703

FIGURE 5. Connection Diagram

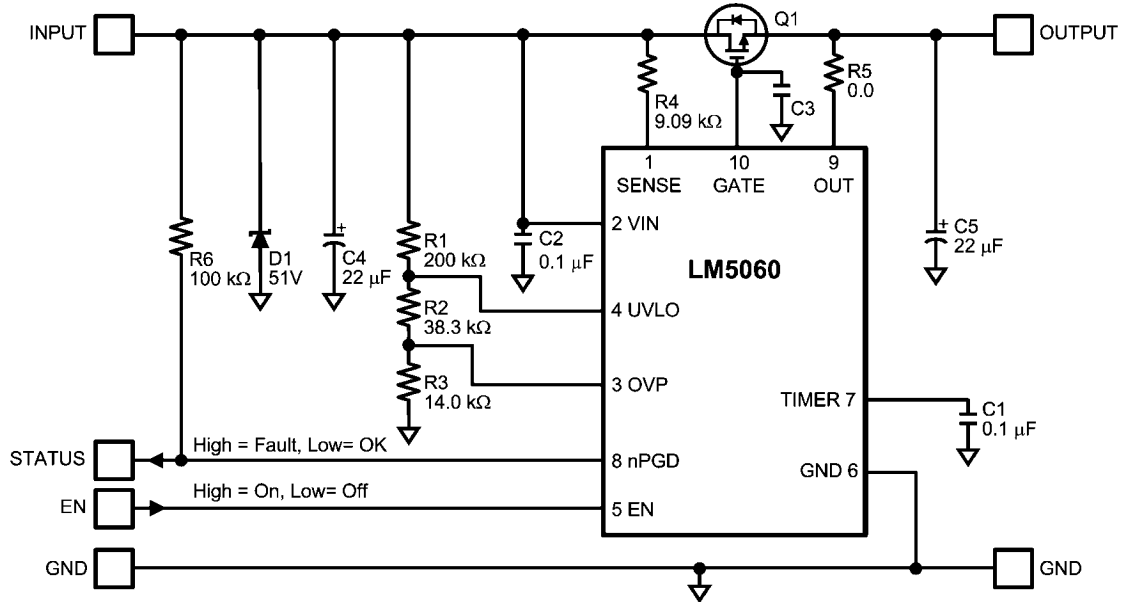

30104704

FIGURE 6. Schematic Diagram

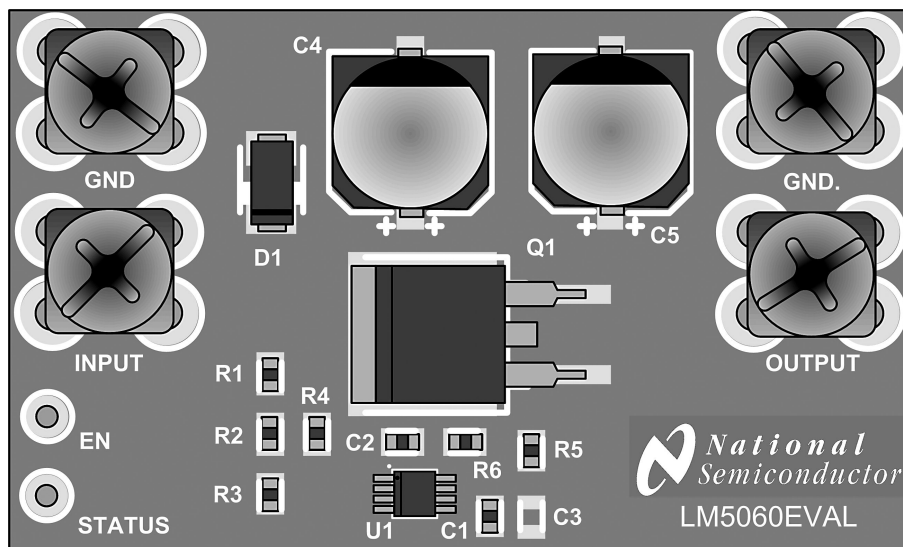

30104707

FIGURE 7. Component Placement

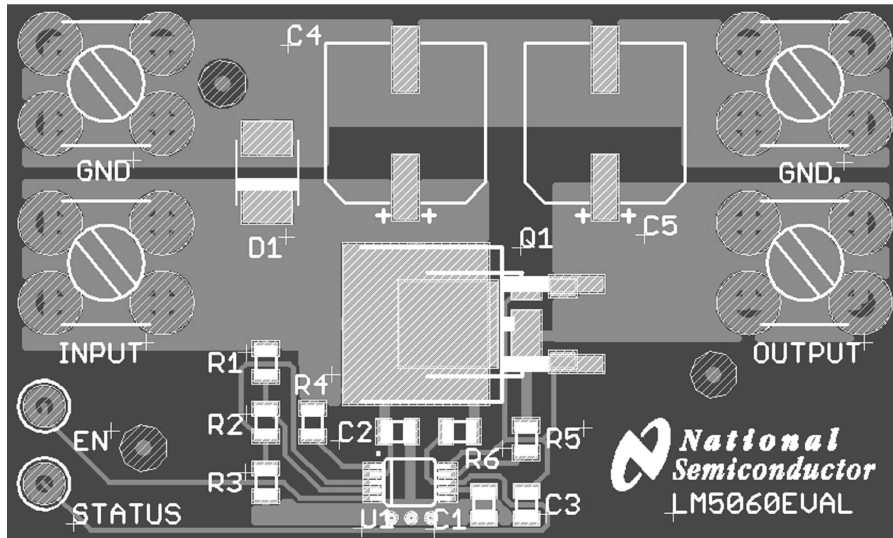

30104705

FIGURE 8. Evaluation Board, Top Side (Component)



30104706

FIGURE 9. Evaluation Board, Bottom Side

Bill of Materials

ID	Description	Manufacturer	Part Number
U1	LM5060Q1MM	National Semiconductor Corporation	LM5060Q1MM
C1	Capacitor: 0.1 μ F; 50V; \pm 10%; X7R; MLCC; 0603	TDK Corporation	C1608X7R1H104K
C2	Capacitor: 0.1 μ F; 100V; \pm 10%; X7R; MLCC; 0805	TDK Corporation	C2012X7R2A104K
C3	(Not Installed)	n/a	n/a
C4	Capacitor: 22 μ F; 100V; Aluminum Electrolytic; SMT	Panasonic - ECG	EEE-HA2A220P
C5			
D1	Diode: TVS; 600W; 51V; SMB	Diodes Inc	SMBJ51A-13-F
Q1	MOSFET: N-Channel; 100V; 40A; 0.025 Ω ; D ² PAK	Vishay/Siliconix	SUM40N10-30-E3
R1	Resistor: 200k Ω ; 0.10W; \pm 5%; Thick Film; 0603	Vishay/Dale	CRCW0603200KJNEA
R2	Resistor: 38.3k Ω ; 0.10W; \pm 1%; Thick Film; 0603	Vishay/Dale	CRCW060338K3FKEA
R3	Resistor: 14.0k Ω ; 0.10W; \pm 1%; Thick Film; 0603	Vishay/Dale	CRCW060314K0FKEA
R4	Resistor: 9.09k Ω ; 0.10W; \pm 1%; Thick Film; 0603	Vishay/Dale	CRCW06039K09FKEA
R5	Resistor: 0.00 Ω ; 0603	Vishay/Dale	CRCW06030000Z0EA
R6	Resistor: 100k Ω ; 0.10W; \pm 1%; Thick Film; 0603	Vishay/Dale	CRCW0603100KFKEA
INPUT	Terminal: 6-32 Screw; Vertical; Snap-In PCB Mount; 15A	Keystone Electronics	7693
OUTPUT			
GND			
GND.			
EN	Test Point Terminal: PCB Miniature; 0.040in Dia Mtg Hole; White	Keystone Electronics	5002
STATUS			

Notes

For more National Semiconductor product information and proven design tools, visit the following Web sites at:

Products		Design Support	
Amplifiers	www.national.com/amplifiers	WEBENCH® Tools	www.national.com/webench
Audio	www.national.com/audio	App Notes	www.national.com/appnotes
Clock and Timing	www.national.com/timing	Reference Designs	www.national.com/refdesigns
Data Converters	www.national.com/adc	Samples	www.national.com/samples
Interface	www.national.com/interface	Eval Boards	www.national.com/evalboards
LVDS	www.national.com/lvds	Packaging	www.national.com/packaging
Power Management	www.national.com/power	Green Compliance	www.national.com/quality/green
Switching Regulators	www.national.com/switchers	Distributors	www.national.com/contacts
LDOs	www.national.com/ldo	Quality and Reliability	www.national.com/quality
LED Lighting	www.national.com/led	Feedback/Support	www.national.com/feedback
Voltage Reference	www.national.com/vref	Design Made Easy	www.national.com/easy
PowerWise® Solutions	www.national.com/powerwise	Solutions	www.national.com/solutions
Serial Digital Interface (SDI)	www.national.com/sdi	Mil/Aero	www.national.com/milaero
Temperature Sensors	www.national.com/tempensors	SolarMagic™	www.national.com/solarmagic
Wireless (PLL/VCO)	www.national.com/wireless	PowerWise® Design University	www.national.com/training

THE CONTENTS OF THIS DOCUMENT ARE PROVIDED IN CONNECTION WITH NATIONAL SEMICONDUCTOR CORPORATION ("NATIONAL") PRODUCTS. NATIONAL MAKES NO REPRESENTATIONS OR WARRANTIES WITH RESPECT TO THE ACCURACY OR COMPLETENESS OF THE CONTENTS OF THIS PUBLICATION AND RESERVES THE RIGHT TO MAKE CHANGES TO SPECIFICATIONS AND PRODUCT DESCRIPTIONS AT ANY TIME WITHOUT NOTICE. NO LICENSE, WHETHER EXPRESS, IMPLIED, ARISING BY ESTOPPEL OR OTHERWISE, TO ANY INTELLECTUAL PROPERTY RIGHTS IS GRANTED BY THIS DOCUMENT.

TESTING AND OTHER QUALITY CONTROLS ARE USED TO THE EXTENT NATIONAL DEEMS NECESSARY TO SUPPORT NATIONAL'S PRODUCT WARRANTY. EXCEPT WHERE MANDATED BY GOVERNMENT REQUIREMENTS, TESTING OF ALL PARAMETERS OF EACH PRODUCT IS NOT NECESSARILY PERFORMED. NATIONAL ASSUMES NO LIABILITY FOR APPLICATIONS ASSISTANCE OR BUYER PRODUCT DESIGN. BUYERS ARE RESPONSIBLE FOR THEIR PRODUCTS AND APPLICATIONS USING NATIONAL COMPONENTS. PRIOR TO USING OR DISTRIBUTING ANY PRODUCTS THAT INCLUDE NATIONAL COMPONENTS, BUYERS SHOULD PROVIDE ADEQUATE DESIGN, TESTING AND OPERATING SAFEGUARDS.

EXCEPT AS PROVIDED IN NATIONAL'S TERMS AND CONDITIONS OF SALE FOR SUCH PRODUCTS, NATIONAL ASSUMES NO LIABILITY WHATSOEVER, AND NATIONAL DISCLAIMS ANY EXPRESS OR IMPLIED WARRANTY RELATING TO THE SALE AND/OR USE OF NATIONAL PRODUCTS INCLUDING LIABILITY OR WARRANTIES RELATING TO FITNESS FOR A PARTICULAR PURPOSE, MERCHANTABILITY, OR INFRINGEMENT OF ANY PATENT, COPYRIGHT OR OTHER INTELLECTUAL PROPERTY RIGHT.

LIFE SUPPORT POLICY

NATIONAL'S PRODUCTS ARE NOT AUTHORIZED FOR USE AS CRITICAL COMPONENTS IN LIFE SUPPORT DEVICES OR SYSTEMS WITHOUT THE EXPRESS PRIOR WRITTEN APPROVAL OF THE CHIEF EXECUTIVE OFFICER AND GENERAL COUNSEL OF NATIONAL SEMICONDUCTOR CORPORATION. As used herein:

Life support devices or systems are devices which (a) are intended for surgical implant into the body, or (b) support or sustain life and whose failure to perform when properly used in accordance with instructions for use provided in the labeling can be reasonably expected to result in a significant injury to the user. A critical component is any component in a life support device or system whose failure to perform can be reasonably expected to cause the failure of the life support device or system or to affect its safety or effectiveness.

National Semiconductor and the National Semiconductor logo are registered trademarks of National Semiconductor Corporation. All other brand or product names may be trademarks or registered trademarks of their respective holders.

Copyright© 2009 National Semiconductor Corporation

For the most current product information visit us at www.national.com



National Semiconductor
Americas Technical
Support Center
Email: support@nsc.com
Tel: 1-800-272-9959

National Semiconductor Europe
Technical Support Center
Email: europe.support@nsc.com

National Semiconductor Asia
Pacific Technical Support Center
Email: ap.support@nsc.com

National Semiconductor Japan
Technical Support Center
Email: jpn.feedback@nsc.com