

20 W + 20 W dual BTL class-D audio amplifier

Features

- 20 W + 20 W continuous output power:
 $R_L = 8 \Omega$, THD = 10% at $V_{CC} = 18 \text{ V}$
- Wide range single supply operation (5 V - 18 V)
- High efficiency ($\eta = 90\%$)
- Four selectable, fixed gain settings of nominally 20 dB, 26 dB, 30 dB and 32 dB
- Differential inputs minimize common-mode noise
- Filterless operation
- No 'pop' at turn-on/off
- Standby and mute features
- Short-circuit protection
- Thermal overload protection
- Externally synchronizable

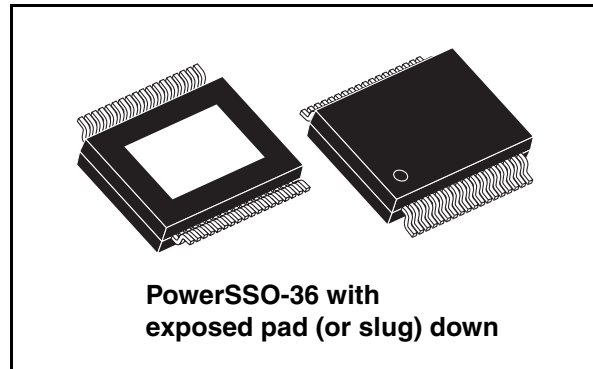

Description

The TDA7491HV is a dual BTL class-D audio amplifier with single power supply designed for LCD TVs and monitors.

Thanks to the high efficiency and a slug-down package no heatsink is required.

Furthermore, the filterless operation allows a reduction in the external component count.

The TDA7491HV is pin to pin compatible with the TDA7491P and TDA7491LP.

Table 1. Device summary

Order code	Operating Temp. range	Package	Packing
TDA7491HV	0° to 70° C	PowerSSO-36 (slug down)	Tube
TDA7491HV13TR	0° to 70° C	PowerSSO-36 (slug down)	Tape and reel

Contents

1	Device block diagram	4
2	Pin description	5
2.1	Pin out	5
2.2	Pin list	6
3	Electrical specifications	7
3.1	Absolute maximum ratings	7
3.2	Thermal data	7
3.3	Electrical specifications	7
4	Characterization curves	9
4.1	With 4 Ω load at $V_s = 14$ V	9
4.2	With 6 Ω load at $V_s = 16$ V	14
4.3	With 8 Ω load at $V_s = 18$ V	20
5	Package information	27
6	Application circuit	29
7	Application information	30
7.1	Mode selection	30
7.2	Gain setting	31
7.3	Input resistance and capacitance	31
7.4	Internal and external clocks	32
7.4.1	Master mode (internal clock)	32
7.4.2	Slave mode (external clock)	32
7.5	Filterless modulation	33
7.6	Output low-pass filter	34
7.7	Protection function	35
7.8	Diagnostic output	35
7.9	Heatsink requirements	36

8 **Revision history** **37**

1 Device block diagram

Figure 1 shows the block diagram of one of the two identical channels of the TDA7491HV.

Figure 1. Internal block diagram (one channel only)

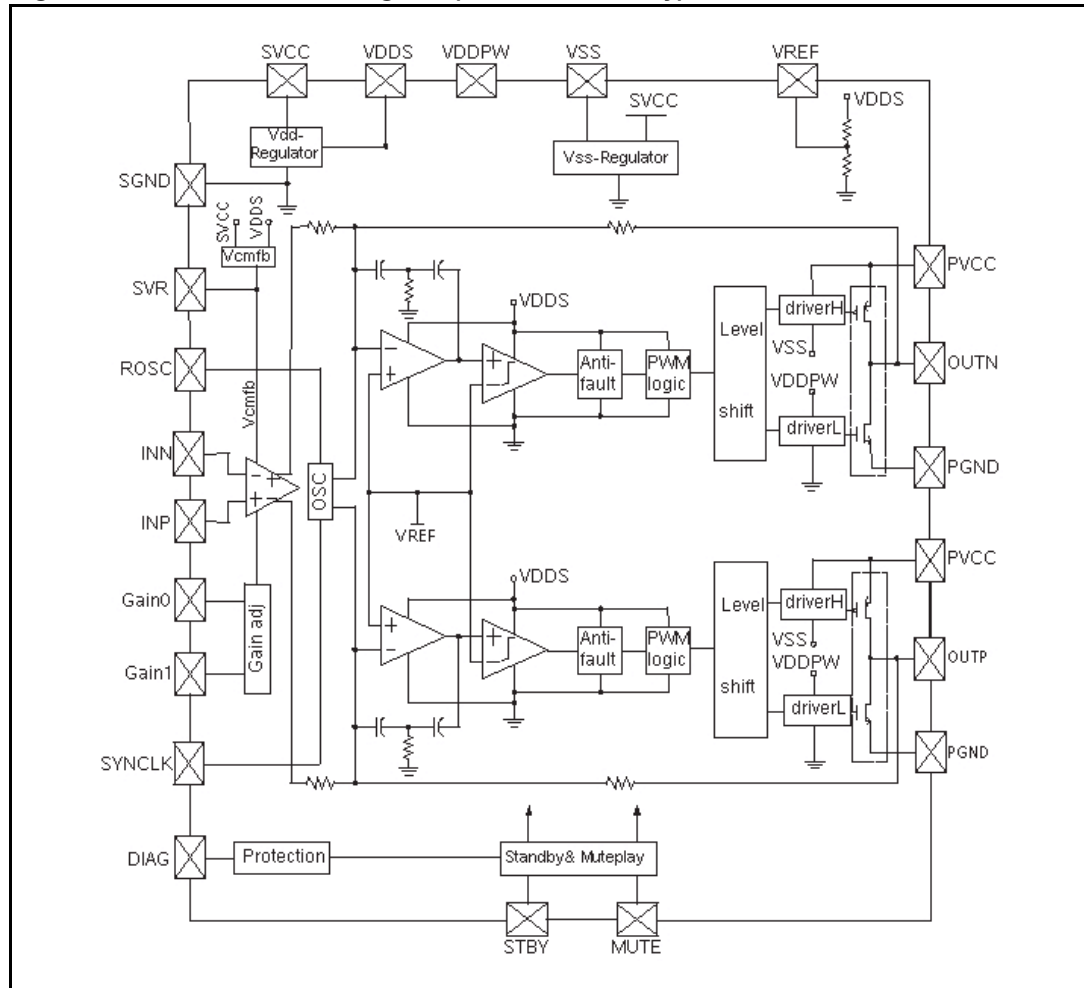

2 Pin description

2.1 Pin out

Figure 2. Pin connection (top view, PCB view)

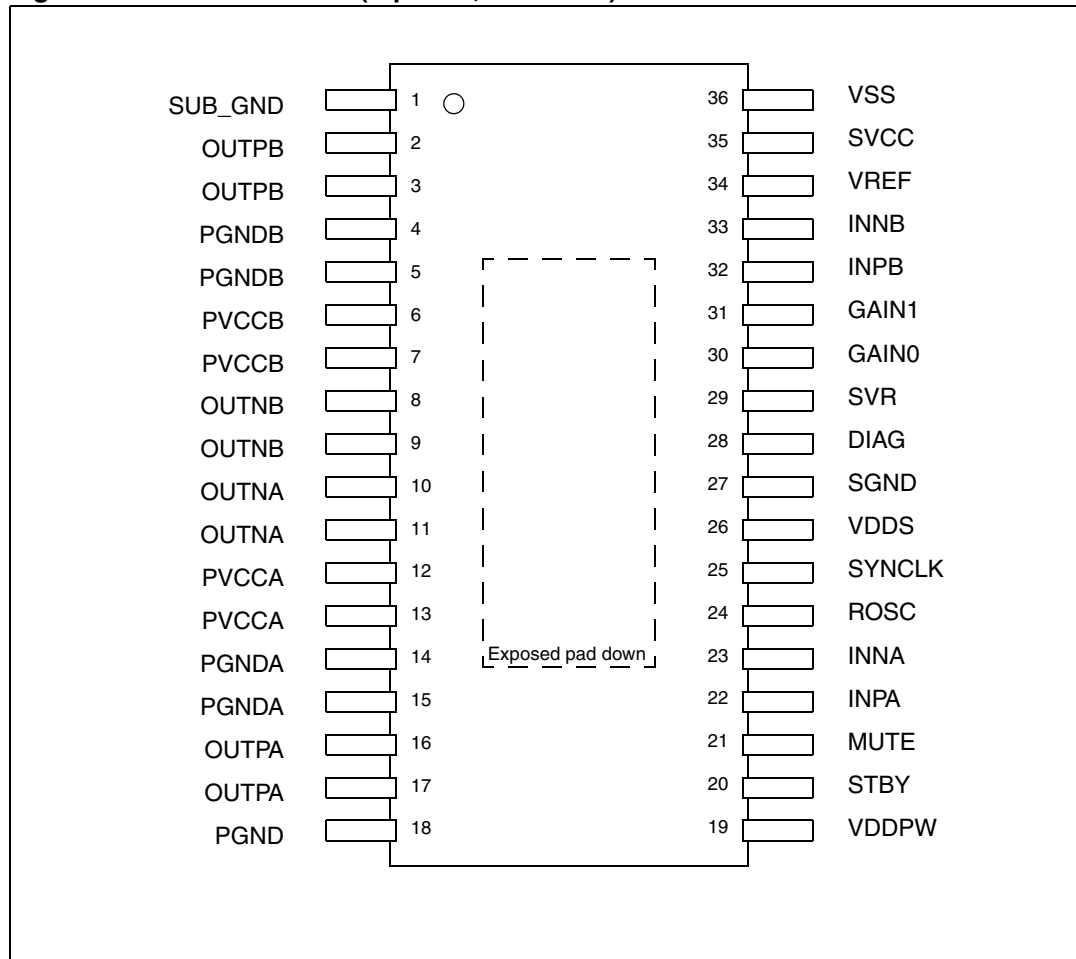

2.2 Pin list

Table 2. Pin description list

Number	Name	Type	Description
1	SUB_GND	POWER	Connect to the frame
2,3	OUTPB	OUT	Positive PWM for right channel
4,5	PGNDB	POWER	Power stage round for right channel
6,7	PVCCB	POWER	Power supply for right channel
8,9	OUTNB	OUT	Negative PWM output for right channel
10,11	OUTNA	OUT	Negative PWM output for right channel
12,13	PVCCA	POWER	Power supply for left channel
14,15	PGNDA	POWER	Power stage round for left channel
16,17	OUTPA	OUT	Positive PWM output for left channel
18	PGND	POWER	Power stage round
19	VDDPW	OUT	3.3 V (nominal) regulator output referred to ground for power stage
20	STBY	INPUT	Standby mode control
21	MUTE	INPUT	Mute mode control
22	INPA	INPUT	Positive differential input of left channel
23	INNA	INPUT	Negative differential input of left channel
24	ROSC	OUT	Master oscillator frequency-setting pin
25	SYNCLCK	IN/OUT	Clock in/out for external oscillator
26	VDDS	OUT	3.3 V (nominal) regulator output referred to ground for signal blocks
27	SGND	POWER	Signal round
28	DIAG	OUT	Open-drain diagnostic output
29	SVR	OUT	Supply voltage rejection
30	GAIN0	INPUT	Gain setting input 1
31	GAIN1	INPUT	Gain setting input 2
32	INPB	INPUT	Positive differential input of right channel
33	INNB	INPUT	Negative differential input of right channel
34	VREF	OUT	Half VDDS (nominal) referred to ground
35	SVCC	POWER	Signal power supply
36	VSS	OUT	3.3 V (nominal) regulator output referred to power supply

3 Electrical specifications

3.1 Absolute maximum ratings

Table 3. Absolute maximum ratings

Symbol	Parameter	Value	Unit
VCC	DC supply voltage for pins PVCCA, PVCCB, SVCC	23	V
T _{op}	Operating temperature	0 to 70	°C
T _j	Junction temperature	-40 to 150	°C
T _{stg}	Storage temperature	-40 to 150	°C

3.2 Thermal data

Table 4. Thermal data

Symbol	Parameter	Min	Typ	Max	Unit
R _{th j-case}	Thermal resistance, junction to case		2	3	°C/W
R _{th j-amb}	Thermal resistance, junction to ambient (mounted on recommended PCB) ⁽¹⁾		24		

1. FR4 with vias to copper area of 9 cm² (see also [Section 7.9: Heatsink requirements on page 36](#)).

3.3 Electrical specifications

Unless otherwise stated, the results in [Table 5](#) below are given for the conditions: VCC = 18 V, R_L (load) = 8 Ω, R_{OSC} = 39 kΩ, C1 = 100 nF, f = 1 kHz, G_V = 20 dB, and Tamb = 25° C.

Table 5. Electrical specifications

Symbol	Parameter	Condition	Min	Typ	Max	Unit
VCC	Supply voltage for pins PVCCA, PVCCB, SVCC		5		18	V
I _q	Total quiescent			26	35	mA
I _{qSTBY}	Quiescent current in standby			2.5	5.0	μA
V _{OS}	Output offset voltage	Play mode	-150		150	mV
V _{OS}	Output offset voltage	Mute mode	-150		150	mV
I _{OC}	Over current protection threshold	R _L = 0 Ω	3	5		A
T _j	Junction temperature at thermal shut-down			150		°C
R _i	Input resistance	Differential input	55	60		kΩ
V _{OV}	Over voltage protection threshold		19	21		

Table 5. Electrical specifications (continued)

Symbol	Parameter	Condition	Min	Typ	Max	Unit
R _{dsON}	Power transistor on resistance	High side		0.2		Ω
		Low side		0.2		
P _o	Output power	THD = 10%		20		W
		THD = 1%		16		
P _o	Output power	R _L = 8 Ω, THD = 10%		9.5		W
		R _L = 8 Ω, THD = 1% VCC = 12 V		7.2		
P _D	Dissipated power	P _o = 20 W + 20 W, THD = 10%		4.0		W
η	Efficiency	P _o = 20 W + 20 W	80	90		%
THD	Total harmonic distortion	P _o = 1 W		0.1	0.4	%
G _V	Closed loop gain	GAIN0 = L, GAIN1 = L	18	20	22	dB
		GAIN0 = L, GAIN1 = H	24	26	28	
		GAIN0 = H, GAIN1 = L	28	30	32	
		GAIN0 = H, GAIN1 = H	30	32	34	
ΔG _V	Gain matching		-1		1	dB
CT	Cross talk	f = 1 kHz		50		dB
eN	Total input noise	A Curve, G _V = 20 dB		20		μV
		f = 22 Hz to 22 kHz		25	35	
SVRR	Supply voltage rejection ratio	f _r = 100 Hz, V _r = 0.5 V, C _{SVR} = 10 μF	40	50		dB
T _r , T _f	Rise and fall times			50		ns
f _{SW}	Switching frequency	Internal oscillator	290	310	330	kHz
f _{SWR}	Output switching frequency	With internal oscillator ⁽¹⁾	250			kHz
		With external oscillator ⁽²⁾	250			
V _{inH}	Digital input high (H)		2.3			V
V _{inL}	Digital input low (L)				0.8	
Function mode	Standby, mute and play modes	STBY < 0.5 V, MUTE = X	Standby			
		STBY > 2.5 V, MUTE < 1 V	Mute			
		STBY > 2.5 V, MUTE > 2 V	Play			
A _{MUTE}	Mute attenuation	VMute = 1 V	60	80		dB

1. f_{SW} = 10⁶ / (64 * R_{OSC} + 440) kHz, f_{SYNCLK} = 2 * f_{SW} with R1 = 3 kΩ (see [Figure 50](#)).

2. f_{SW} = f_{SYNCLK} / 2 with the frequency of the external oscillator.

4 Characterization curves

The following characterization curves were made using the SZ-LAB-TDA7492P demo board. The LC filter for the 4 Ω load used 15 μH and 470 nF components, whilst that for the 6 Ω load used 22 μH and 220 nF and that for the 8 Ω load used 33 μH and 220 nF.

All other test conditions are given along side the corresponding curves.

4.1 With 4 Ω load at Vs = 14 V

Figure 3. Output power vs supply voltage

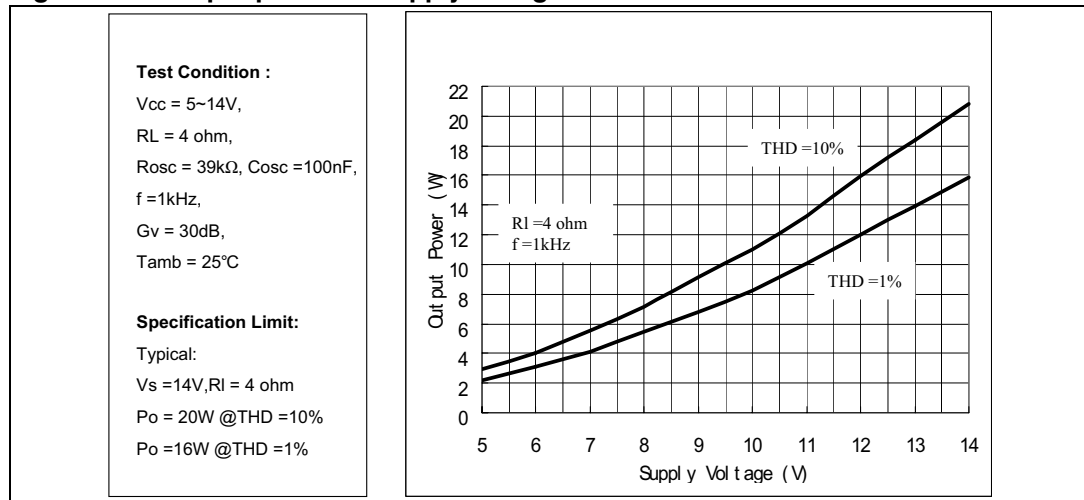

Figure 4. THD vs output power (1 kHz)

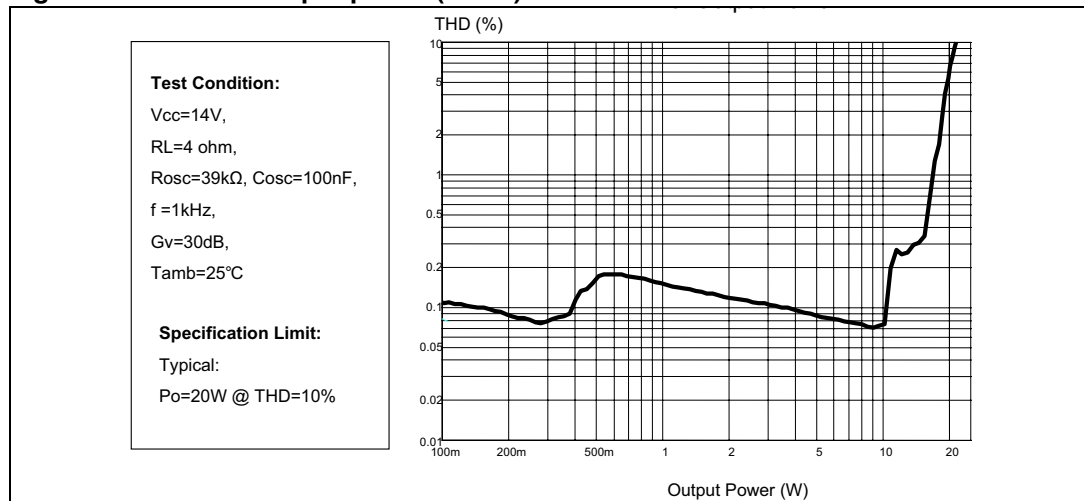

Figure 5. THD vs output power (100 Hz)

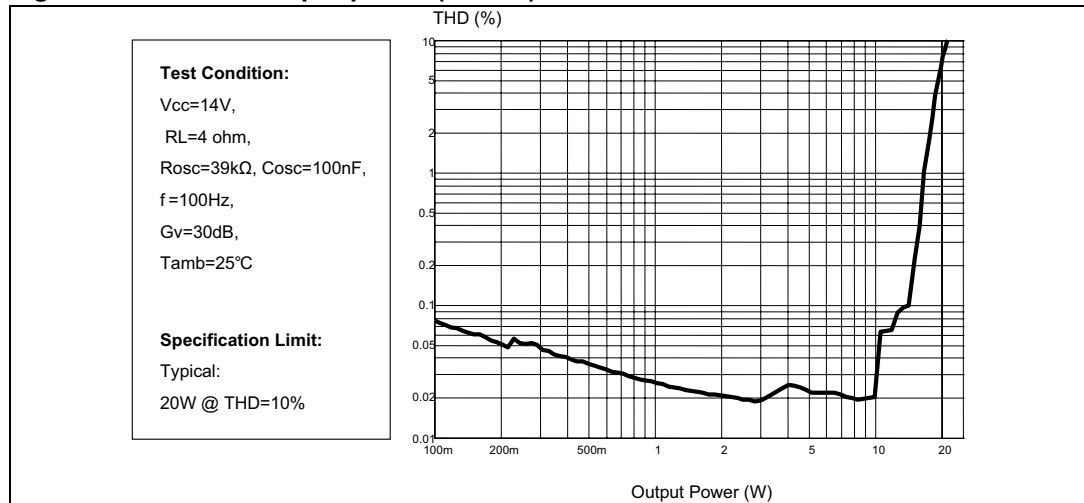

Figure 6. THD vs frequency

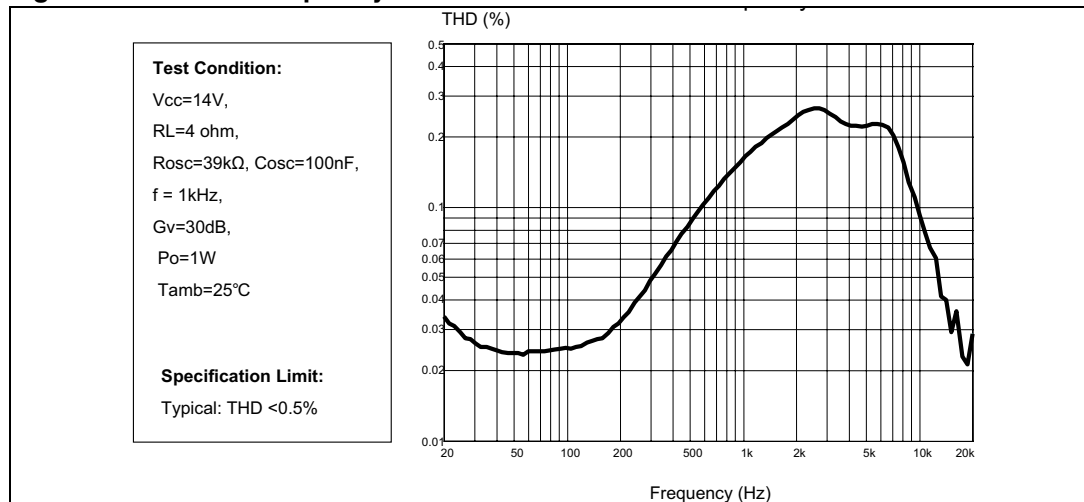

Figure 7. Frequency response

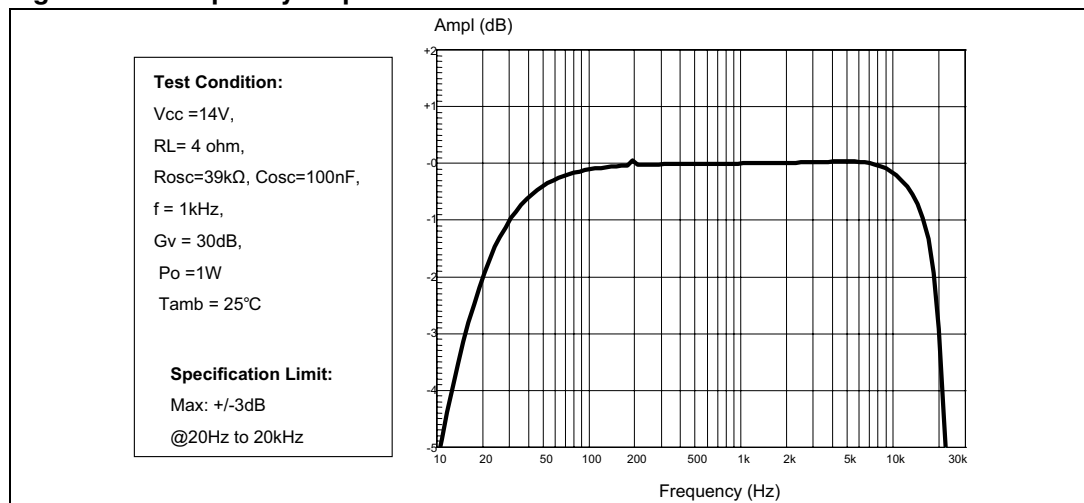

Figure 8. Crosstalk vs frequency

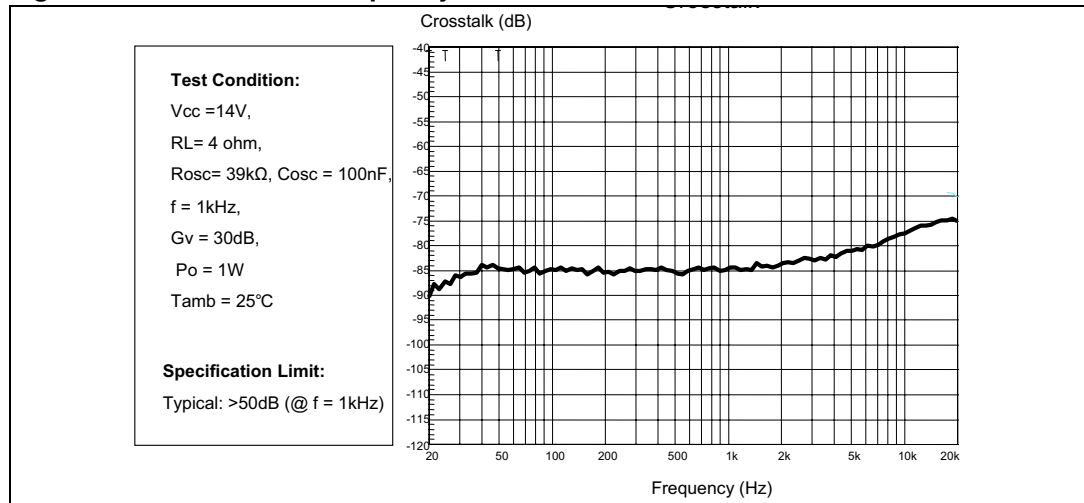

Figure 9. FFT (0 dB)

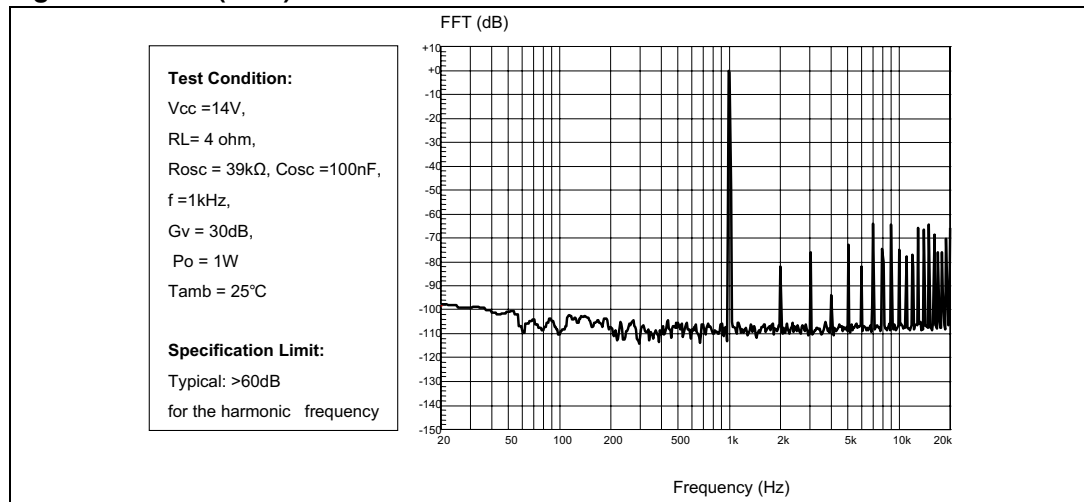

Figure 10. FFT (-60 dB)

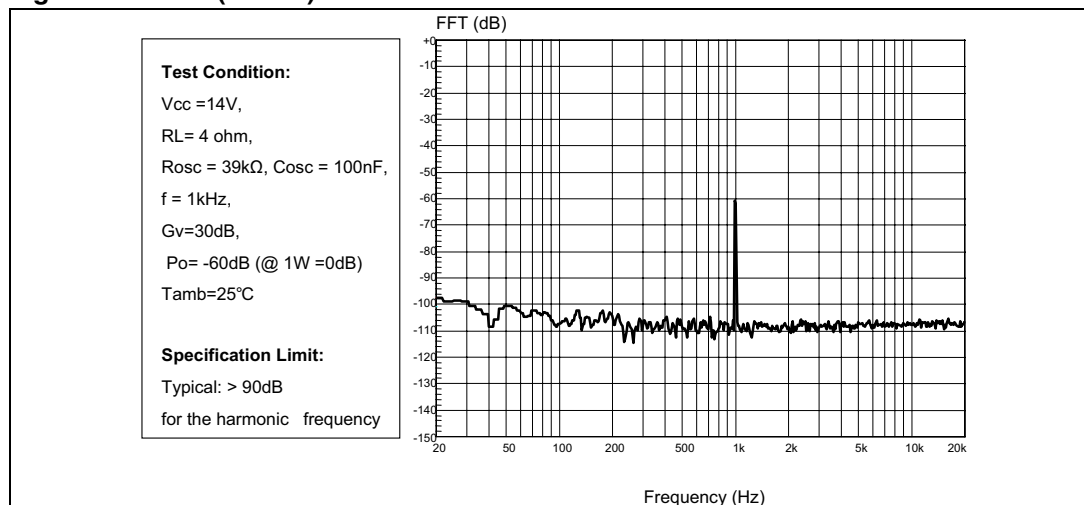

Figure 11. Power supply rejection ratio vs frequency

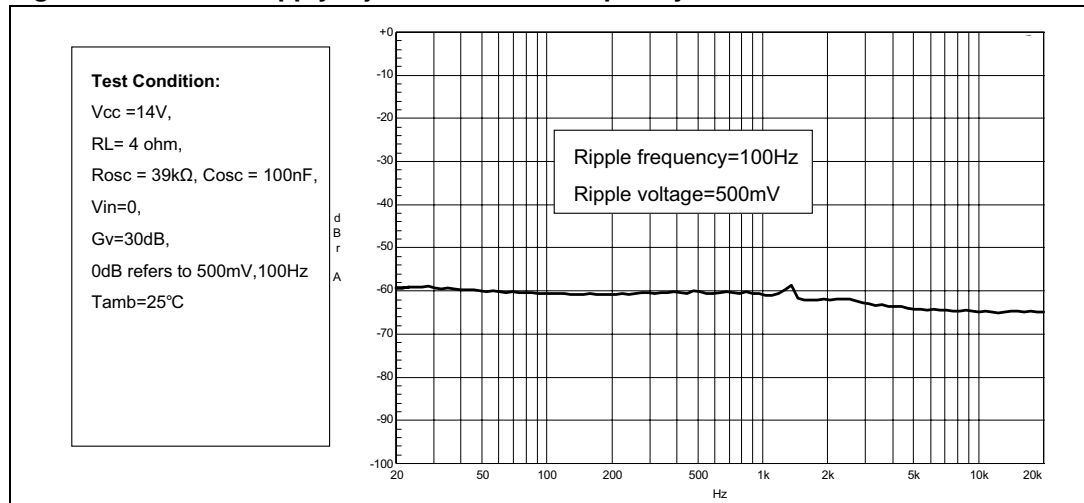

Figure 12. Power dissipation and efficiency vs output power

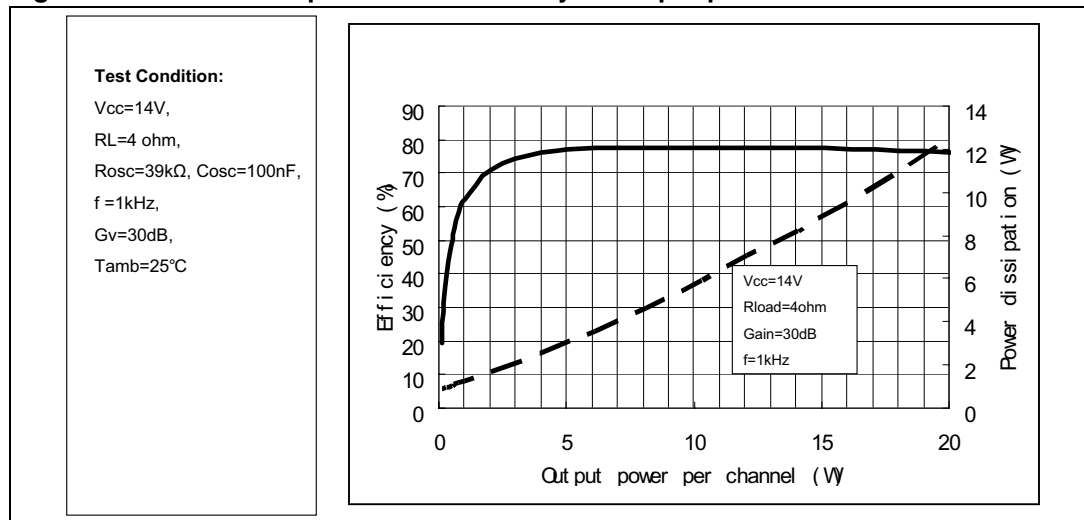

Figure 13. Closed-loop gain vs frequency

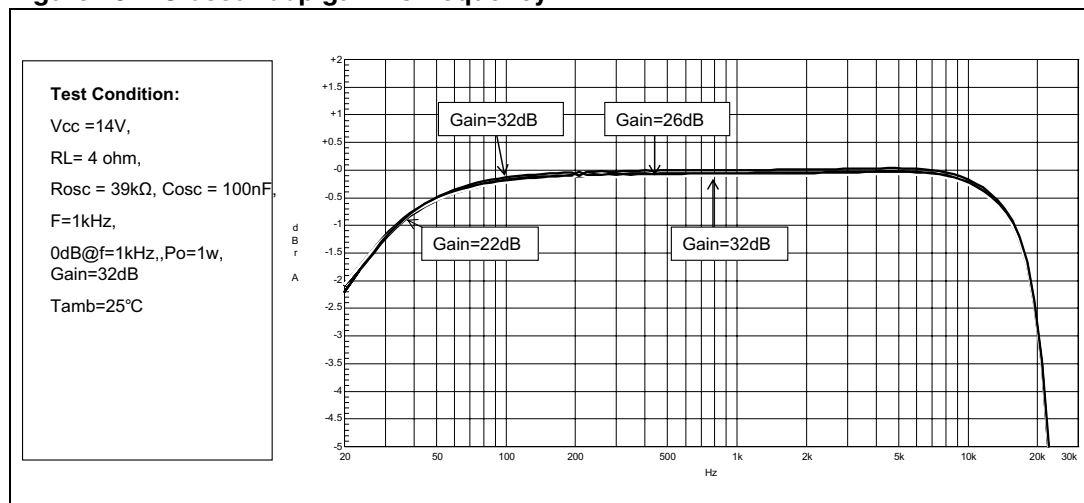

Figure 14. Current consumption vs voltage on pin MUTE

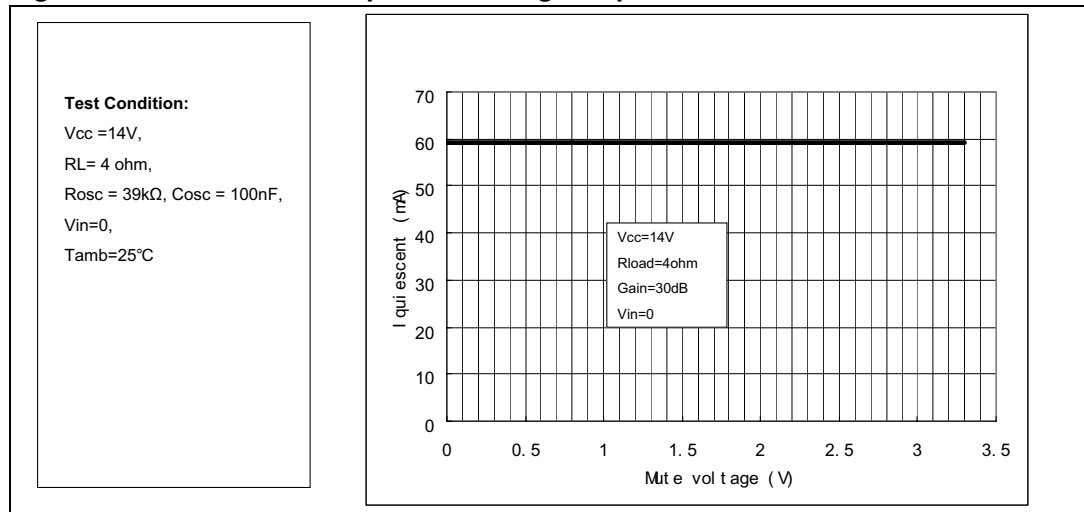

Figure 15. Attenuation vs voltage on pin MUTE

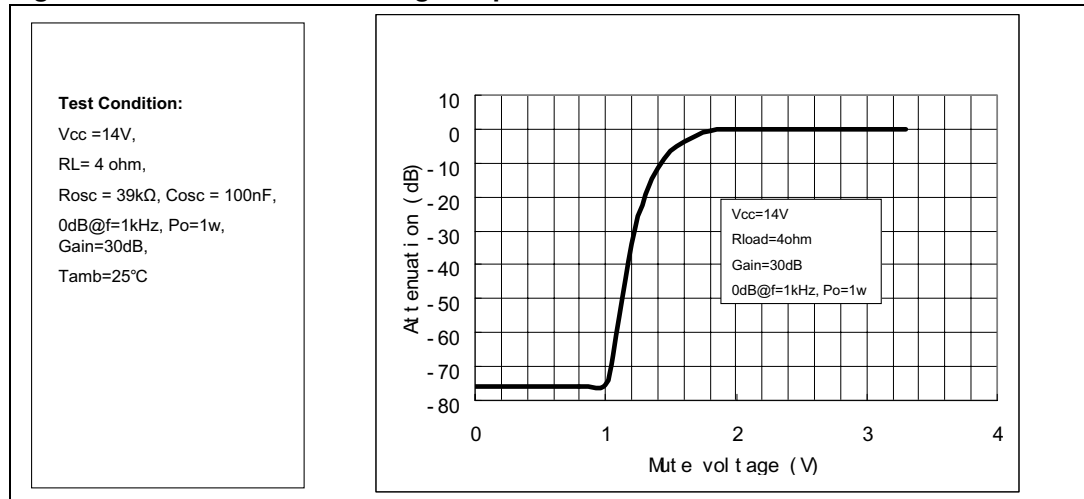

Figure 16. Current consumption vs voltage on pin STBY

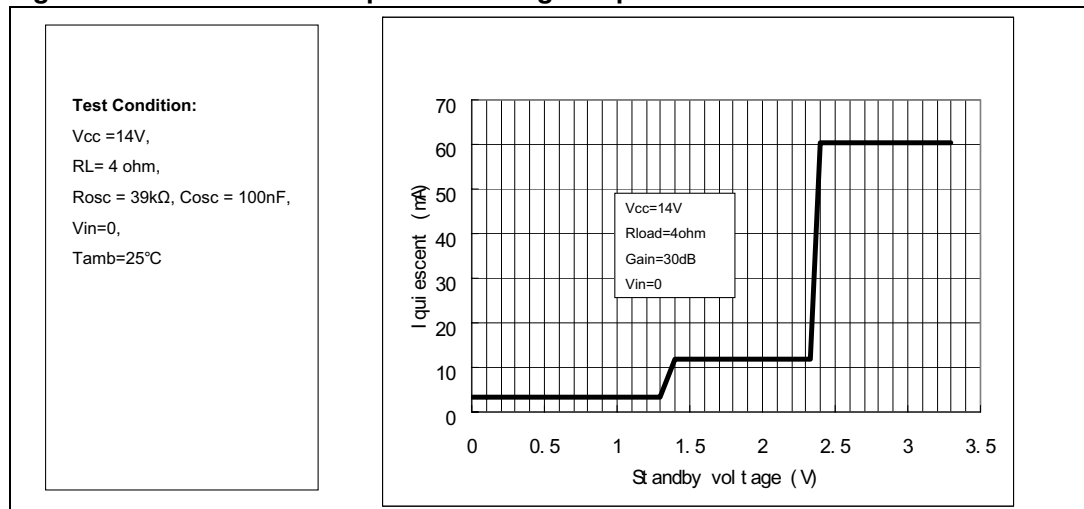
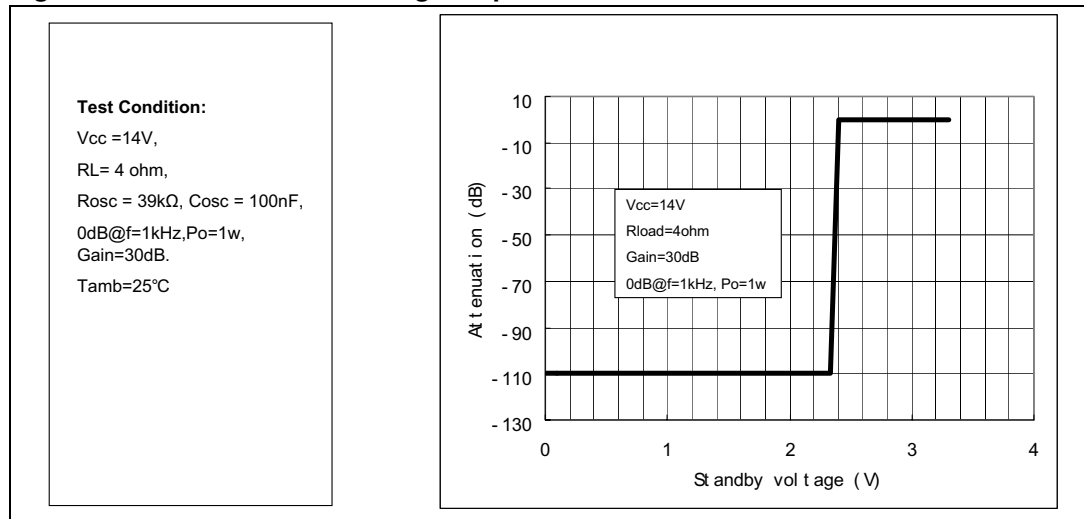

Figure 17. Attenuation vs voltage on pin STBY



4.2 With 6 Ω load at Vs = 16 V

Figure 18. Output power vs supply voltage

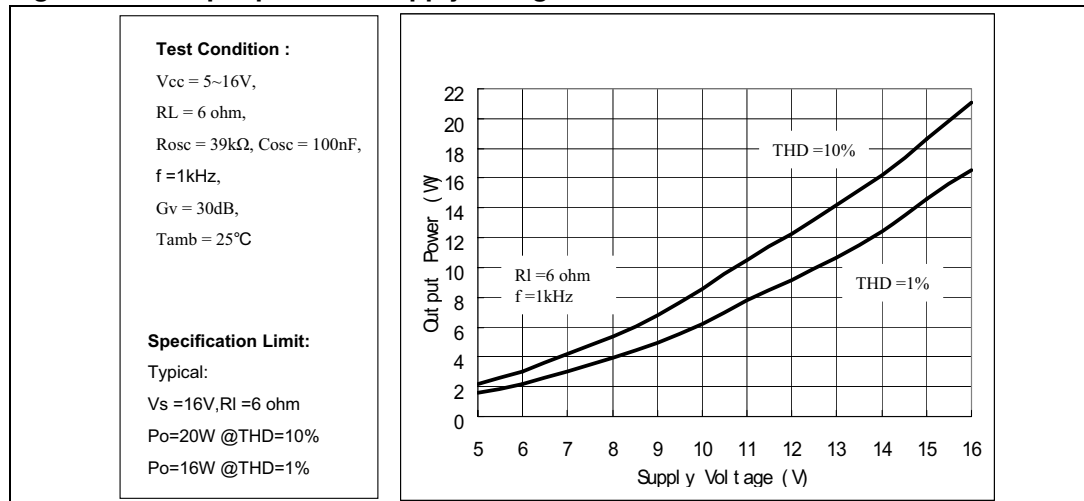

Figure 19. THD vs output power (1 kHz)

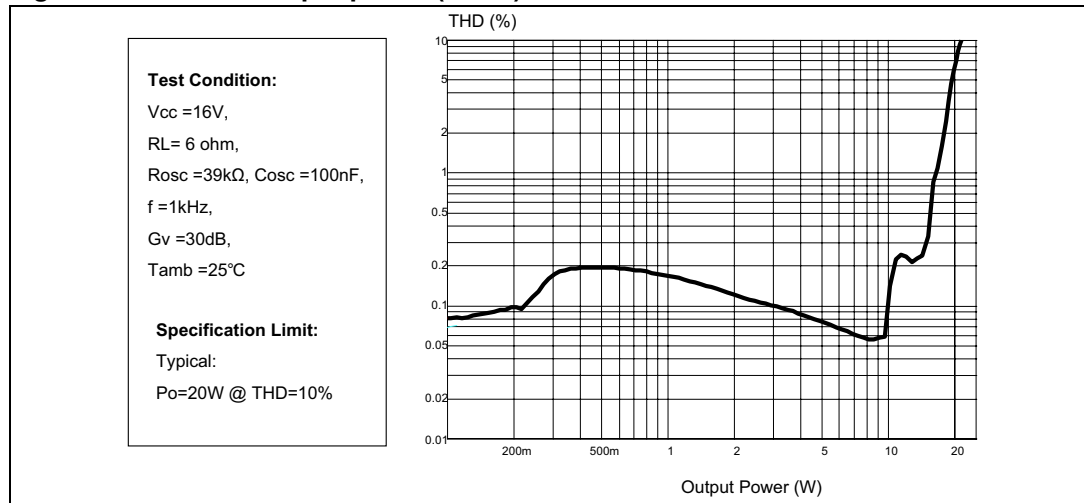

Figure 20. THD vs output power (100 Hz)

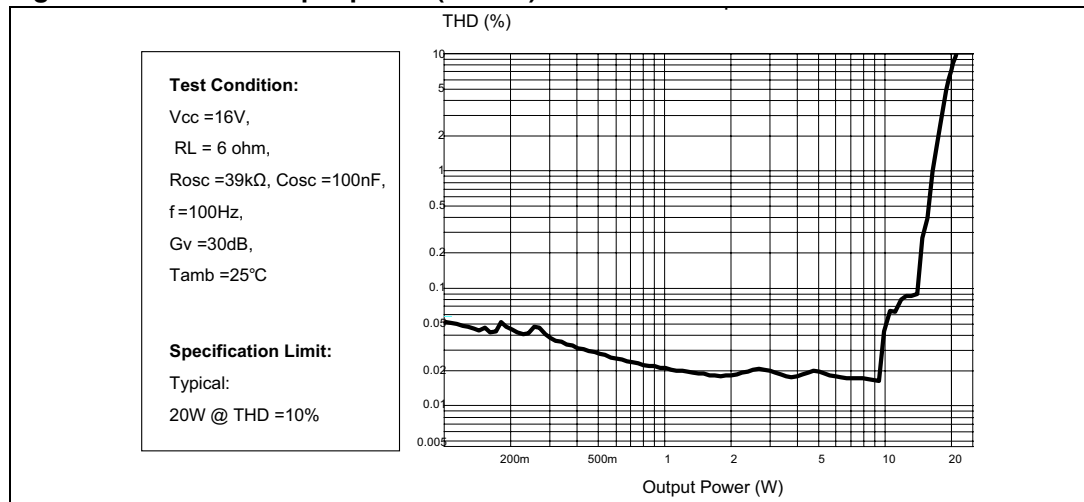

Figure 21. THD vs frequency

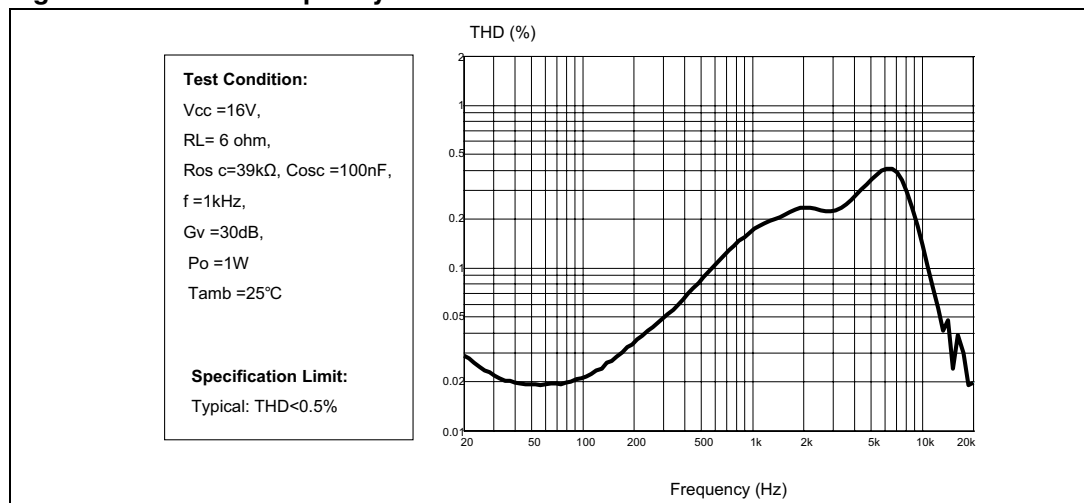

Figure 22. Frequency response

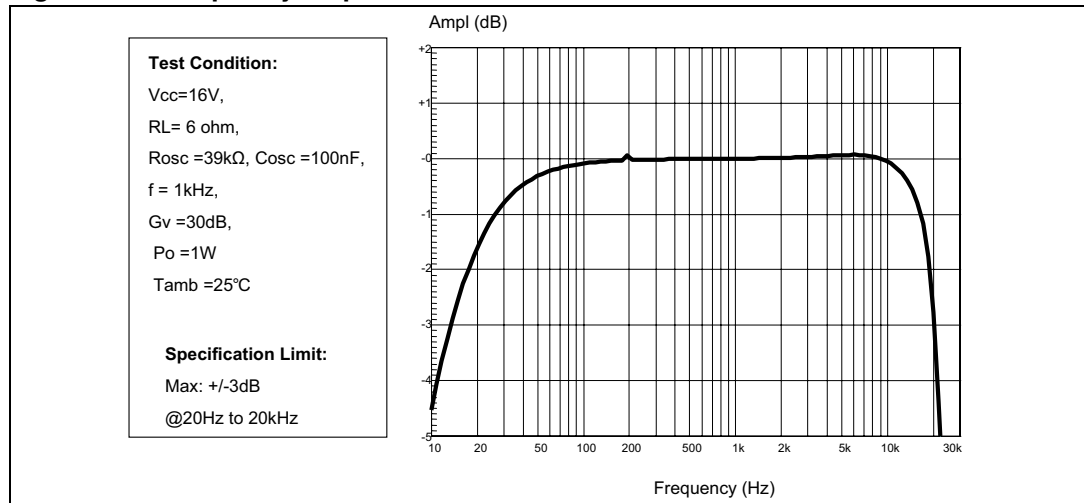

Figure 23. Crosstalk vs frequency

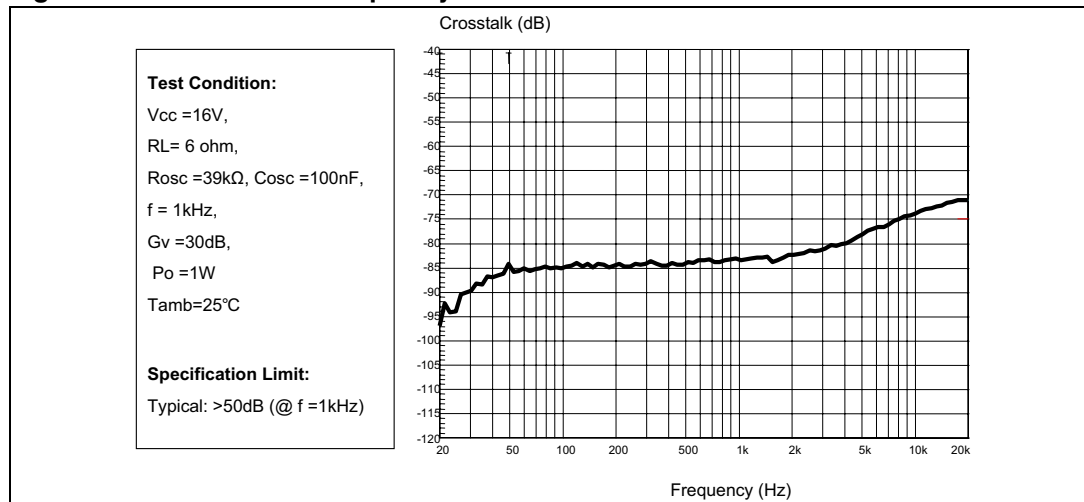

Figure 24. FFT (0 dB)

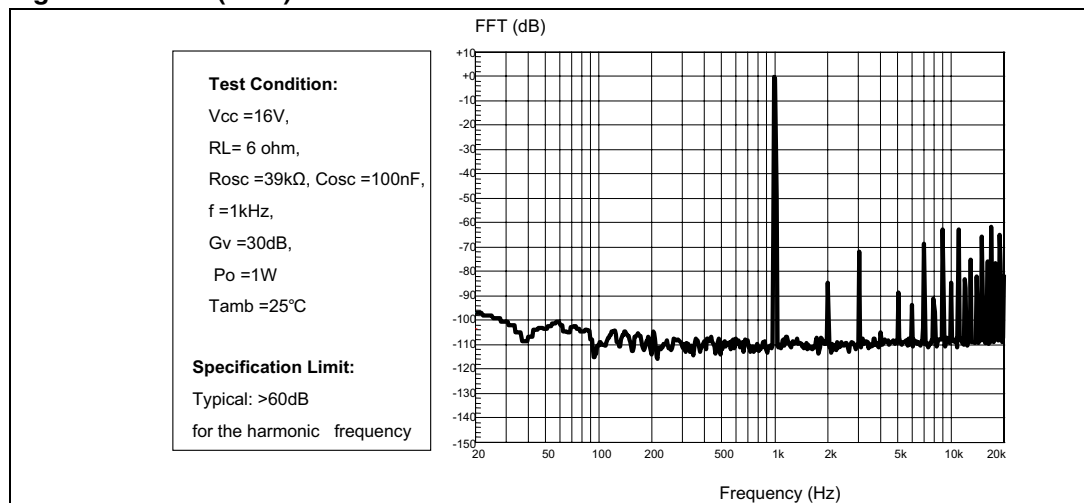

Figure 25. FFT (-60 dB)

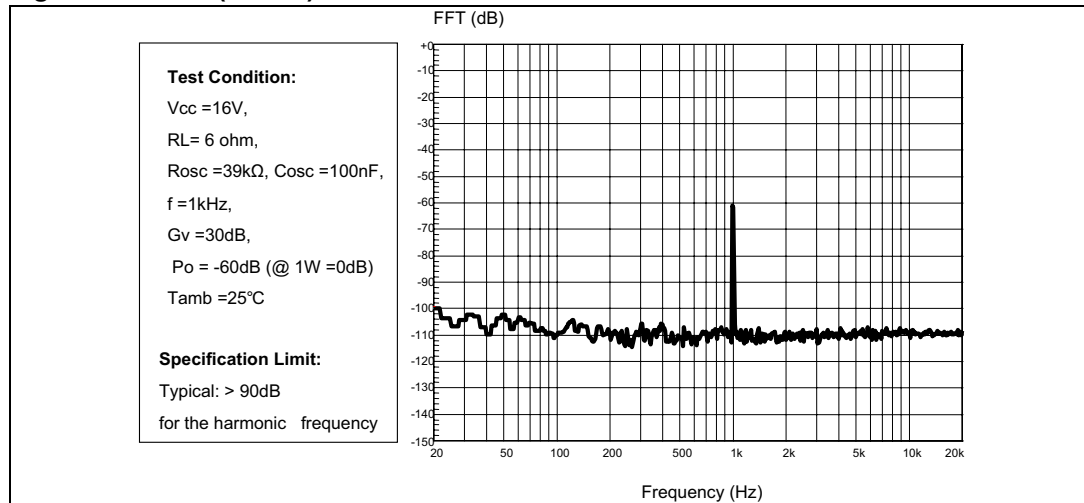

Figure 26. Power supply rejection ratio vs frequency

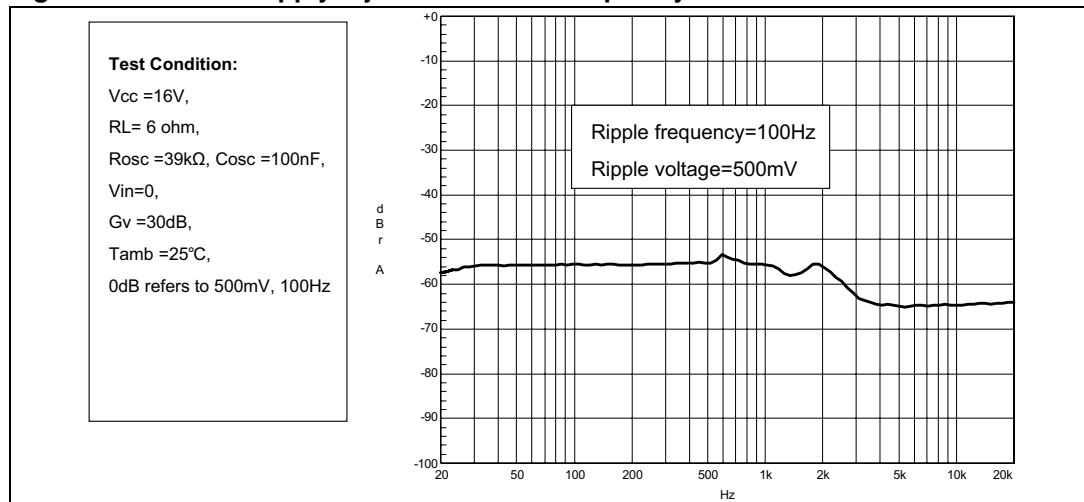

Figure 27. Power dissipation and efficiency vs output power

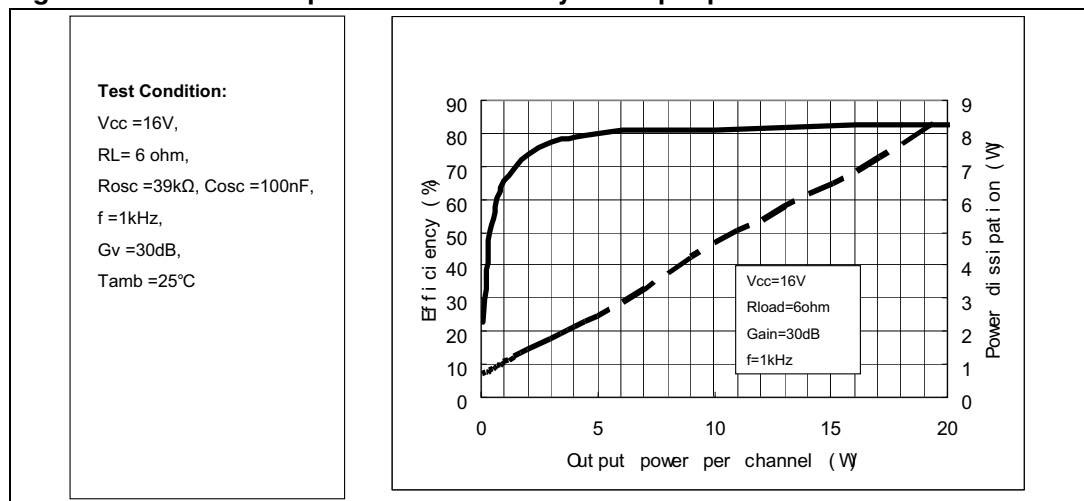

Figure 28. Closed-loop gain vs frequency

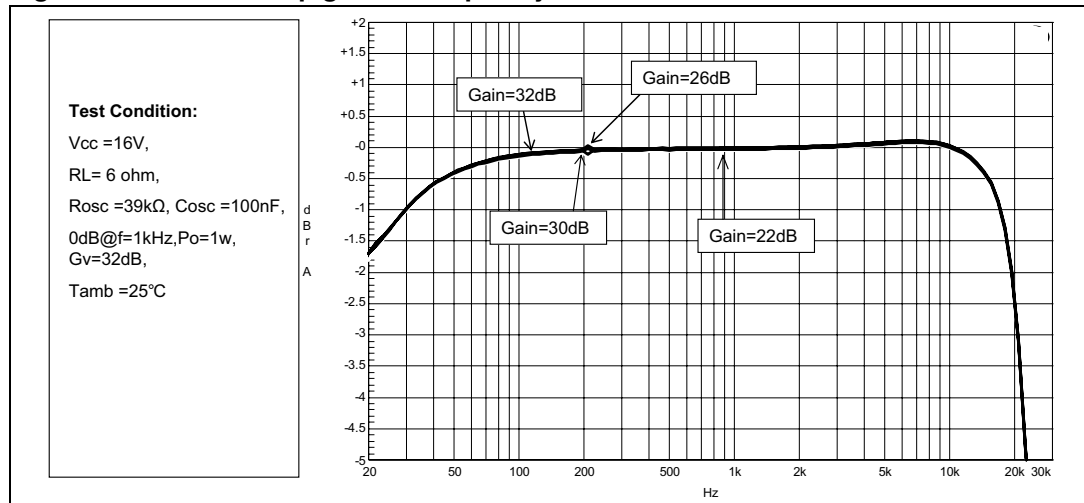

Figure 29. Current consumption vs voltage on pin MUTE

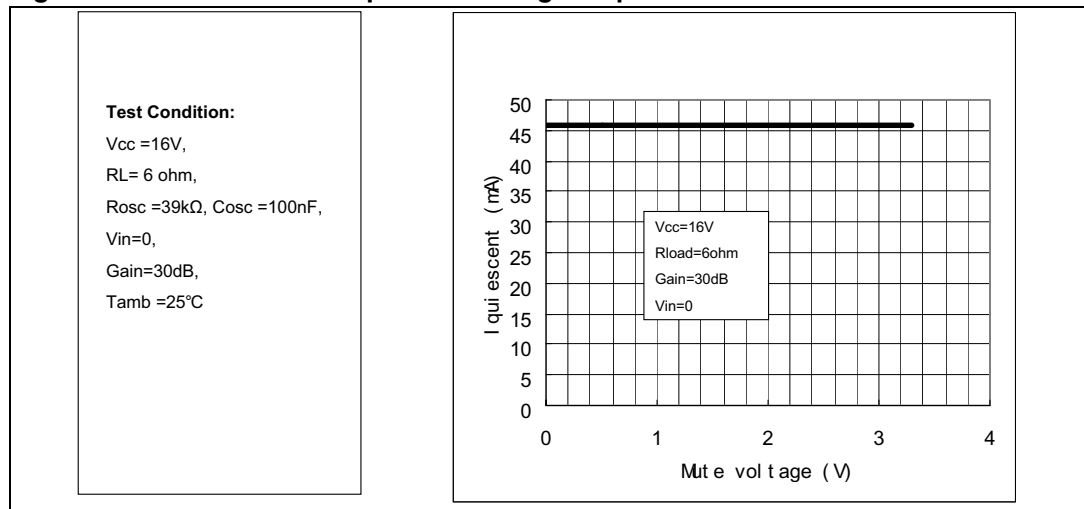

Figure 30. Attenuation vs voltage on pin MUTE

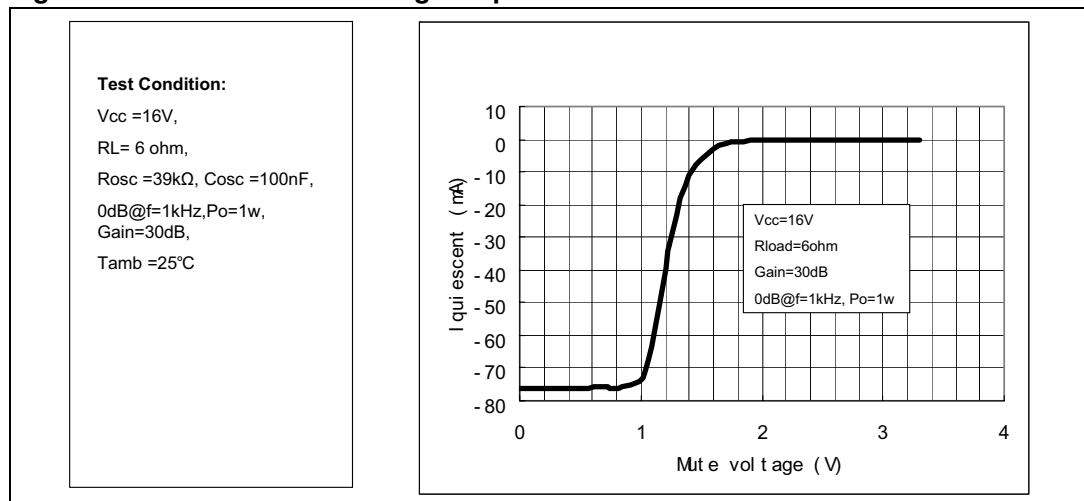

Figure 31. Current consumption vs voltage on pin STBY

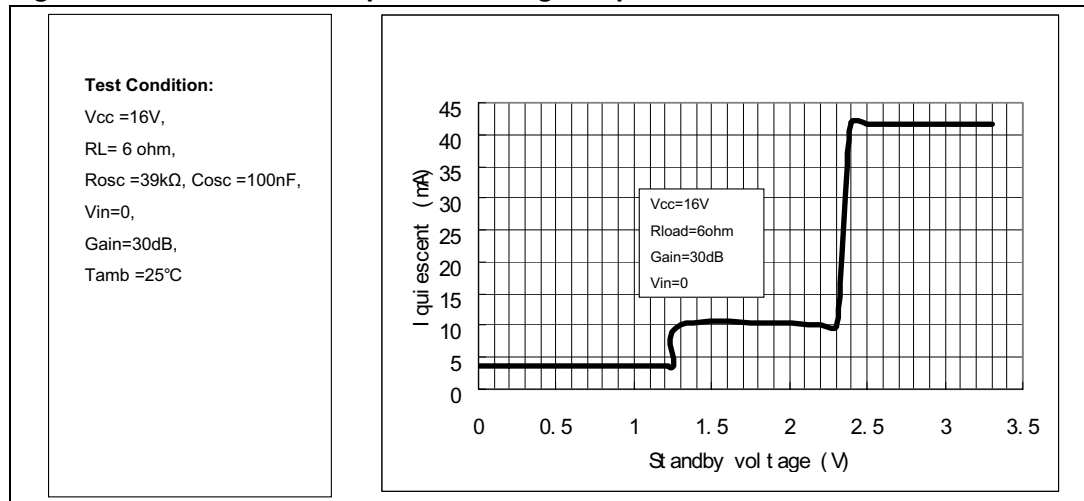
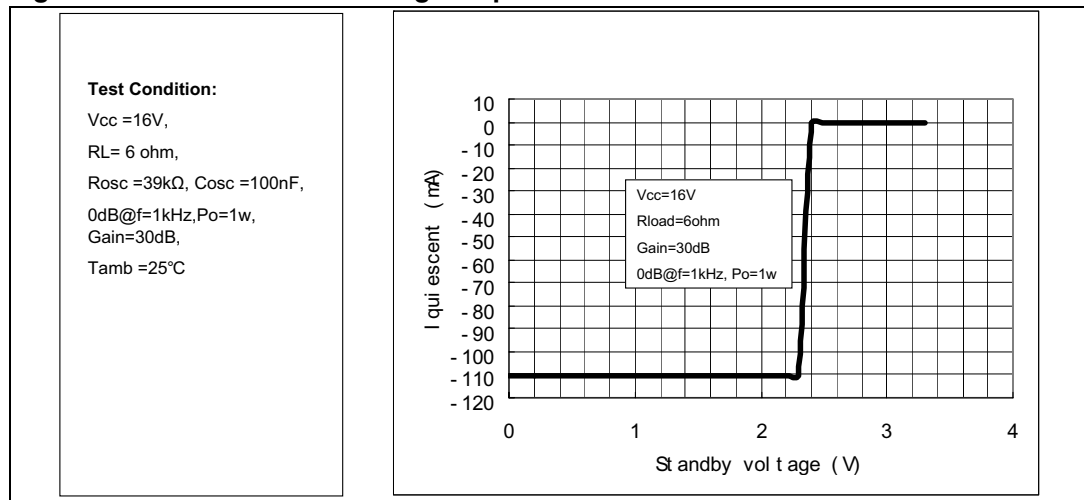

Figure 32. Attenuation vs voltage on pin STBY



4.3 With 8 Ω load at Vs = 18 V

Figure 33. Output power vs supply voltage

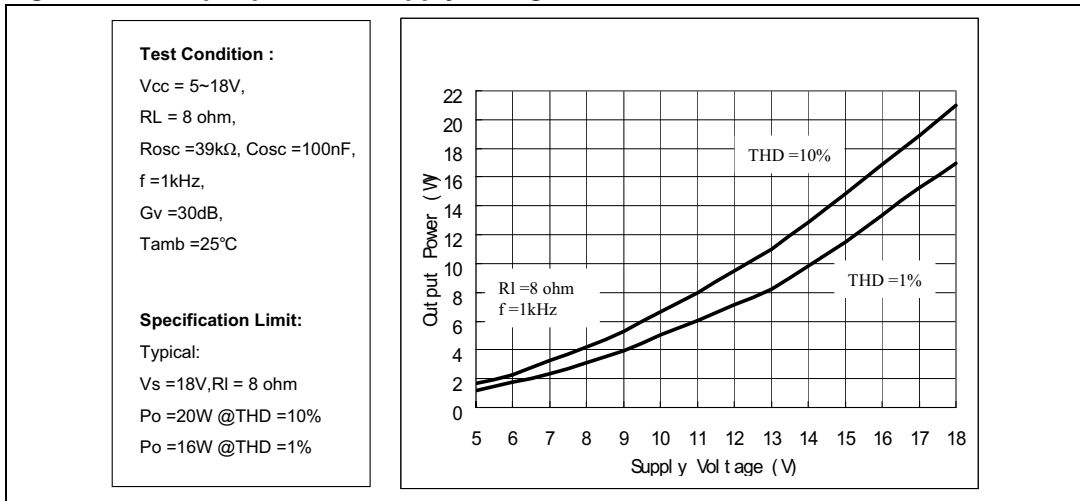

Figure 34. THD vs output power (1 kHz)

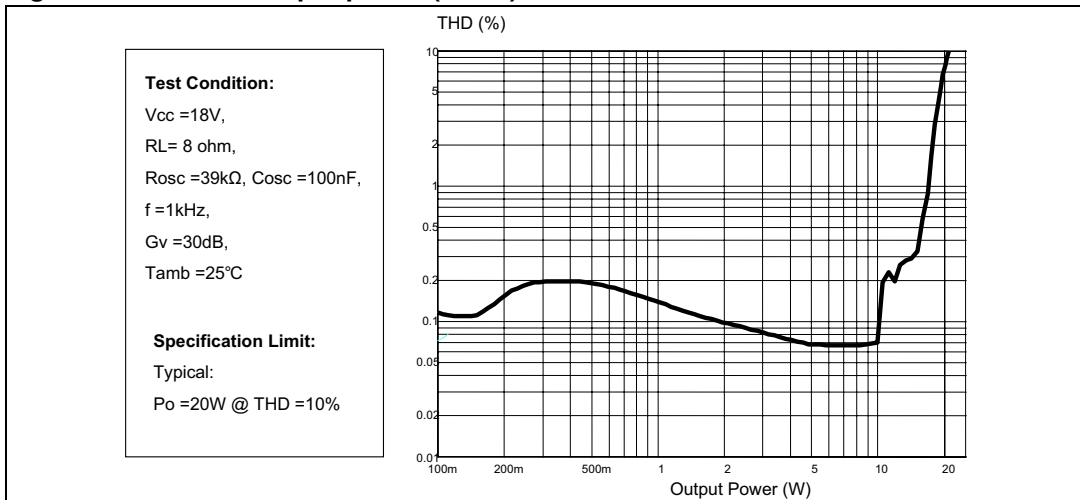

Figure 35. THD vs output power (100 Hz)

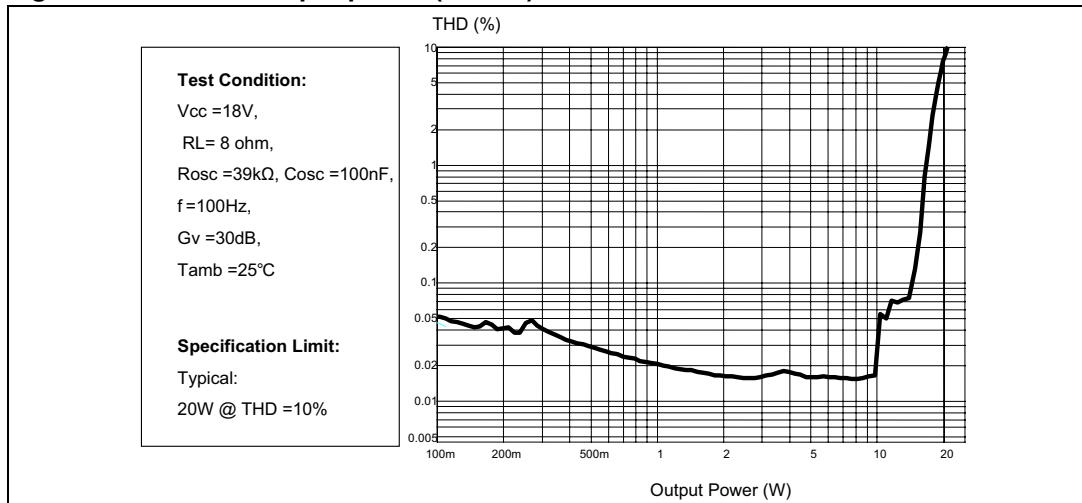

Figure 36. THD vs frequency

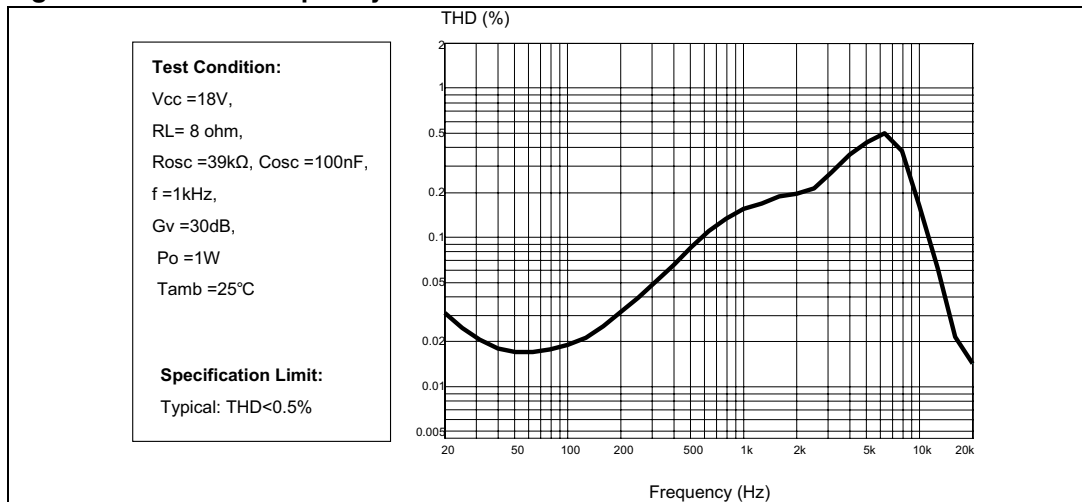

Figure 37. Frequency response

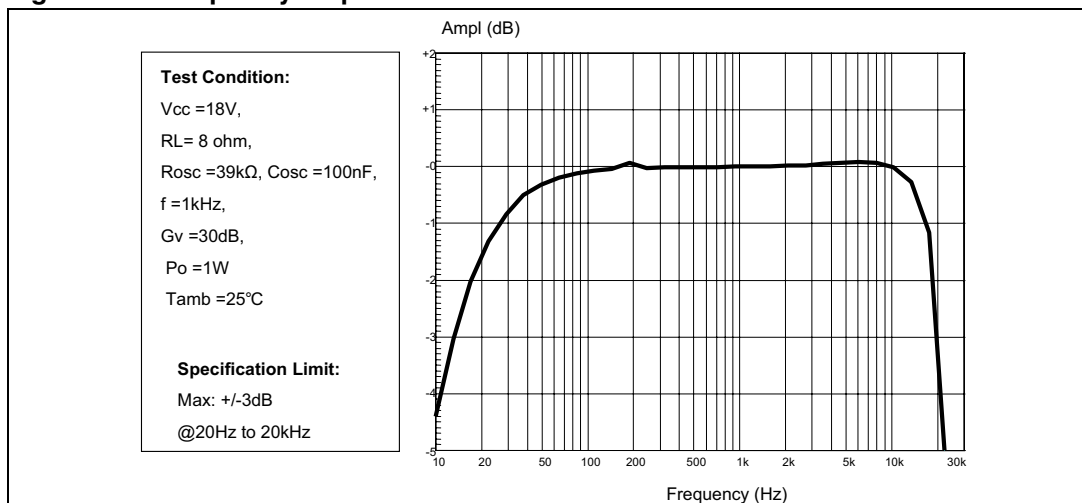

Figure 38. Crosstalk vs frequency

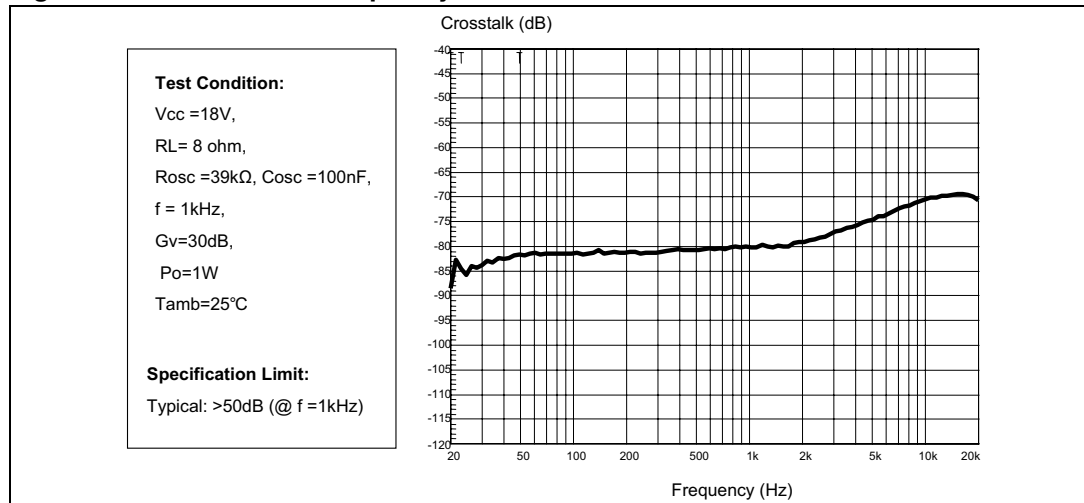

Figure 39. FFT (0 dB)

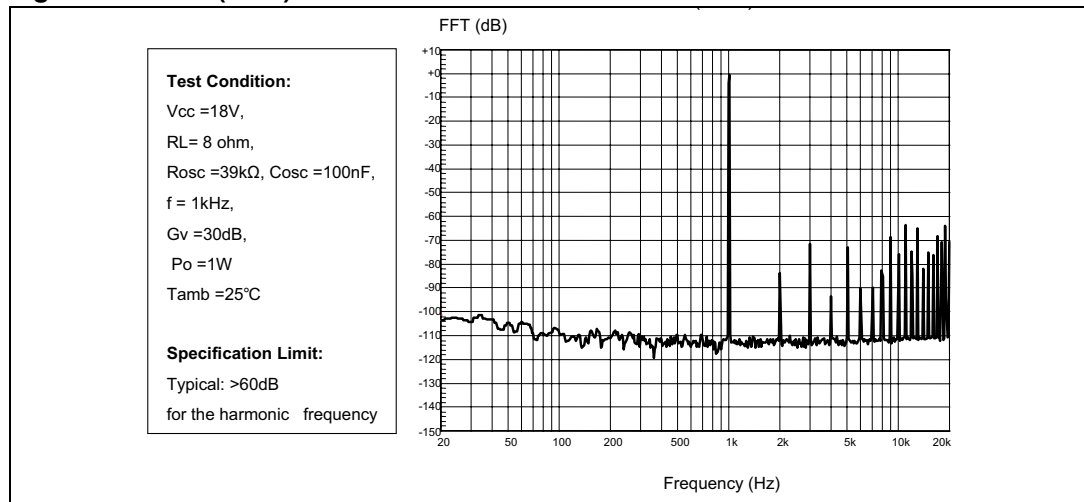

Figure 40. FFT (-60 dB)

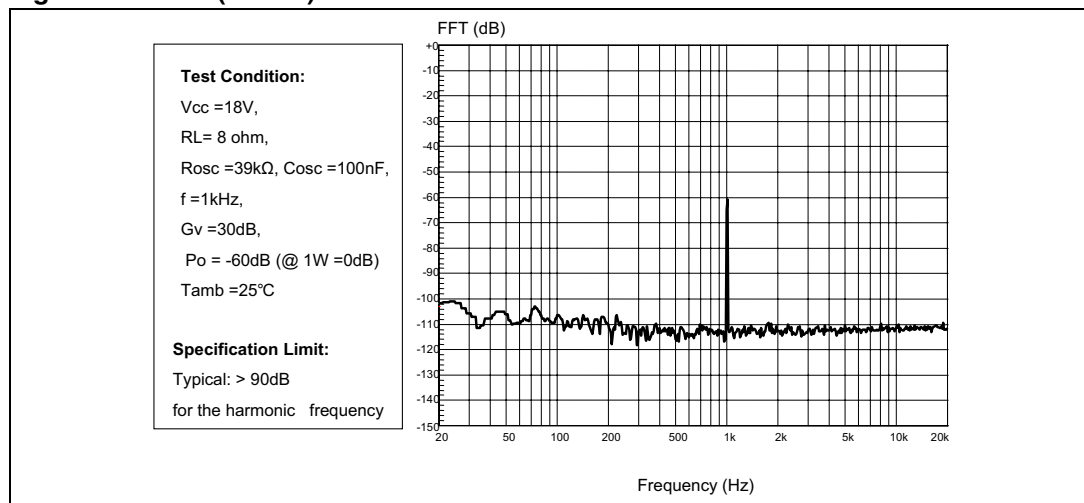

Figure 41. Power supply rejection ratio vs frequency

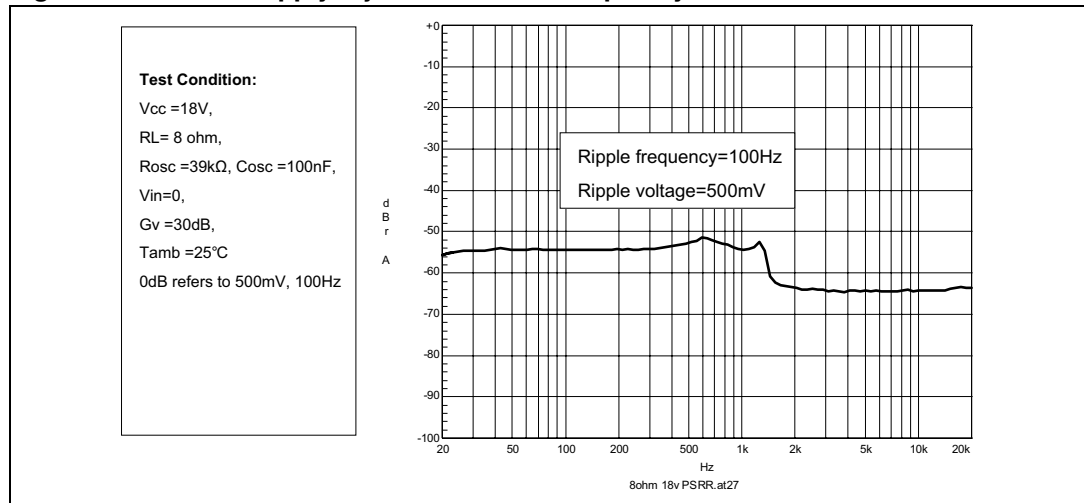

Figure 42. Power dissipation and efficiency vs output power

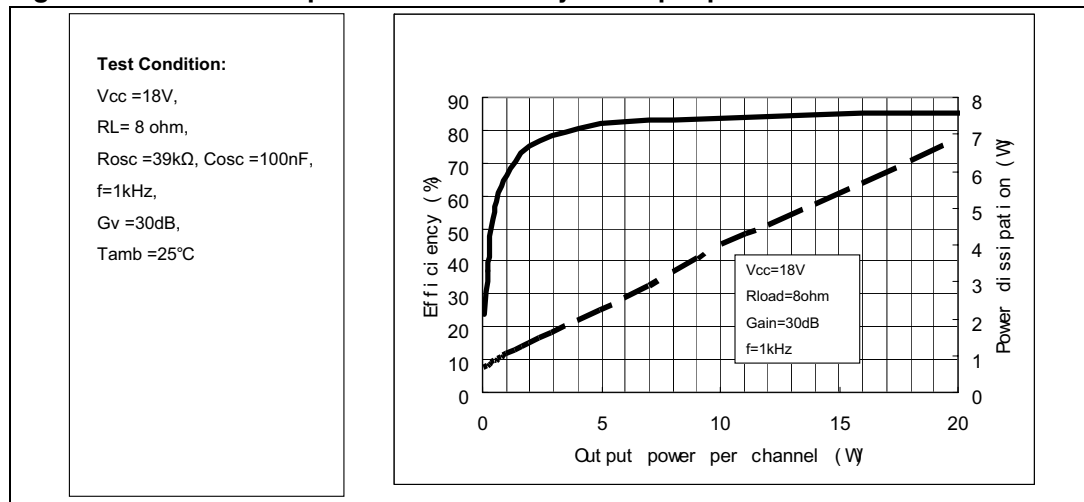

Figure 43. Closed-loop gain vs frequency

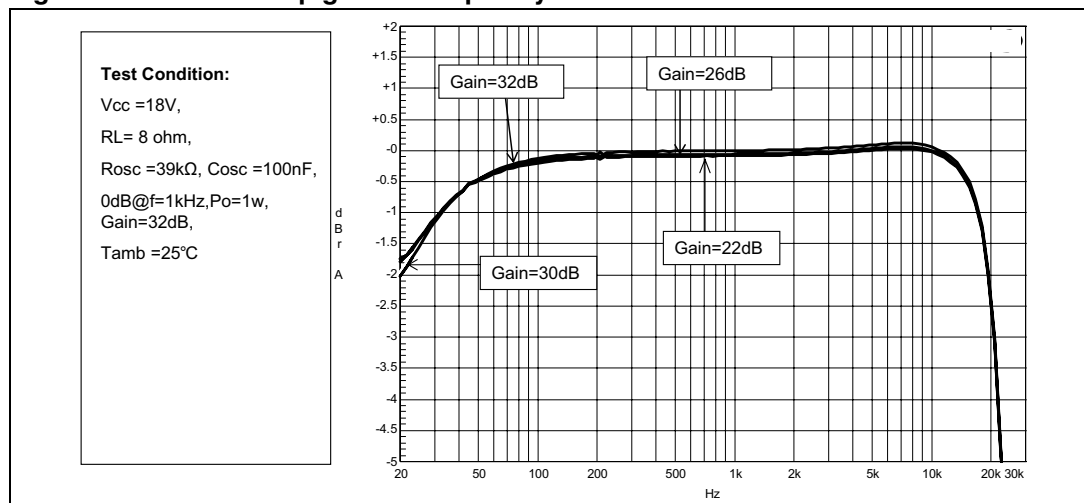

Figure 44. Current consumption vs voltage on pin MUTE

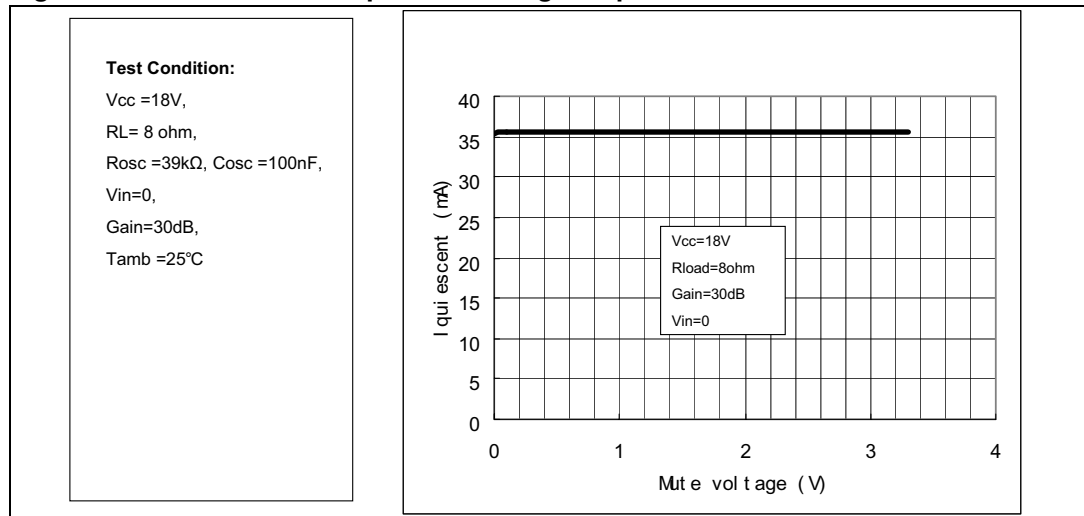

Figure 45. Attenuation vs voltage on pin MUTE

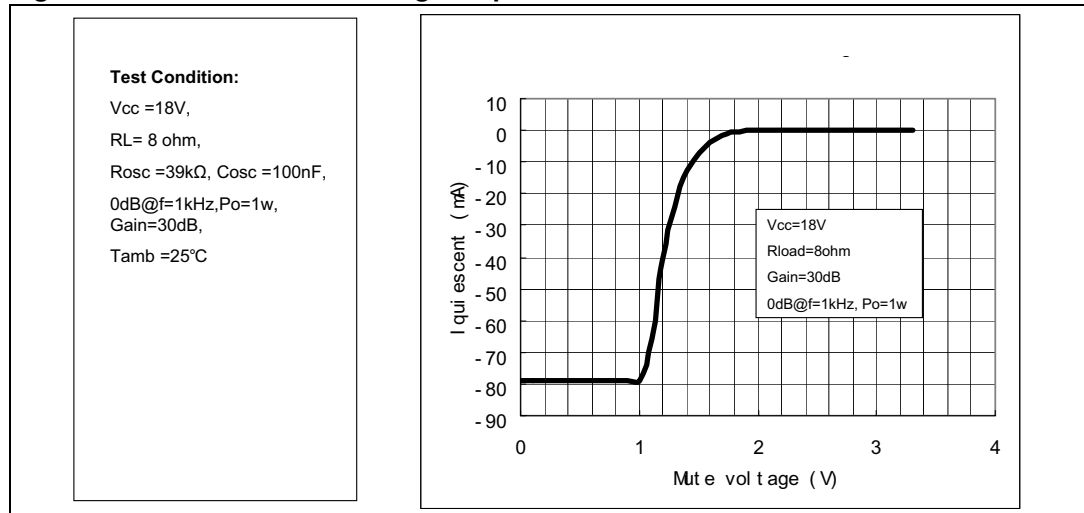

Figure 46. Current consumption vs voltage on pin STBY

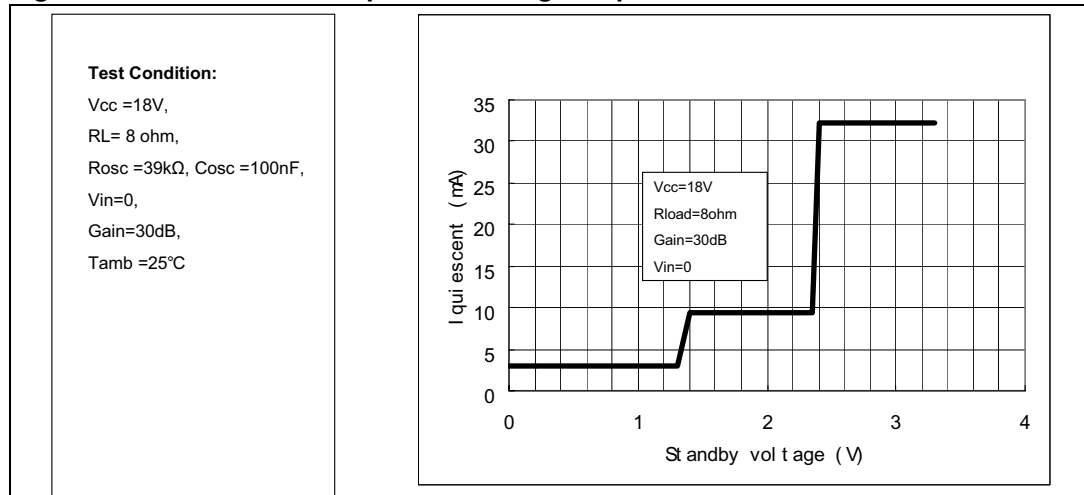

Figure 47. Attenuation vs voltage on pin STBY

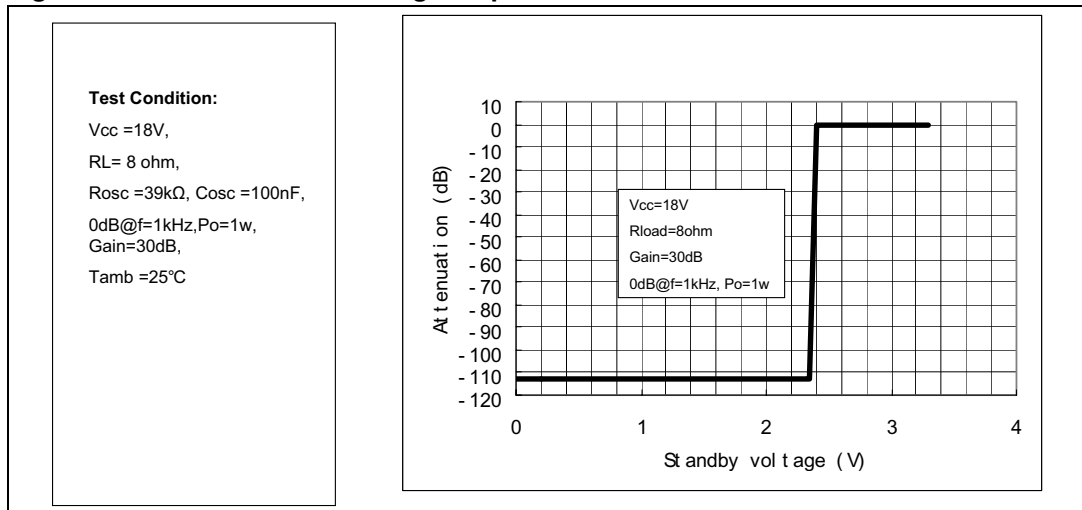
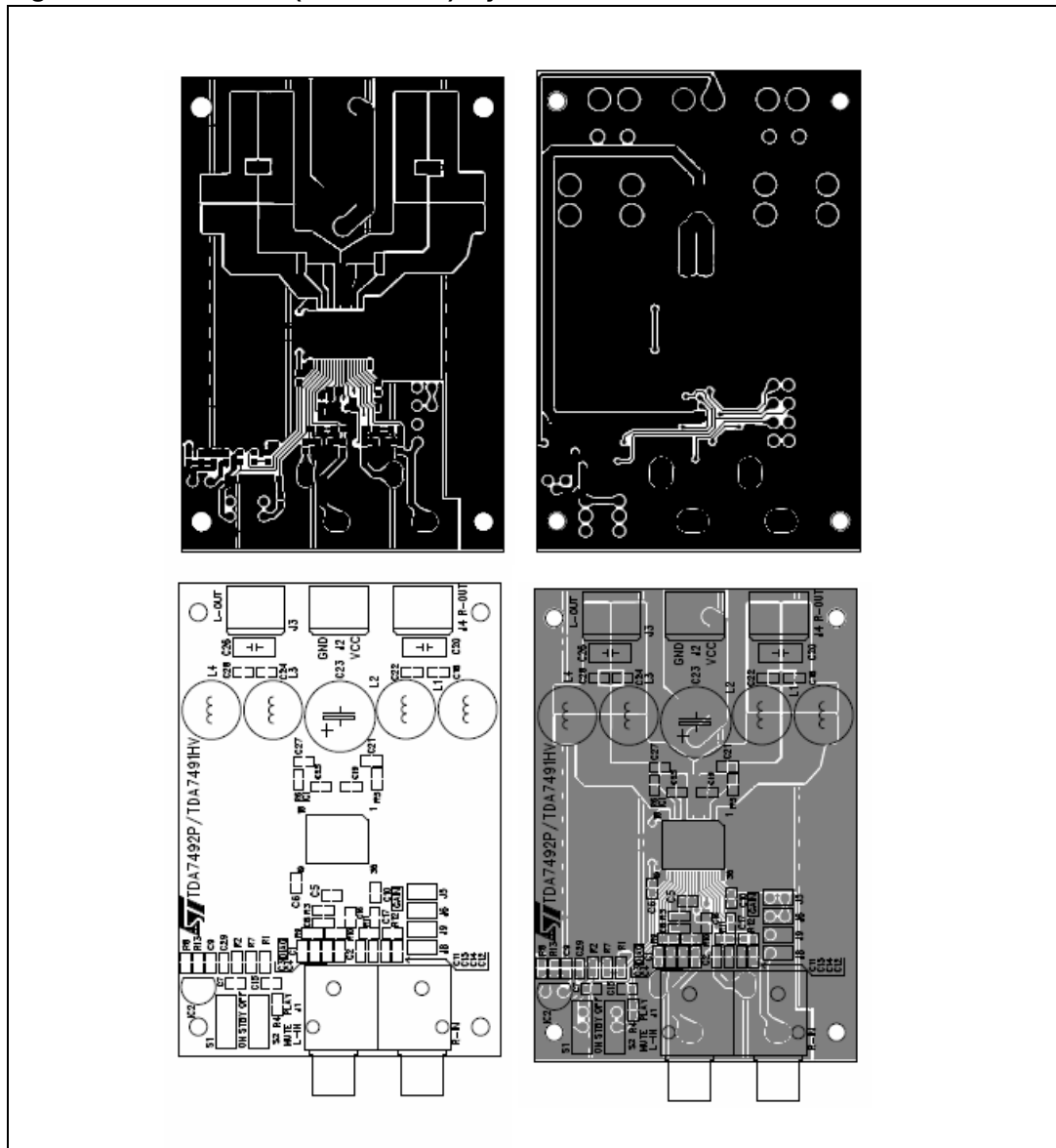

Figure 48. Test board (TDA7491HV) layout



5 Package information

The TDA7491HV comes in a 36-pin PowerSSO package with exposed pad (slug) down.

[Figure 49](#) below shows the package outline and [Table 6](#) gives the dimensions.

Figure 49. PowerSSO-36 slug down outline drawing

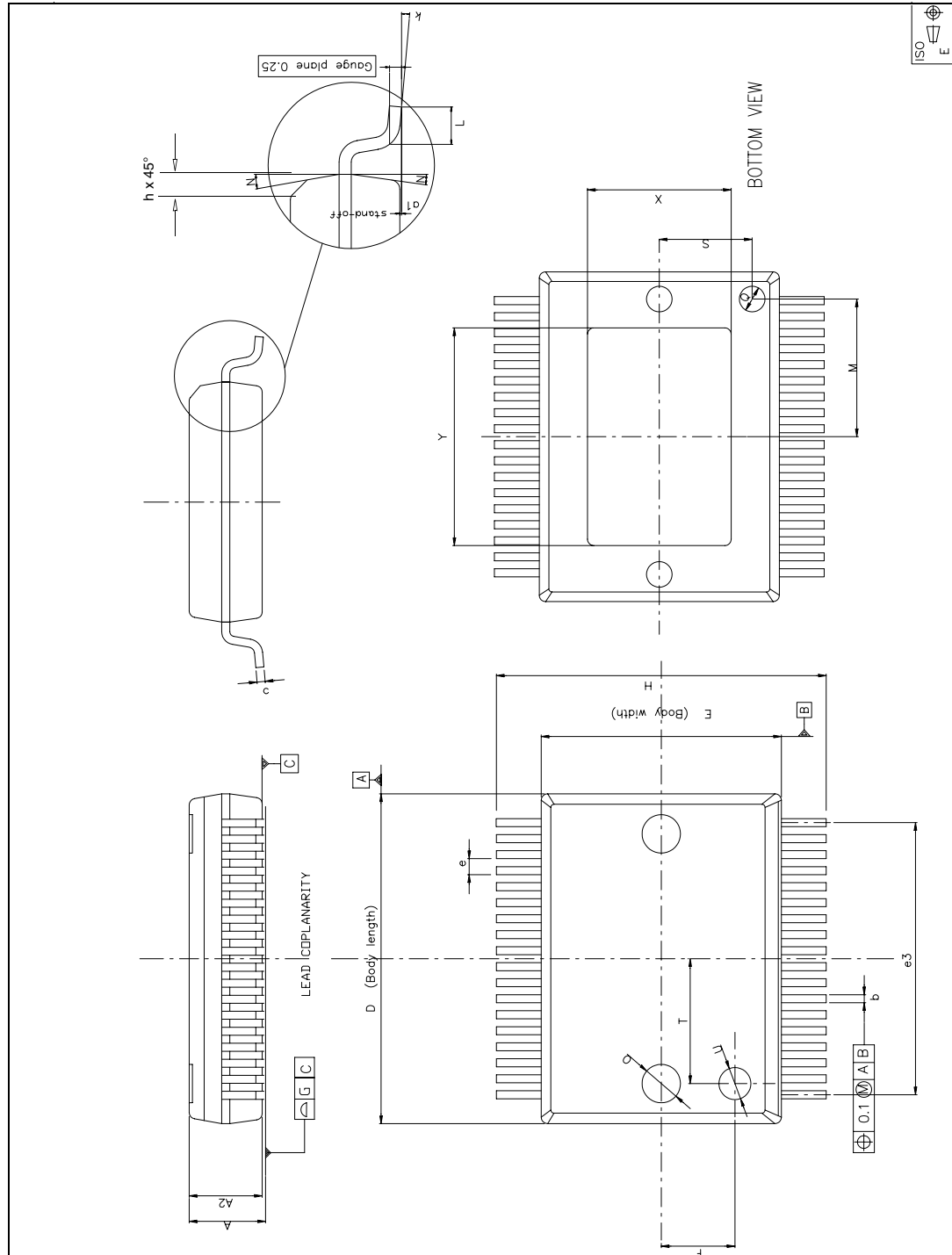

Table 6. PowerSSO-36 slug down dimensions

Symbol	Dimensions in mm			Dimensions in inch		
	Min	Typ	Max	Min	Typ	Max
A	2.15	-	2.47	0.085	-	0.097
A2	2.15	-	2.40	0.085	-	0.094
a1	0	-	0.10	0	-	0.004
b	0.18	-	0.36	0.007	-	0.014
c	0.23	-	0.32	0.009	-	0.013
D	10.10	-	10.50	0.398	-	0.413
E	7.40	-	7.60	0.291	-	0.299
e	-	0.5	-	-	0.020	
e3	-	8.5	-	-	0.335	
F	-	2.3	-	-	0.091	
G	-	-	0.10	-	-	0.004
H	10.10	-	10.50	0.398		0.413
h	-	-	0.40			0.016
k	0	-	8 degrees			8 degrees
L	0.60	-	1.00	0.024		0.039
M	-	4.30	-		0.169	
N	-	-	10 degrees			10 degrees
O	-	1.20	-		0.047	
Q	-	0.80	-		0.031	
S	-	2.90	-		0.114	
T	-	3.65	-		0.144	
U	-	1.00	-		0.039	
X	4.10		4.70	0.161		0.185
Y	6.50		7.10	0.256		0.280

In order to meet environmental requirements, ST offers these devices in ECOPACK[®] packages. These packages have a Pb-free second level interconnect. The category of second Level Interconnect is marked on the package and on the inner box label, in compliance with JEDEC Standard JESD97. The maximum ratings related to soldering conditions are also marked on the inner box label. ECOPACK is an ST trademark.

ECOPACK specifications are available at: <http://www.st.com>.

6 Application circuit

Figure 50. Application circuit

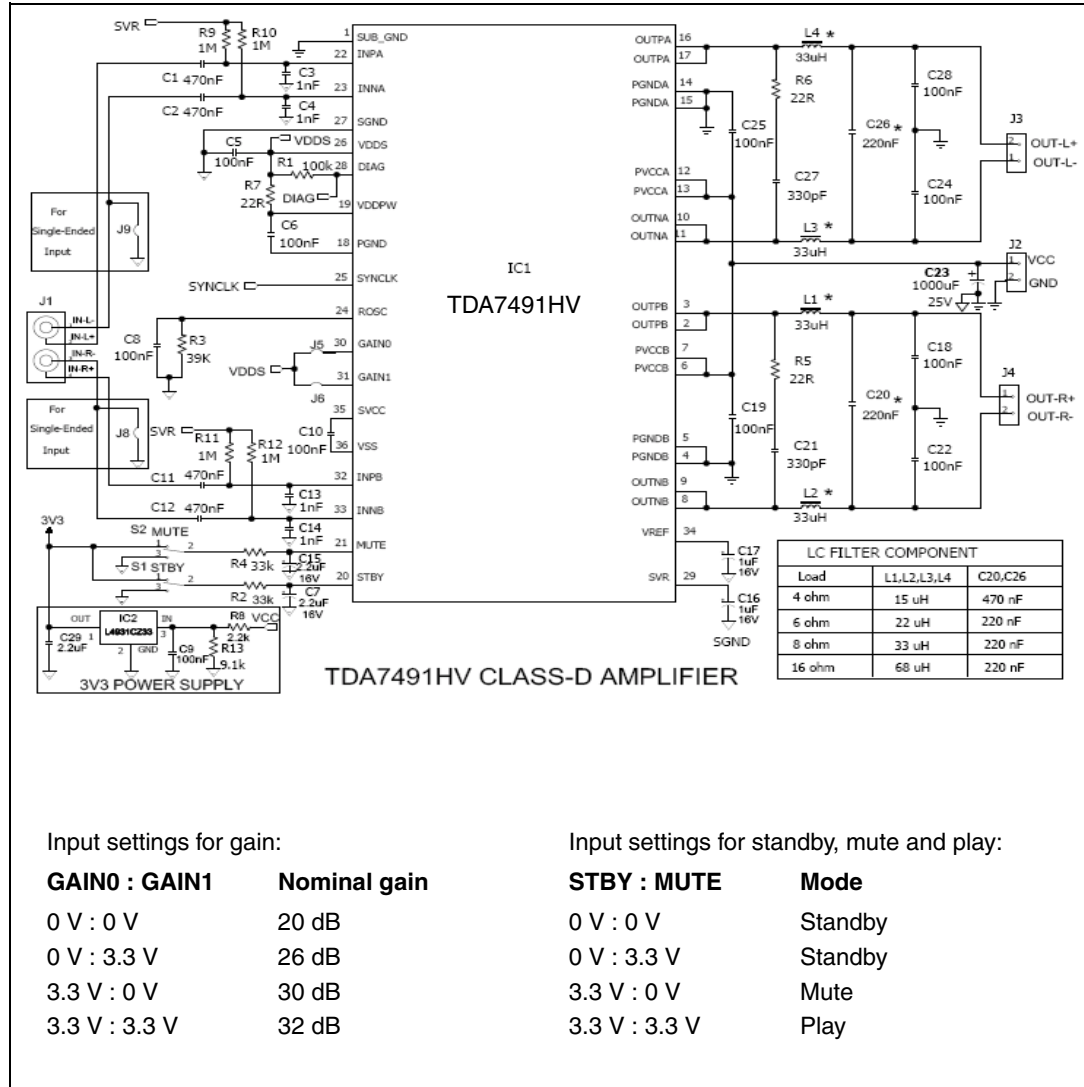

Input settings for gain:

GAIN0 : GAIN1	Nominal gain
0 V : 0 V	20 dB
0 V : 3.3 V	26 dB
3.3 V : 0 V	30 dB
3.3 V : 3.3 V	32 dB

Input settings for standby, mute and play:

STBY : MUTE	Mode
0 V : 0 V	Standby
0 V : 3.3 V	Standby
3.3 V : 0 V	Mute
3.3 V : 3.3 V	Play

7 Application information

7.1 Mode selection

The three operating modes of the TDA7491HV are set by the two inputs STBY (pin 20) and MUTE (pin 21).

- Standby mode: all circuits are turned off, very low current consumption.
- Mute mode: inputs are connected to ground and the positive and negative PWM outputs are at 50% duty cycle.
- Play mode: the amplifiers are active.

The protection functions of the TDA7491HV are realized by pulling down the voltages of the STBY and MUTE inputs shown in *Figure 51*. The input current of the corresponding pins must be limited to 200 μ A.

Table 7. Mode settings

Mode Selection	STBY	MUTE
Standby	L (1)	X (don't care)
Mute	H (1)	L
Play	H	H

1. Drive levels defined in *Table 5: Electrical specifications on page 7*

Figure 51. STBY and MUTE circuit

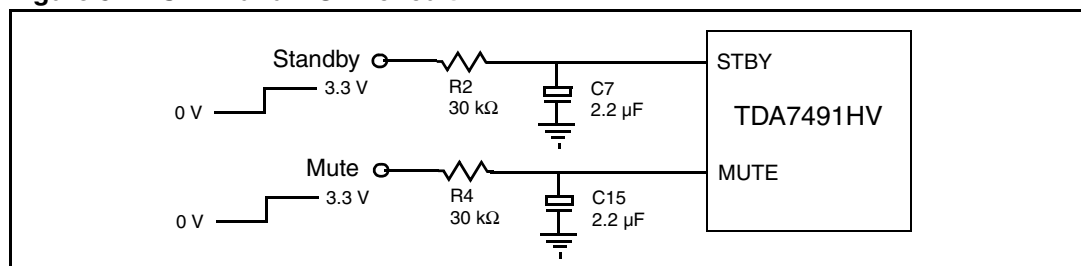
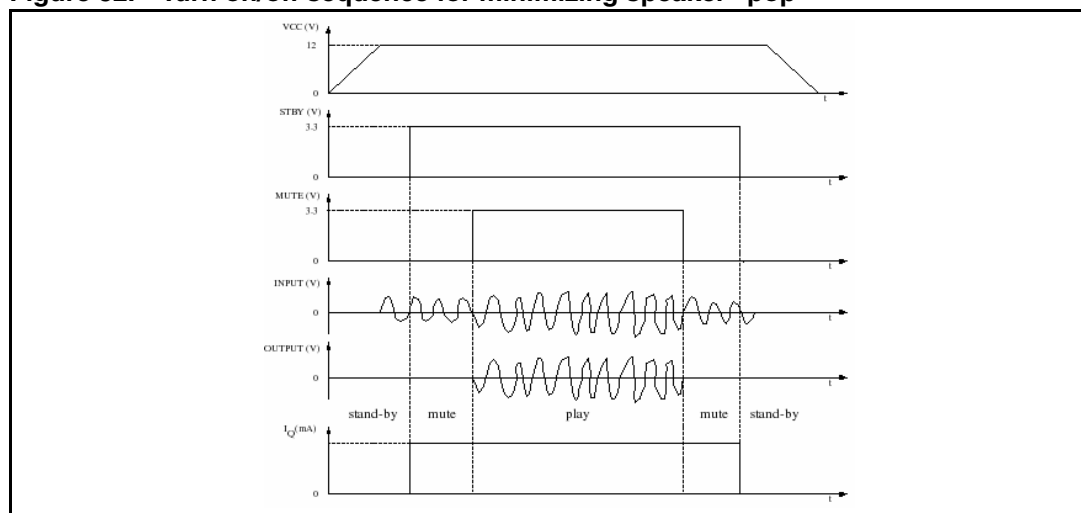

Figure 52. Turn on/off sequence for minimizing speaker “pop”



7.2 Gain setting

The gain of the TDA7491HV is set by the two inputs, GAIN0 (pin 30) and GAIN1 (pin 31). Internally, the gain is set by changing the feedback resistors of the amplifier.

Table 8. Gain settings

GAIN0	GAIN1	Nominal gain, G_v (dB)
0	0	20
0	1	26
1	0	30
1	1	32

7.3 Input resistance and capacitance

The input impedance is set by an internal resistor $R_i = 60\text{ k}\Omega$ (typical). An input capacitor (C_i) is required to couple the AC input signal.

The equivalent circuit and frequency response of the input components are shown in [Figure 53](#). For $C_i = 220\text{ nF}$ the high-pass filter cut-off frequency is below 20 Hz:

$$f_c = 1 / (2 * \pi * R_i * C_i)$$

Figure 53. Device input circuit and frequency response

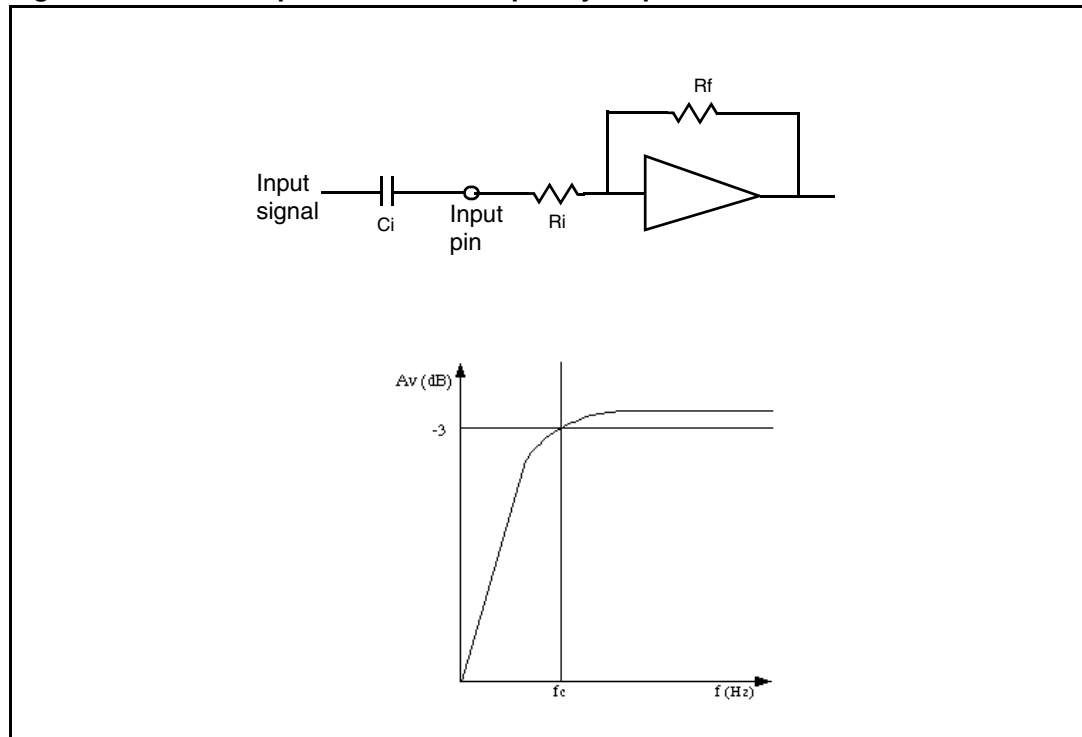

7.4 Internal and external clocks

The clock of the class-D amplifier can be generated internally or can be driven by an external source.

If two or more class-D amplifiers are used in the same system, it is recommended that all devices operate at the same clock frequency. This can be implemented by using one TDA7491HV as master clock, while the other devices are in slave mode (that is, externally clocked). The clock interconnect is via pin SYNCLK of each device. As explained below, SYNCLK is an output in master mode and an input in slave mode.

7.4.1 Master mode (internal clock)

Using the internal oscillator, the output switching frequency, f_{SW} , is controlled by the resistor, R_{OSC} , connected to pin ROSC:

$$f_{SW} = 10^6 / (64 * R_{OSC} + 440) \text{ kHz}$$

where R_{OSC} is in $k\Omega$.

In master mode, pin SYNCLK is used as a clock output pin, whose frequency is:

$$f_{SYNCLK} = 2 * f_{SW}$$

For master mode to operate correctly then resistor R_{OSC} must be less than 60 $k\Omega$ as given below in [Table 9](#).

7.4.2 Slave mode (external clock)

In order to accept an external clock input the pin ROSC must be left open, that is, floating. This forces pin SYNCLK to be internally configured as an input as given in [Table 9](#).

The output switching frequency of the slave devices is:

$$f_{SW} = f_{SYNCLK} / 2$$

Table 9. How to set up SYNCLK

Mode	ROSC	SYNCLK
Master	$R_{OSC} < 60 \text{ k}\Omega$	OUTPUT
Slave	Floating (not connected)	INPUT

Figure 54. Master and Slave Connection

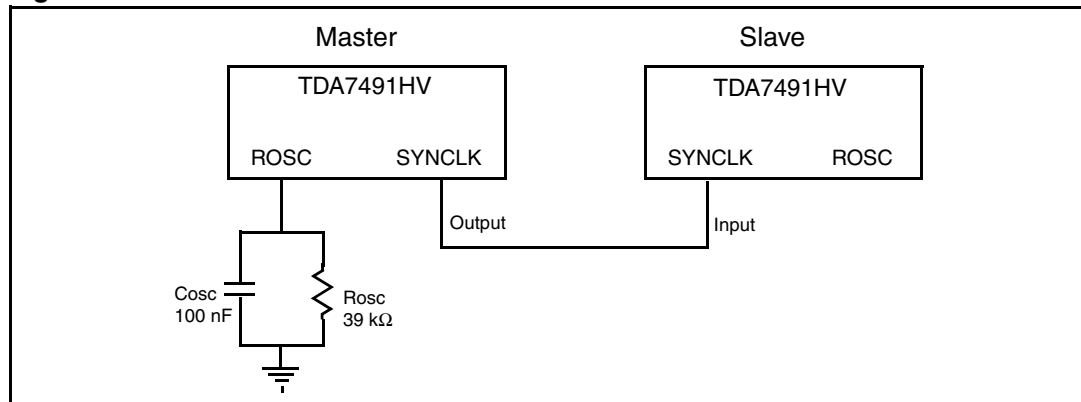

7.5 Filterless modulation

The output modulation scheme of the BTL is called unipolar pulse width modulation (PWM). The differential output voltages change between zero and +Vcc and between zero and -Vcc. This is in contrast to the traditional bipolar PWM outputs which change between +Vcc and -Vcc.

An advantage of this scheme is that it effectively doubles the switching frequency of the differential output waveform. The OUTP and OUTN are in the same phase when the input is zero, then the switching current is low and the loss in the load is small. In practice, a short delay is introduced between these two outputs in order to avoid the BTL output switching at the same time.

TDA7491HV can be used without a filter before the speaker, because the frequency of the TDA7491HV output is beyond the audio frequency, the audio signal can be recovered by the inherent inductance of the speaker and natural filter of the human ear.

Figure 55. Unipolar PWM output

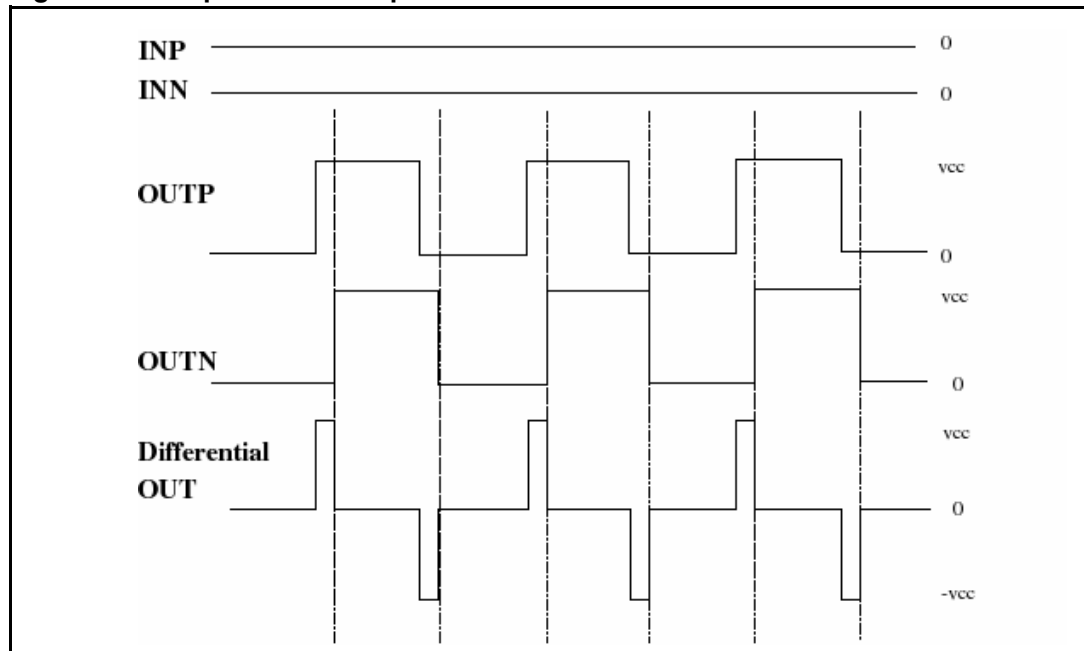

7.6 Output low-pass filter

To avoid EMI problems, it may be necessary to use a low-pass filter before the speaker. The cutoff frequency should be larger than 22 kHz and much lower than the output switching frequency. It is necessary to choose the L-C component values depending on the loud speaker impedance. Some typical values, which give a cut-off frequency of 27 kHz, are shown in *Figure 56* and *Figure 57* below.

Figure 56. Typical LC filter for a 8-Ω speaker

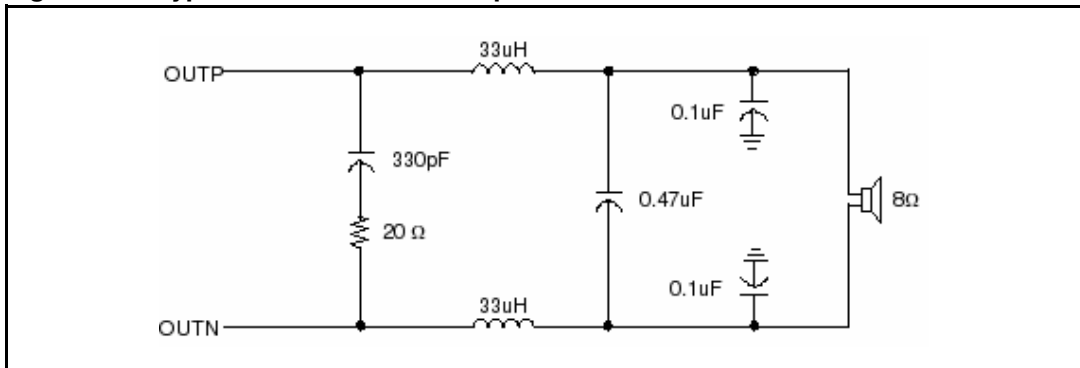
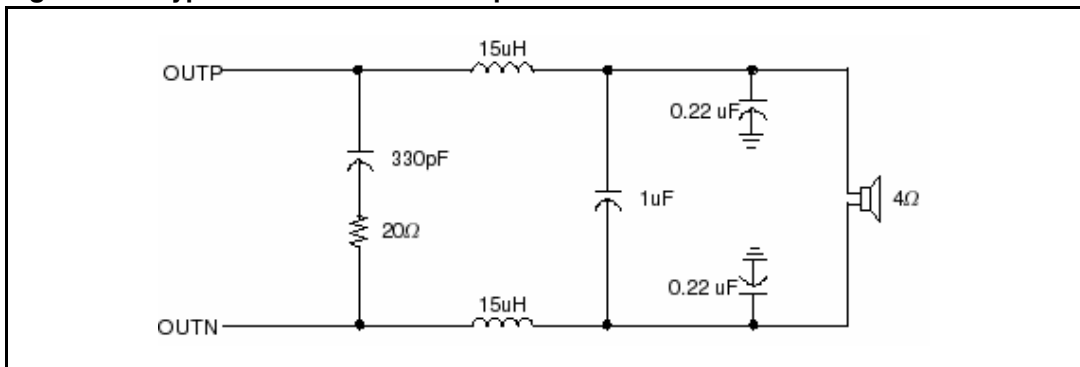

Figure 57. Typical LC filter for a 4-Ω speaker



7.7 Protection function

The TDA7491HV is fully protected against over-voltages, under-voltages, over-currents and thermal overloads as explained here. See also [Table 5: Electrical specifications on page 7](#).

Over voltage protection (OVP)

If the supply voltage exceeds 20 V (nominal) the over voltage protection is activated which forces the outputs to the high-impedance state. When the supply voltage drops to below the threshold value the device restarts.

Under voltage protection (UVP)

If the supply voltage drops below 4 V (nominal) the under voltage protection is activated which forces the outputs to the high-impedance state. When the supply voltage recovers the device restarts.

Over current protection (OCP)

If the output current exceeds 4 A (nominal) the over current protection is activated which forces the outputs to the high-impedance state. Periodically, the device attempts to restart. If the over-current condition is still present then the OCP remains active. The restart time, T_{OC} , is determined by the R-C components connected to pin STBY.

Thermal protection (OTP)

If the junction temperature, T_j , reaches 145° C (nominally), the device goes to mute mode and the positive and negative PWM outputs are forced to 50% duty cycle. At $T_j = 155°$ C (nominally), the device shuts down and the output is forced to the high impedance state. When the device cools sufficiently the device restarts.

7.8 Diagnostic output

The output pin DIAG is an open drain transistor. When the protection is activated it is in the high-impedance state. The pin can be connected to a power supply (< 20 V) by a pull-up resistor whose value is limited by the maximum sinking current (200 μ A) of the pin.

Figure 58. Behavior of pin DIAG for various protection conditions

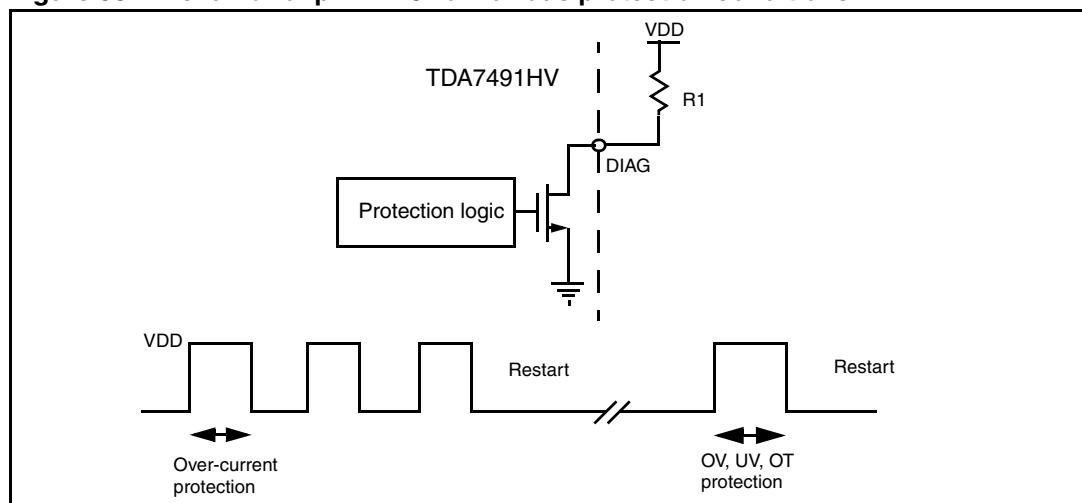

7.9 Heatsink requirements

A thermal resistance of 24° C/W can be obtained using the PCB copper ground layer with 16 vias connecting it to the contact area for the slug. Ensure that the copper ground area is a nominal 9 cm² for 24° C/W.

Figure 59 shows the derating curves for copper areas of 4 cm² and 9 cm².

As with most amplifiers, the power dissipated within the device depends primarily on the supply voltage, the load impedance and the output modulation level.

The maximum estimated power dissipation for the TDA7491HV is less than 4 W. When properly mounted on the above PCB the junction temperature could increase by 96° C. However, with a musical program the dissipated power is about 40% less, leading to a temperature increase of around 60° C. Even at the maximum recommended ambient temperature for consumer applications of 50° C there is still a clear safety margin before the maximum junction temperature (150° C) is reached.

Figure 59. Power derating curves for PCB used as heatsink

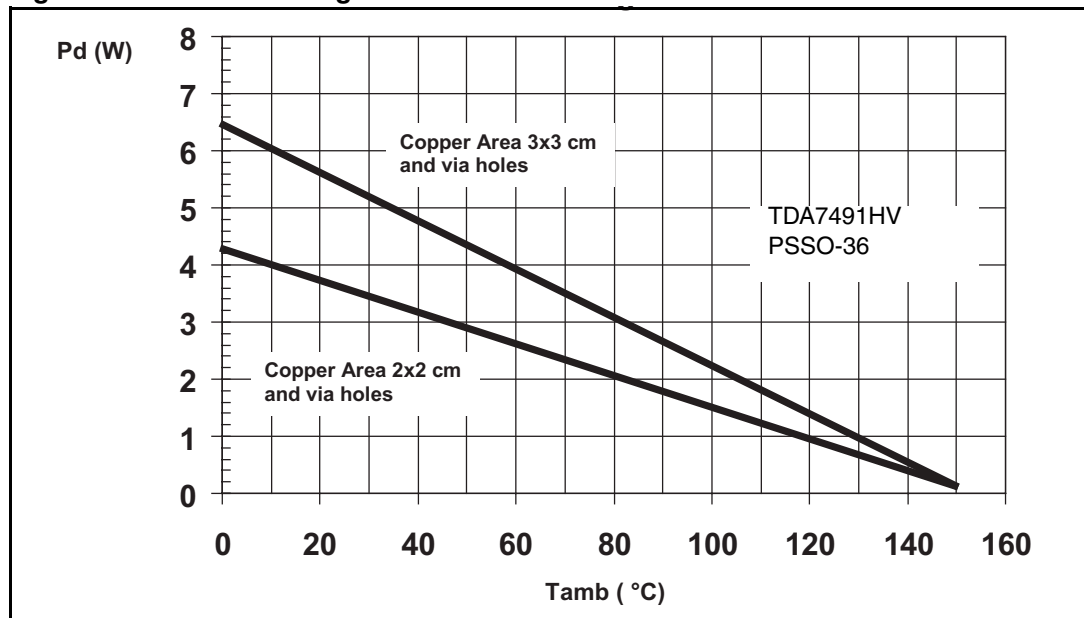

8 Revision history

Table 10. Document revision history

Date	Revision	Changes
02-Jul-2007	1	Initial release.
03-Oct-2008	2	Updated AMR table Updated Chapter 4: Characterization curves on page 9 Added Figure 48: Test board (TDA7491HV) layout on page 26 Updated Figure 49: PowerSSO-36 slug down outline drawing on page 27 and Table 6: PowerSSO-36 slug down dimensions on page 28 Updated Figure 50: Application circuit on page 29

Please Read Carefully:

Information in this document is provided solely in connection with ST products. STMicroelectronics NV and its subsidiaries ("ST") reserve the right to make changes, corrections, modifications or improvements, to this document, and the products and services described herein at any time, without notice.

All ST products are sold pursuant to ST's terms and conditions of sale.

Purchasers are solely responsible for the choice, selection and use of the ST products and services described herein, and ST assumes no liability whatsoever relating to the choice, selection or use of the ST products and services described herein.

No license, express or implied, by estoppel or otherwise, to any intellectual property rights is granted under this document. If any part of this document refers to any third party products or services it shall not be deemed a license grant by ST for the use of such third party products or services, or any intellectual property contained therein or considered as a warranty covering the use in any manner whatsoever of such third party products or services or any intellectual property contained therein.

UNLESS OTHERWISE SET FORTH IN ST'S TERMS AND CONDITIONS OF SALE ST DISCLAIMS ANY EXPRESS OR IMPLIED WARRANTY WITH RESPECT TO THE USE AND/OR SALE OF ST PRODUCTS INCLUDING WITHOUT LIMITATION IMPLIED WARRANTIES OF MERCHANTABILITY, FITNESS FOR A PARTICULAR PURPOSE (AND THEIR EQUIVALENTS UNDER THE LAWS OF ANY JURISDICTION), OR INFRINGEMENT OF ANY PATENT, COPYRIGHT OR OTHER INTELLECTUAL PROPERTY RIGHT.

UNLESS EXPRESSLY APPROVED IN WRITING BY AN AUTHORIZED ST REPRESENTATIVE, ST PRODUCTS ARE NOT RECOMMENDED, AUTHORIZED OR WARRANTED FOR USE IN MILITARY, AIR CRAFT, SPACE, LIFE SAVING, OR LIFE SUSTAINING APPLICATIONS, NOR IN PRODUCTS OR SYSTEMS WHERE FAILURE OR MALFUNCTION MAY RESULT IN PERSONAL INJURY, DEATH, OR SEVERE PROPERTY OR ENVIRONMENTAL DAMAGE. ST PRODUCTS WHICH ARE NOT SPECIFIED AS "AUTOMOTIVE GRADE" MAY ONLY BE USED IN AUTOMOTIVE APPLICATIONS AT USER'S OWN RISK.

Resale of ST products with provisions different from the statements and/or technical features set forth in this document shall immediately void any warranty granted by ST for the ST product or service described herein and shall not create or extend in any manner whatsoever, any liability of ST.

ST and the ST logo are trademarks or registered trademarks of ST in various countries.

Information in this document supersedes and replaces all information previously supplied.

The ST logo is a registered trademark of STMicroelectronics. All other names are the property of their respective owners.

© 2008 STMicroelectronics - All rights reserved

STMicroelectronics group of companies

Australia - Belgium - Brazil - Canada - China - Czech Republic - Finland - France - Germany - Hong Kong - India - Israel - Italy - Japan - Malaysia - Malta - Morocco - Singapore - Spain - Sweden - Switzerland - United Kingdom - United States of America

www.st.com