

TVS Diodes

Transient Voltage Suppressor Diodes

ESD3V3U4ULC

Ultra Low Capacitance ESD Array

ESD3V3U4ULC

Data Sheet

Revision 0.9, 2010-10-14
Preliminary

Industrial and Multi-Market

Edition 2010-10-14

**Published by
Infineon Technologies AG
81726 Munich, Germany**

**© 2010 Infineon Technologies AG
All Rights Reserved.**

Legal Disclaimer

The information given in this document shall in no event be regarded as a guarantee of conditions or characteristics. With respect to any examples or hints given herein, any typical values stated herein and/or any information regarding the application of the device, Infineon Technologies hereby disclaims any and all warranties and liabilities of any kind, including without limitation, warranties of non-infringement of intellectual property rights of any third party.

Information

For further information on technology, delivery terms and conditions and prices, please contact the nearest Infineon Technologies Office (www.infineon.com).

Warnings

Due to technical requirements, components may contain dangerous substances. For information on the types in question, please contact the nearest Infineon Technologies Office.

Infineon Technologies components may be used in life-support devices or systems only with the express written approval of Infineon Technologies, if a failure of such components can reasonably be expected to cause the failure of that life-support device or system or to affect the safety or effectiveness of that device or system. Life support devices or systems are intended to be implanted in the human body or to support and/or maintain and sustain and/or protect human life. If they fail, it is reasonable to assume that the health of the user or other persons may be endangered.

Revision History

Page or Item	Subjects (major changes since previous revision)
Revision 0.9, 2010-10-14	

Trademarks of Infineon Technologies AG

AURIX™, BlueMoon™, COMNEON™, C166™, CROSSAVE™, CanPAK™, CIPOST™, CoolMOS™, CoolSET™, CORECONTROL™, DAVE™, EasyPIM™, EconoBRIDGE™, EconoDUAL™, EconoPACK™, EconoPIM™, EiceDRIVER™, EUPEC™, FCOS™, HITFET™, HybridPACK™, ISOFACE™, I²RF™, IsoPACK™, MIPAQ™, ModSTACK™, my-d™, NovalithIC™, OmniTune™, OptiMOS™, ORIGA™, PROFET™, PRO-SIL™, PRIMARION™, PrimePACK™, RASIC™, ReverSave™, SatRIC™, SIEGET™, SINDRION™, SMARTi™, SmartLEWIS™, TEMPFET™, thinQ!™, TriCore™, TRENCHSTOP™, X-GOLD™, XMM™, X-PMU™, XPOSSYS™.

Other Trademarks

Advance Design System™ (ADS) of Agilent Technologies, AMBA™, ARM™, MULTI-ICE™, PRIMECELL™, REALVIEW™, THUMB™ of ARM Limited, UK. AUTOSAR™ is licensed by AUTOSAR development partnership. Bluetooth™ of Bluetooth SIG Inc. CAT-iq™ of DECT Forum. COLOSSUS™, FirstGPS™ of Trimble Navigation Ltd. EMV™ of EMVCo, LLC (Visa Holdings Inc.). EPCOS™ of Epcos AG. FLEXGO™ of Microsoft Corporation. FlexRay™ is licensed by FlexRay Consortium. HYPERTERMINAL™ of Hilgraeve Incorporated. IEC™ of Commission Electrotechnique Internationale. IrDA™ of Infrared Data Association Corporation. ISO™ of INTERNATIONAL ORGANIZATION FOR STANDARDIZATION. MATLAB™ of MathWorks, Inc. MAXIM™ of Maxim Integrated Products, Inc. MICROTEC™, NUCLEUS™ of Mentor Graphics Corporation. Mifare™ of NXP. MIPI™ of MIPI Alliance, Inc. MIPS™ of MIPS Technologies, Inc., USA. muRata™ of MURATA MANUFACTURING CO., MICROWAVE OFFICE™ (MWO) of Applied Wave Research Inc., OmniVision™ of OmniVision Technologies, Inc. Openwave™ Openwave Systems Inc. RED HAT™ Red Hat, Inc. RFMD™ RF Micro Devices, Inc. SIRIUS™ of Sirius Sattelite Radio Inc. SOLARIS™ of Sun Microsystems, Inc. SPANSION™ of Spansion LLC Ltd. Symbian™ of Symbian Software Limited. TAIYO YUDEN™ of Taiyo Yuden Co. TEAKLITE™ of CEVA, Inc. TEKTRONIX™ of Tektronix Inc. TOKO™ of TOKO KABUSHIKI KAISHA TA. UNIX™ of X/Open Company Limited. VERILOG™, PALLADIUM™ of Cadence Design Systems, Inc. VLYNQ™ of Texas Instruments Incorporated. VXWORKS™, WIND RIVER™ of WIND RIVER SYSTEMS, INC. ZETEX™ of Diodes Zetex Limited.

Last Trademarks Update 2010-06-09

Table of Contents

	Table of Contents	4
	List of Figures	5
	List of Tables	6
1	Ultra Low Capacitance ESD Array	7
1.1	Features	7
1.2	Application Examples	7
2	Product Description	7
3	Characteristics	8
3.1	Electrical Characteristics at $T_A = 25\text{ °C}$, unless otherwise specified	8
3.2	Typical Performance characteristics at $T_A = 25\text{ °C}$, unless otherwise specified	10
4	Application Information	13
5	Ordering information scheme	14
6	Package Information	15
6.1	PG-TSLP-9-1	15
	References	16
	Terminology	17

List of Figures

Figure 1	a) Pin Configuration and b) Schematic Diagram	7
Figure 2	Definitions of electrical characteristics [1]	8
Figure 3	Line capacitance $C_L = f(V_R)$	10
Figure 4	Reverse current $I_R = f(T_A)$, $V_R = 3.3\text{ V}$	10
Figure 5	Forward characteristic, $I_F = f(V_F)$, current forced	11
Figure 6	Reverse characteristic, $I_R = (V_R)$, voltage forced	11
Figure 7	Reverse TLP characteristic ^{Note: [2]}	12
Figure 8	Forward TLP characteristic ^{Note: [2]}	12
Figure 9	USB3.0 structure with ESD protection devices [3]	13
Figure 10	Ordering Information Scheme.	14
Figure 11	PG-TSLP-9-1: Package Overview	15
Figure 12	PG-TSLP-9-1: Footprint	15
Figure 13	PG-TSLP-9-1: Packing	15
Figure 14	PG-TSLP-9-1: Marking	15

List of Tables

Table 1	Ordering information	7
Table 2	Maximum Rating at $T_A = 25\text{ °C}$, unless otherwise specified	8
Table 3	DC characteristics at $T_A = 25\text{ °C}$, unless otherwise specified	8
Table 4	RF characteristics at $T_A = 25\text{ °C}$, unless otherwise specified	9
Table 5	ESD characteristics at $T_A = 25\text{ °C}$, unless otherwise specified	9

1 Ultra Low Capacitance ESD Array

1.1 Features

- ESD / Transient protection of high speed data lines exceeding :
 - IEC61000-4-2 (ESD) : ± 20 kV (air/contact)
 - IEC61000-4-4 (EFT) : 2.5 kV (5/50ns)
 - IEC61000-4-5 (Surge) : 3 A (8/20ns)
- Maximum working voltage: $V_{RWM} = 3.3$ V
- Very low reverse current: $I_R = 1$ nA (typical)
- Extremely low capacitance $C_L = 0.4$ pF I/O to GND (typical)
- Very low reverse clamping voltage: $V_{CL} = 9$ V at $I_{PP} = 16$ A (typical)
- Very low forward clamping voltage: $V_{FC} = 6$ V at $I_{PP} = 16$ A (typical)
- Very low reverse dynamic resistance: $R_{dyn,rev} = 0.2 \Omega$ (typical)
- TSLP-9-1 package with pad pitch 0.5 mm
- Optimized pad design to simplify PCB layout
- Pb-free and Halogen-Free package (RoHS compliant)



1.2 Application Examples

- USB 3.0, 10/100/1000 Ethernet, Firewire
- DVI, HDMI, S-ATA, DisplayPort, Mobile communication, LCD displays, Camera
- Consumer products (STB, MP3, DVD, DSC, ...) Notebooks and desktop computers, peripherals

2 Product Description

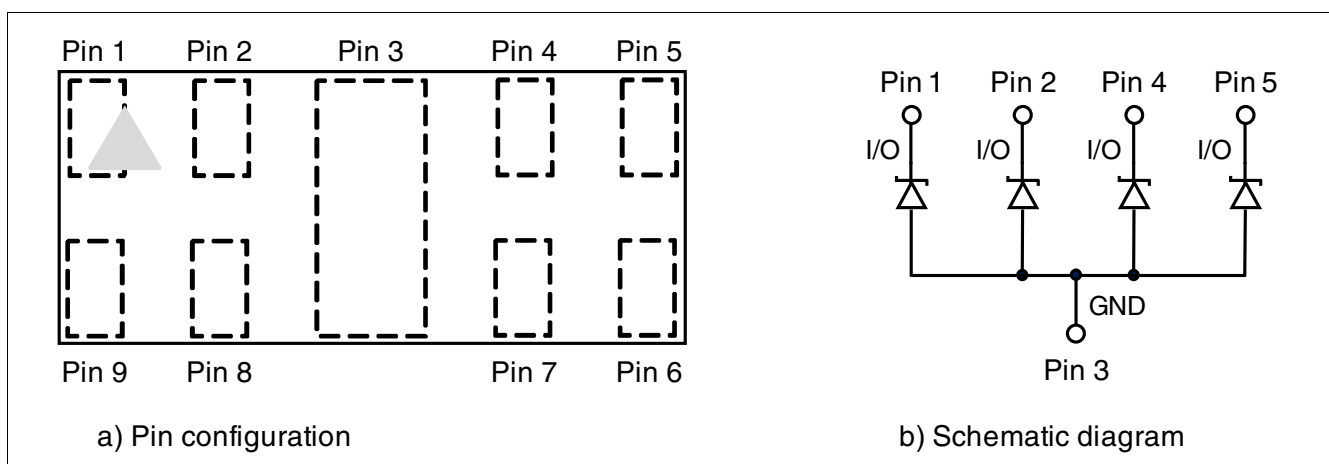

Figure 1 a) Pin Configuration and b) Schematic Diagram

Table 1 Ordering information

Type	Package	Configuration	Marking code
ESD3V3U4ULC	PG-TSLP-9-1	4 lines, uni-directional	Z2

3 Characteristics

Table 2 Maximum Rating at $T_A = 25\text{ }^\circ\text{C}$, unless otherwise specified

Parameter	Symbol	Values			Unit
		Min.	Typ.	Max.	
ESD contact discharge ¹⁾	V_{ESD}	-20	–	20	kV
Peak pulse current ($t_p = 8/20\ \mu\text{s}$) ²⁾	I_{PP}	-3	–	3	A
Operating temperature	T_{OP}	-40	–	125	$^\circ\text{C}$
Storage temperature	T_{stg}	-65	–	150	$^\circ\text{C}$

1) V_{ESD} according to IEC61000-4-2

2) I_{PP} according to IEC61000-4-5

3.1 Electrical Characteristics at $T_A = 25\text{ }^\circ\text{C}$, unless otherwise specified

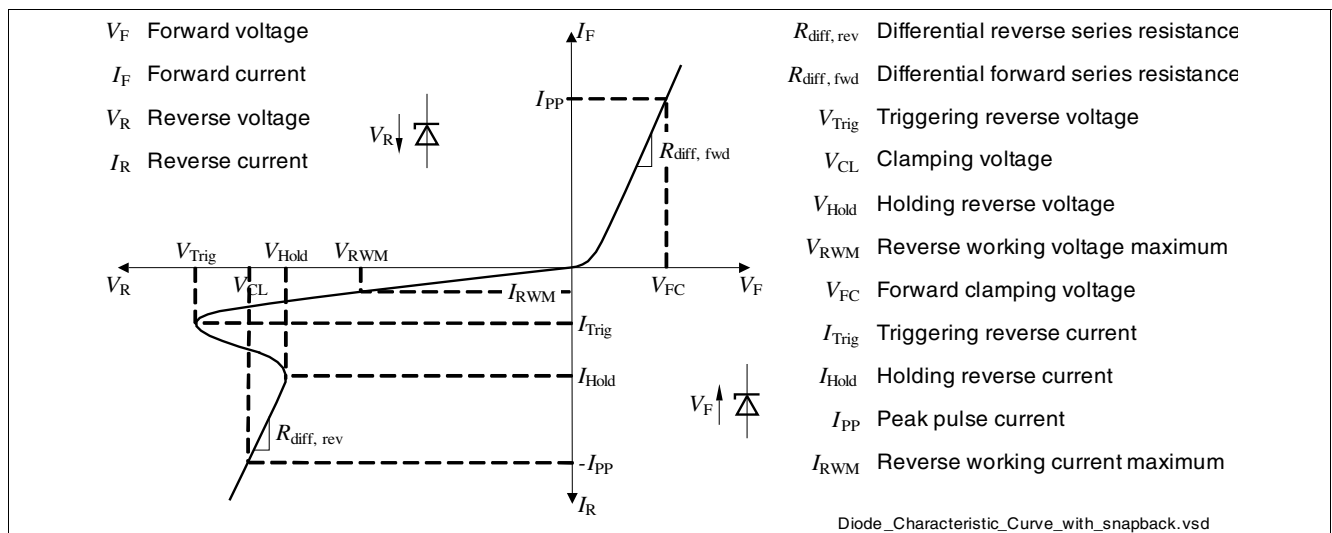

Figure 2 Definitions of electrical characteristics[1]

Table 3 DC characteristics at $T_A = 25\text{ }^\circ\text{C}$, unless otherwise specified

Parameter	Symbol	Values			Unit	Note / Test Condition
		Min.	Typ.	Max.		
Reverse working voltage	V_{RWM}	–	–	3.3	V	I/O to GND
Reverse current	I_R	–	1	50	nA	$V_R = 3.3\text{ V}$, I/O to GND

Table 4 RF characteristics at $T_A = 25\text{ °C}$, unless otherwise specified

Parameter	Symbol	Values			Unit	Note / Test Condition
		Min.	Typ.	Max.		
Line capacitance	C_L	–	0.4	0.65	pF	$V_R = 0\text{ V}$, $f = 1\text{ MHz}$, I/O to GND
		–	0.2	0.35	pF	$V_R = 0\text{ V}$, $f = 1\text{ MHz}$, I/O to I/O

Table 5 ESD characteristics at $T_A = 25\text{ °C}$, unless otherwise specified

Parameter	Symbol	Values			Unit	Note / Test Condition
		Min.	Typ.	Max.		
Reverse clamping voltage ¹⁾ [2]	V_{CL}	–	9	–	V	$I_{PP} = 16\text{ A}$
		–	12	–	V	$I_{PP} = 30\text{ A}$
Forward clamping voltage ¹⁾ [2]	V_{FC}	–	6	–	V	$I_{PP} = 16\text{ A}$
		–	10	–	V	$I_{PP} = 30\text{ A}$
Reverse dynamic resistance ¹⁾ [2]	$R_{dyn, rev}$	–	0.2	–	Ω	
Forward dynamic resistance ¹⁾ [2]	$R_{dyn, fwd}$	–	0.25	–	Ω	

1) Please refer to Application Note AN210. TLP parameter: $Z_0 = 50\ \Omega$, $t_p = 100\text{ ns}$, $t_r = 300\text{ ps}$, averaging window: $t_1 = 30\text{ ns}$ to $t_2 = 60\text{ ns}$, extraction of dynamic resistance using least squares fit of TLP characteristic between $I_{PP1} = 10\text{ A}$ and $I_{PP2} = 40\text{ A}$.

3.2 Typical Performance characteristics at $T_A = 25\text{ }^\circ\text{C}$, unless otherwise specified

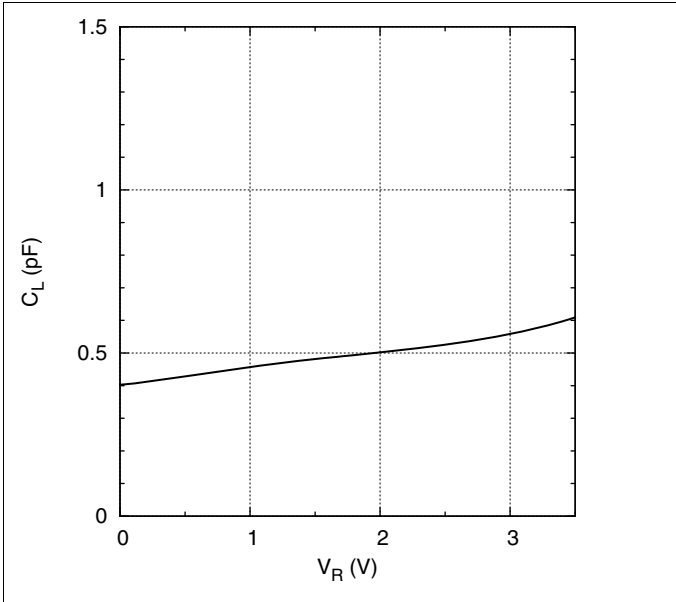

Figure 3 Line capacitance $C_L = f(V_R)$

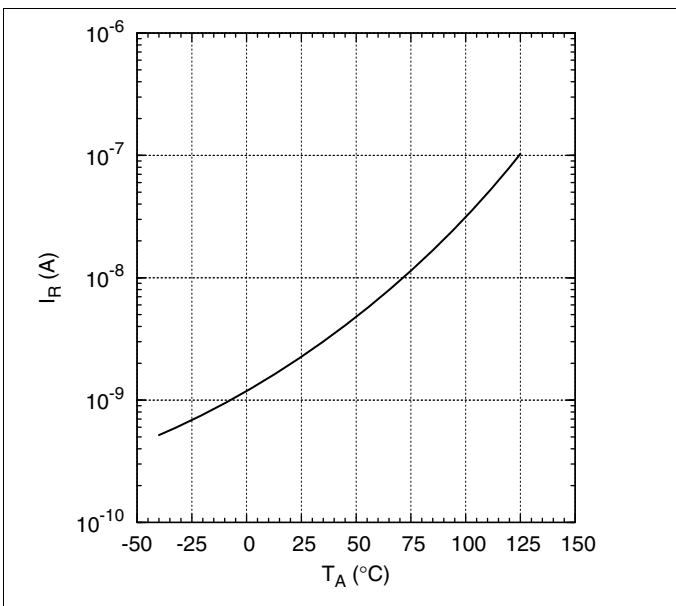

Figure 4 Reverse current $I_R = f(T_A)$, $V_R = 3.3\text{ V}$

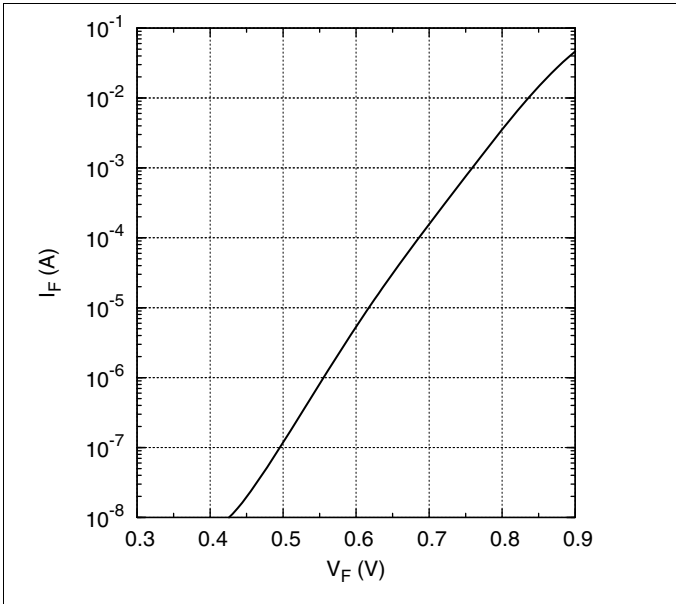

Figure 5 Forward characteristic, $I_F = f(V_F)$, current forced

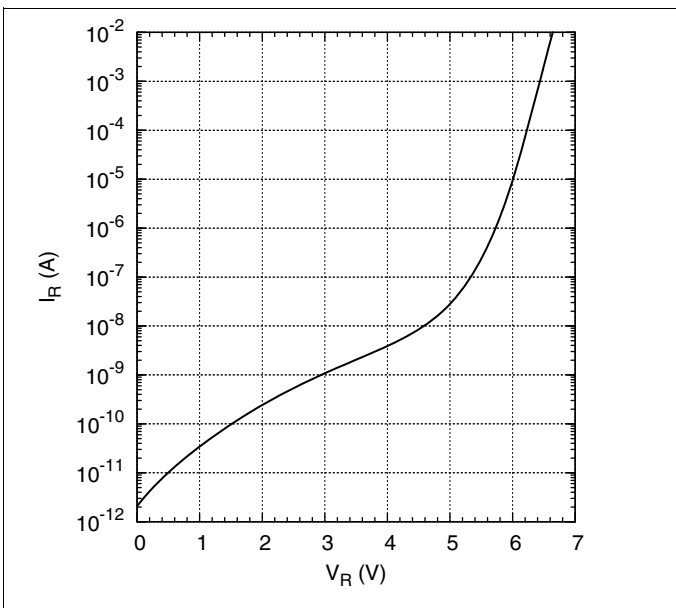

Figure 6 Reverse characteristic, $I_R = f(V_R)$, voltage forced

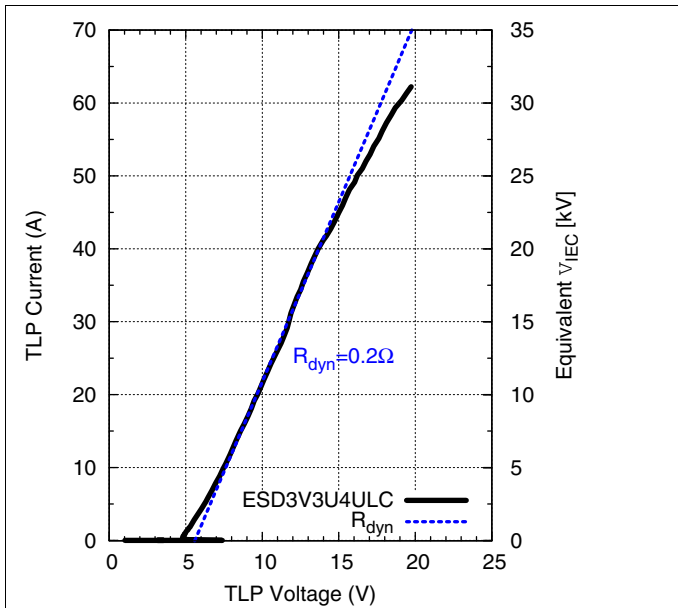

Figure 7 Reverse TLP characteristic ^{Note: [2]}

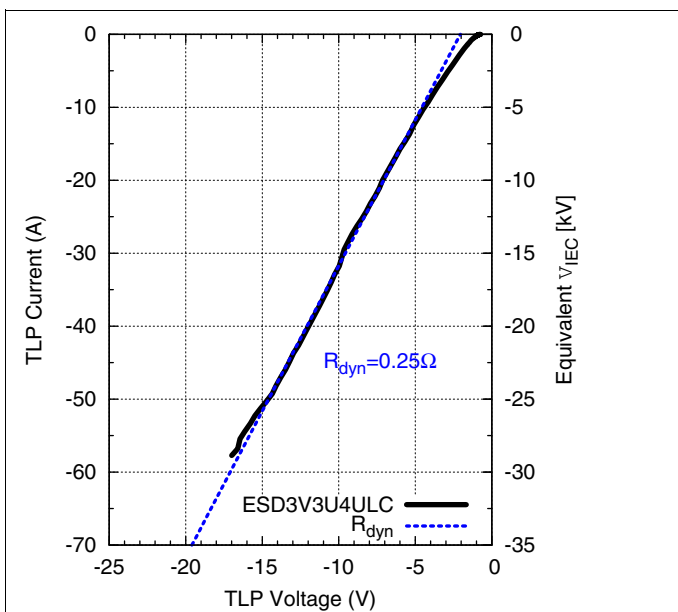

Figure 8 Forward TLP characteristic ^{Note: [2]}

Note: TLP parameter: $Z_0 = 50 \Omega$, $t_p = 100 \text{ ns}$, $t_r = 300 \text{ ps}$, averaging window: $t_1 = 30 \text{ ns}$ to $t_2 = 60 \text{ ns}$, extraction of dynamic resistance using least squares fit of TLP characteristic between $I_{PP1} = 10 \text{ A}$ and $I_{PP2} = 40 \text{ A}$. The equivalent stress level V_{IEC} according IEC 61000-4-2 ($R = 330 \Omega$, $C = 150 \text{ pF}$) is calculated at the broad peak of the IEC waveform at $t = 30 \text{ ns}$ with $2 \text{ A} / \text{kV}$

4 Application Information

To design USB3.0 link for best system level ESD performance and error free Signal Integrity is mandatory.

To bring both requirements together, the ESD protection devices has to provide excellent ESD and a very low device capacitance. The Infineon ESD3V3U4ULC in “array” configuration, combined with a clear and straight forward “full through” layout fulfills these requirements in the best way.

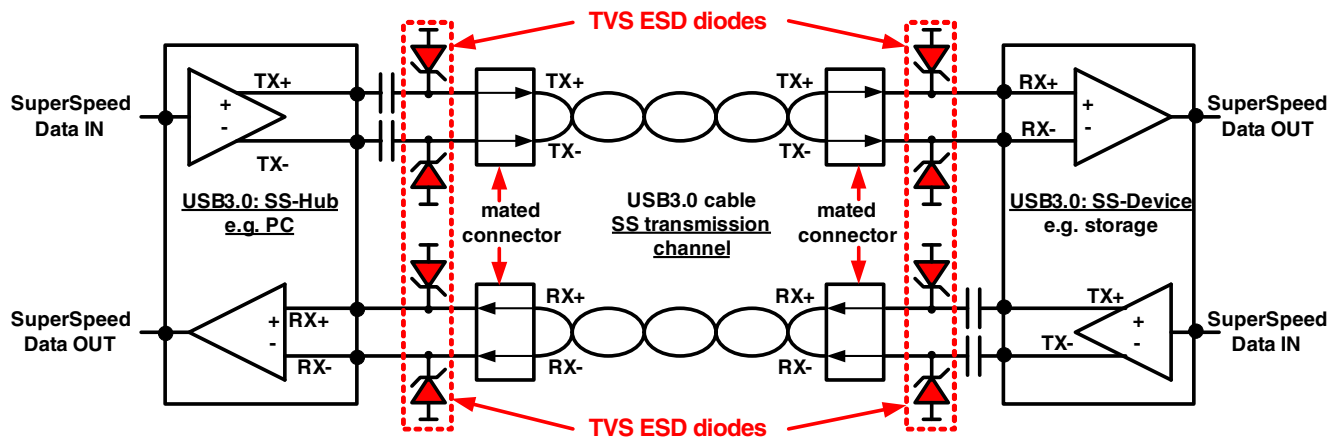

Figure 9 USB3.0 structure with ESD protection devices [3]

5 Ordering information scheme

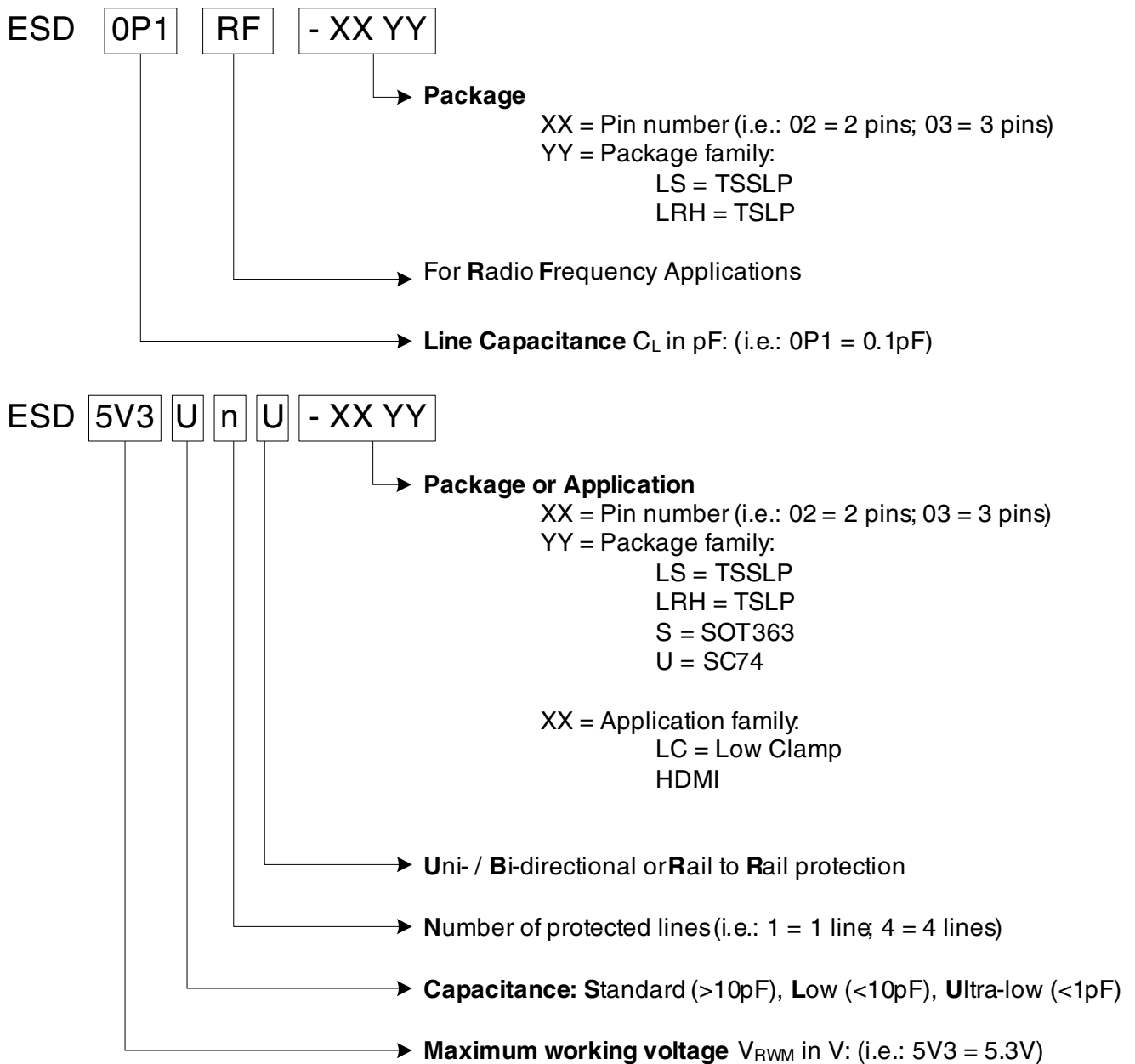

Figure 10 Ordering Information Scheme

6 Package Information

6.1 PG-TSLP-9-1

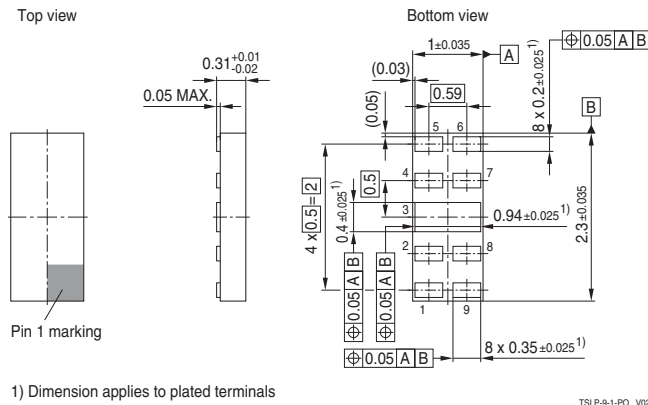

Figure 11 PG-TSLP-9-1: Package Overview

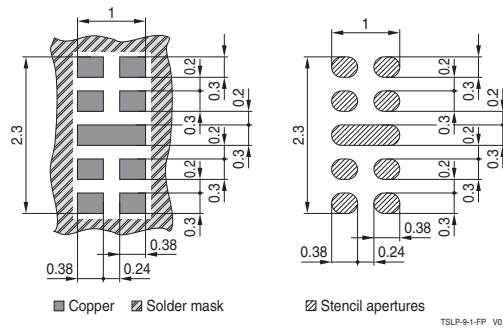

Figure 12 PG-TSLP-9-1: Footprint

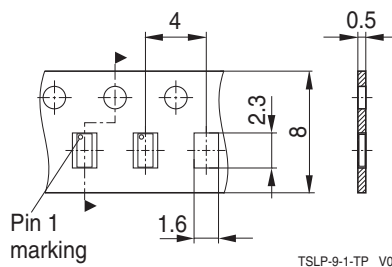

Figure 13 PG-TSLP-9-1: Packing

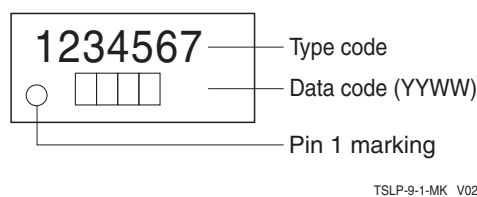

Figure 14 PG-TSLP-9-1: Marking

References

- [1] **On-chip ESD protection for integrated circuits**, Albert Z. H. Wang, ISBN:0-7923-7647-1
- [2] Infineon Technologie AG - **Application Note AN210**: Effective ESD Protection Design at System Level Using VF-TLP Characterization Methodology
- [3] Infineon Technologie AG - **Application Note AN240**: Effective ESD Protection for USB3.0, combined with perfect Signal Integrity.

Terminology

C_L	Line capacitance
DSC	Digital Still Camera
DVD	Digital Versatile Disc
DVI	Digital Visual Interface
EFT	Electrical Fast Transient
ESD	Electrostatic Discharge
HDMI	High Definition Multimedia Interface
IEC	International Electrotechnical Commission
I_{PP}	Peak pulse current
I_R	Reverse current
I_{RWM}	Reverse working current maximum
LCD	Liquid Crystal Display
MP3	Moving Picture Experts Group III
PCB	Printed Circuit Board
$R_{dyn, fwd}$	Forward dynamic resistance
$R_{dyn, rev}$	Reverse dynamic resistance
RoHS	Restriction of Hazardous Substances Directive
S-ATA	Serial Advanced Technology Attachment
STB	Set-Top-Box
T_A	Ambient temperature
TLP	Transmission Line Pulse
T_{OP}	Operation temperature
t_p	Pulse duration
t_r	Pulse rise time
T_{stg}	Storage temperature
USB	Universal Serial Bus
V_{CL}	Reverse clamping voltage
V_{ESD}	Electrostatic discharge voltage
V_{FC}	Forward Clamping Voltage
V_{Hold}	Holding Voltage
V_{IEC}	Equivalent stress level according IEC61000-4-2 ($R = 330 \Omega$, $C = 150 \text{ pF}$)
V_R	Reverse voltage
V_{RWM}	Reverse working voltage maximum
V_{Trig}	Triggering Voltage
Z_0	Impedance

www.infineon.com

Published by Infineon Technologies AG