

# LM21212-1

## 12A High Efficiency Synchronous Buck Regulator with Frequency Synchronization

### General Description

The LM21212-1 is a monolithic synchronous buck regulator that is capable of delivering up to 12A of continuous output current while producing an output voltage down to 0.6V with outstanding efficiency. The device is optimized to work over an input voltage range of 2.95V to 5.5V, making it suited for a wide variety of low voltage systems. The voltage mode control loop provides high noise immunity, narrow duty cycle capability and can be compensated to be stable with any type of output capacitance, providing maximum flexibility and ease of use.

The LM21212-1 features internal over voltage protection (OVP) and over-current protection (OCP) for increased system reliability. A precision enable pin and integrated UVLO allow turn-on of the device to be tightly controlled and sequenced. Startup inrush currents are limited by both an internally fixed and externally adjustable soft-start circuit. Fault detection and supply sequencing are possible with the integrated power good circuit.

The LM21212-1 is designed to work well in multi-rail power supply architectures. The output voltage of the device can be configured to track an external voltage rail using the SS/TRK pin. The switching frequency can be synchronized to the falling edge of a clock between the frequencies of 300kHz to 1.5MHz

If the output is pre-biased at startup, it will not sink current, allowing the output to smoothly rise past the pre-biased voltage. The regulator is offered in a 20-pin eTSSOP package with an exposed pad that can be soldered to the PCB, eliminating the need for bulky heatsinks.

### Features

- Integrated 7.0 mΩ high side and 4.3 mΩ low side FET switches
- 300 kHz to 1.5 MHz frequency SYNC pin
- Adjustable output voltage from 0.6V to  $V_{IN}$  (100% duty cycle capable),  $\pm 1\%$  reference
- Input voltage range 2.95V to 5.5V
- Startup into pre-biased loads
- Output voltage tracking capability
- Wide bandwidth voltage loop error amplifier
- Adjustable soft-start with external capacitor
- Precision enable pin with hysteresis
- Integrated OVP, OCP, OTP, UVLO and Power-Good
- Thermally Enhanced eTSSOP-20 exposed pad package

### Applications

- Broadband, networking and wireless communications
- High-performance FPGAs, ASICs and microprocessors
- Simple to design, high efficiency point of load regulation from a 5V or 3.3V bus

### Simplified Application Circuit

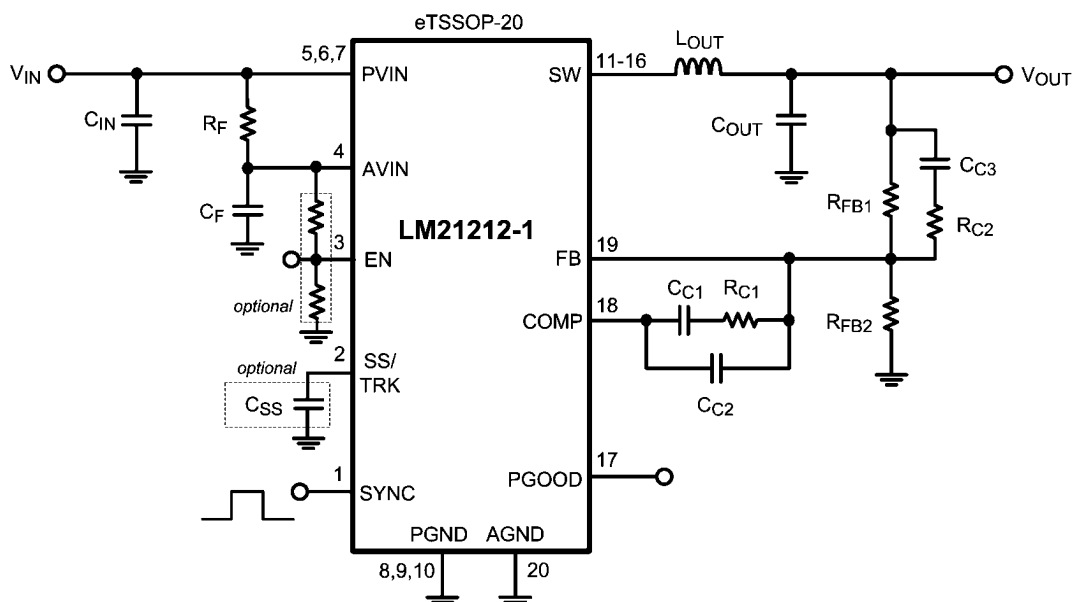

## Connection Diagram

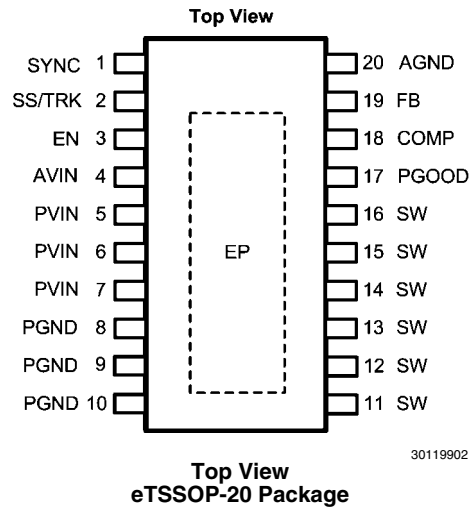

## Ordering Information

Order Number	Package Type	NSC Package Drawing	Package Marking	Supplied As
LM21212MH-1	eTSSOP-20	MYB20A	LM21212MH-1	73 Units per Rail
LM21212MHX-1	eTSSOP-20	MYB20A	LM21212MH-1	2500 Units Per Reel
LM21212MHE-1	eTSSOP-20	MYB20A	LM21212MH-1	250 Units Per Reel

## Pin Descriptions

Pins	Name	Description
1	SYNC	Frequency Synchronization input pin. Applying a clock signal to this pin will force the device to switch at the clock frequency. If left unconnected, the frequency will default to 1 MHz.
2	SS/TRK	Soft-start control pin. An internal 2 $\mu$ A current source charges an external capacitor connected between this pin and AGND to set the output voltage ramp rate during startup. This pin can also be used to configure the tracking feature.
3	EN	Active high enable input for the device. If not used, the EN pin can be left open, which will go high due to an internal current source.
4	AVIN	Analog input voltage supply that generates the internal bias. It is recommended to connect PVIN to AVIN through a low pass RC filter to minimize the influence of input rail ripple and noise on the analog control circuitry.
5,6,7	PVIN	Input voltage to the power switches inside the device. These pins should be connected together at the device. A low ESR input capacitance should be located as close as possible to these pins.
8,9,10	PGND	Power ground pins for the internal power switches.
11-16	SW	Switch node pins. These pins should be tied together locally and connected to the filter inductor.
17	PGOOD	Open-drain power good indicator.
18	COMP	Compensation pin is connected to the output of the voltage loop error amplifier.
19	FB	Feedback pin is connected to the inverting input of the voltage loop error amplifier.
20	AGND	Quiet analog ground for the internal reference and bias circuitry.
EP	Exposed Pad	Exposed metal pad on the underside of the package with an electrical and thermal connection to PGND. It is recommended to connect this pad to the PC board ground plane in order to improve thermal dissipation.

## Absolute Maximum Ratings (Note 1)

If Military/Aerospace specified devices are required, please contact the National Semiconductor Sales Office/Distributors for availability and specifications.

PVIN <small>(Note 2)</small> , AVIN to GND	-0.3V to +6V
SW <small>(Note 3)</small> , EN, FB, COMP, PGOOD, SS/TRK to GND	-0.3V to PVIN + 0.3V
Storage Temperature	-65°C to 150°C
Lead Temperature (Soldering, 10 sec.)	260°C

ESD Rating

Human Body Model (Note 4)

2kV

## Operating Ratings (Note 1)

PVIN, AVIN to GND	+2.95V to +5.5V
Junction Temperature	-40°C to +125°C
$\theta_{JA}$ <small>(Note 5)</small>	24°C/W

**Electrical Characteristics** Unless otherwise stated, the following conditions apply:  $V_{PVIN, AVIN} = 5V$ . Limits in standard type are for  $T_J = 25^\circ C$  only, limits in **bold face type** apply over the junction temperature ( $T_J$ ) range of  $-40^\circ C$  to  $+125^\circ C$ . Minimum and maximum limits are guaranteed through test, design, or statistical correlation. Typical values represent the most likely parametric norm at  $T_J = 25^\circ C$ , and are provided for reference purposes only.

Symbol	Parameter	Conditions	Min	Typ	Max	Units
<b>SYSTEM</b>						
$V_{FB}$	Feedback pin voltage	$V_{IN} = 2.95V$ to $5.5V$	<b>-1%</b>	0.6	<b>1%</b>	V
$\Delta V_{OUT}/\Delta I_{OUT}$	Load Regulation			0.02		% $V_{OUT}/A$
$\Delta V_{OUT}/\Delta V_{IN}$	Line Regulation			0.1		% $V_{OUT}/V$
$R_{DSON HS}$	High Side Switch On Resistance	$I_{SW} = 12A$		7	<b>9.0</b>	m $\Omega$
$R_{DSON LS}$	Low Side Switch On Resistance	$I_{SW} = 12A$		4.3	<b>6.0</b>	m $\Omega$
$I_{CLR}$	HS Rising Switch Current Limit		<b>15</b>	17	<b>19</b>	A
$I_{CLF}$	LS Falling Switch Current Limit			12		A
$V_{ZX}$	Zero Cross Voltage		-8	3	12	mV
$I_Q$	Operating Quiescent Current			1.5	<b>3</b>	mA
$I_{SD}$	Shutdown Quiescent Current	$V_{EN} = 0V$		50	<b>70</b>	$\mu A$
$V_{UVLO}$	AVIN Under Voltage Lockout	AVIN Rising	<b>2.45</b>	2.7	<b>2.95</b>	V
$V_{UVLOHYS}$	AVIN Under Voltage Lockout Hysteresis		<b>140</b>	200	<b>280</b>	mV
$V_{TRACKOS}$	SS/TRACK PIN accuracy ( $V_{SS} - V_{FB}$ )	$0 < V_{TRACK} < 0.55V$	<b>-10</b>	6	<b>20</b>	mV
$I_{SS}$	Soft-Start Pin Source Current		<b>1.3</b>	1.9	<b>2.5</b>	$\mu A$
$t_{INTSS}$	Internal Soft-Start Ramp to Vref	$C_{SS} = 0$	<b>350</b>	500	<b>675</b>	$\mu s$
$t_{RESETSS}$	Device reset to soft-start ramp		<b>50</b>	110	<b>200</b>	$\mu s$
<b>OSCILLATOR</b>						
$f_{SYNCR}$	SYNC Frequency Range		<b>300</b>		<b>1500</b>	kHz
$f_{DEFAULT}$	Default (no SYNC signal) Frequency		<b>950</b>	1000	<b>1050</b>	kHz
$t_{SY\_SW}$	Time from SYNC falling to $V_{SW}$ Rising			200		ns
$t_{SY\_MIN}$	Minimum SYNC pin pulse width, high or low			100		ns
$t_{HSBLANK}$	HS OCP blanking time	Rising edge of SW to $I_{CLR}$ comparison		55		ns
$t_{LSBLANK}$	LS OCP blanking time	Falling edge of SW to $I_{CLF}$ comparison		400		ns
$t_{ZXBLANK}$	Zero Cross blanking time	Falling edge of SW to $V_{ZX}$ comparison		120		ns
$t_{MINON}$	Minimum HS on-time			140		ns
$\Delta V_{ramp}$	PWM Ramp p-p Voltage			0.8		V
<b>ERROR AMPLIFIER</b>						
$V_{OL}$	Error Amplifier Open Loop Voltage Gain	ICOMP = $-65\mu A$ to $1mA$		95		dBV/V
GBW	Error Amplifier Gain-Bandwidth Product			11		MHz
$I_{FB}$	Feedback Pin Bias Current	$V_{FB} = 0.6V$		1		nA

Symbol	Parameter	Conditions	Min	Typ	Max	Units
<b>SYSTEM</b>						
$I_{COMPSRC}$	COMP Output Source Current			1		mA
$I_{COMPSINK}$	COMP Output Sink Current			65		$\mu$ A
<b>POWERGOOD</b>						
$V_{OVP}$	Over Voltage Protection Rising Threshold	$V_{FB}$ Rising	<b>105</b>	112.5	<b>120</b>	$\%V_{FB}$
$V_{OVPHYS}$	Over Voltage Protection Hysteresis	$V_{FB}$ Falling		2		$\%V_{FB}$
$V_{UVP}$	Under Voltage Protection Rising Threshold	$V_{FB}$ Rising	<b>82</b>	90	<b>97</b>	$\%V_{FB}$
$V_{UVPHYS}$	Under Voltage Protection Hysteresis	$V_{FB}$ Falling		2.5		$\%V_{FB}$
$t_{PGDGL}$	PGOOD Deglitch Low (OVP/UVP Condition Duration to PGOOD Falling)			15		$\mu$ s
$t_{PGDGH}$	PGOOD Deglitch High (minimum low pulse)			12		$\mu$ s
$R_{PGOOD}$	PGOOD Pull-down Resistance		<b>10</b>	20	<b>40</b>	$\Omega$
$I_{PGOODLEAK}$	PGOOD Leakage Current	$V_{PGOOD} = 5V$		1		nA
<b>LOGIC</b>						
$V_{IHSYNC}$	SYNC Pin Logic High		2.0			V
$V_{ILSYNC}$	SYNC Pin Logic Low				0.8	V
$V_{IHENR}$	EN Pin Rising Threshold	$V_{EN}$ Rising	<b>1.20</b>	1.35	<b>1.45</b>	V
$V_{ENHYS}$	EN Pin Hysteresis		<b>50</b>	110	<b>180</b>	mV
$I_{EN}$	EN Pin Pullup Current	$V_{EN} = 0V$		2		$\mu$ A
<b>THERMAL SHUTDOWN</b>						
$T_{THERMSD}$	Thermal Shutdown			165		$^{\circ}$ C
$T_{THERMSDHYS}$	Thermal Shutdown Hysteresis			10		$^{\circ}$ C

**Note 1:** Absolute Maximum Ratings indicate limits beyond which damage to the device may occur. Operating Ratings indicate conditions for which the device is intended to be functional, but do not guarantee specific performance limits. For guaranteed specifications and test conditions, see the Electrical Characteristics.

**Note 2:** The PVIN pin can tolerate transient voltages up to 6.5 V for a period of up to 6ns. These transients can occur during the normal operation of the device.

**Note 3:** The SW pin can tolerate transient voltages up to 9.0 V for a period of up to 6ns, and -1.0V for a duration of 4ns. These transients can occur during the normal operation of the device.

**Note 4:** The human body model is a 100 pF capacitor discharged through a 1.5 k $\Omega$  resistor to each pin.

**Note 5:** Thermal measurements were performed on a 2x2 inch, 4 layer, 2 oz. copper outer layer, 1 oz. copper inner layer board with twelve 8 mil. vias underneath the EP of the device and an additional sixteen 8 mil. vias under the unexposed package.

**Typical Performance Characteristics** Unless otherwise specified:  $V_{VIN} = 5V$ ,  $V_{OUT} = 1.2V$ ,  $L = 0.56\mu H$  (1.8m $\Omega$   $R_{DCR}$ ),  $C_{SS} = 33nF$ ,  $f_{SW} = 1 MHz$ ,  $T_A = 25^{\circ}C$  for efficiency curves, loop gain plots and waveforms, and  $T_J = 25^{\circ}C$  for all others.

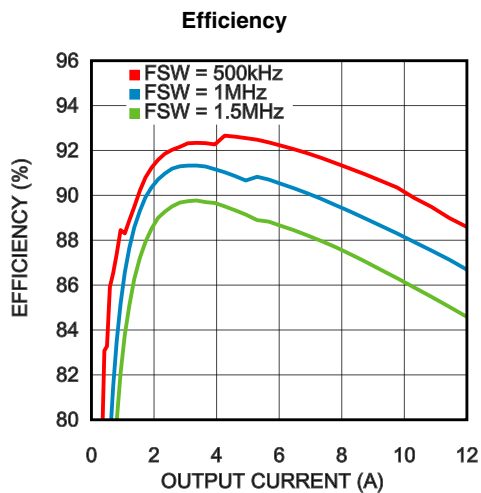

30119953

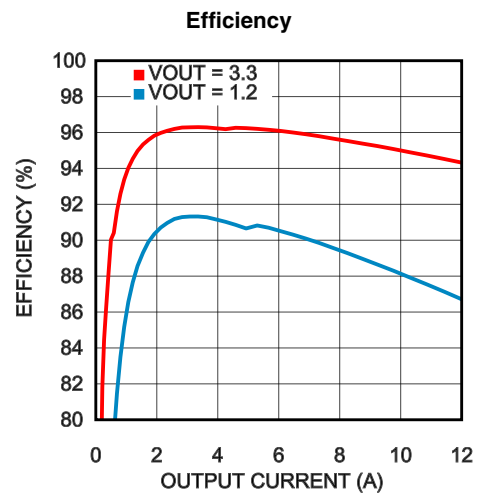

30119956

**Efficiency**  
( $V_{OUT} = 2.5\text{ V}$ ,  $f_{SW} = 300\text{ kHz}$ , Inductor P/N SER2010-102MLD)

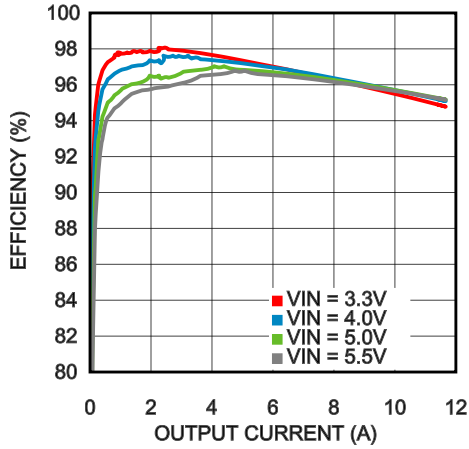

30119977

**Load Regulation**

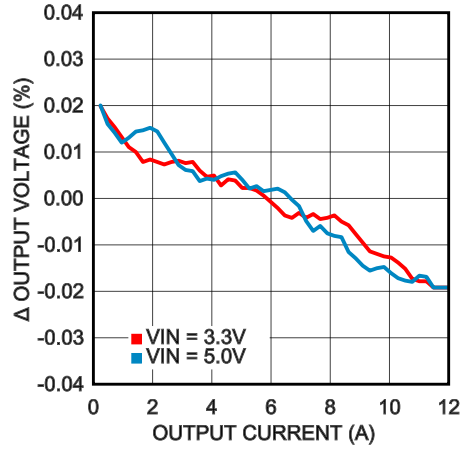

30119954

**Line Regulation**

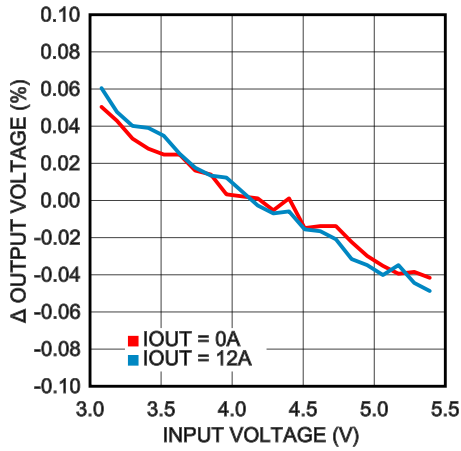

30119955

**Non-Switching  $I_{QTOTAL}$  vs.  $V_{IN}$**

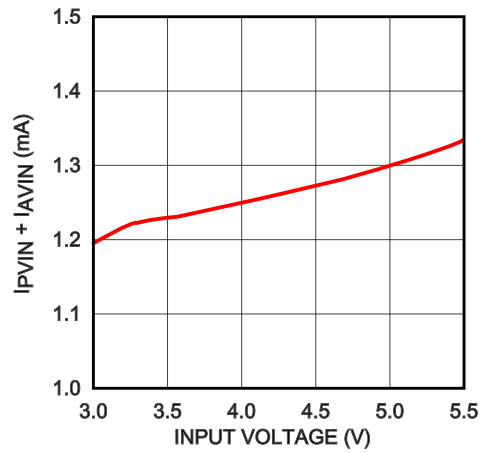

30119957

**Non-Switching  $I_{AVIN}$  and  $I_{PVIN}$  vs. Temperature**

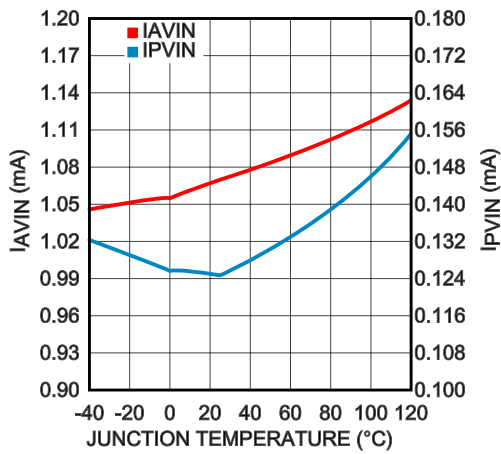

30119975

**$V_{FB}$  vs. Temperature**

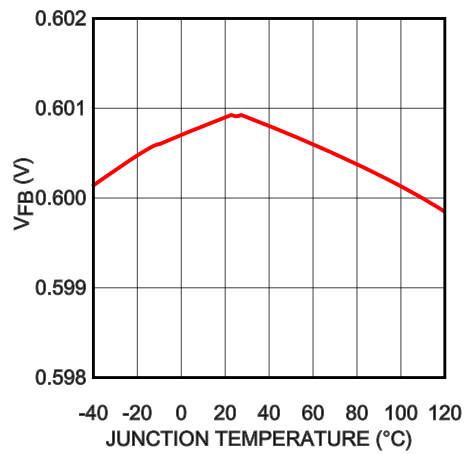

30119976

Enable Threshold and Hysteresis vs. Temperature

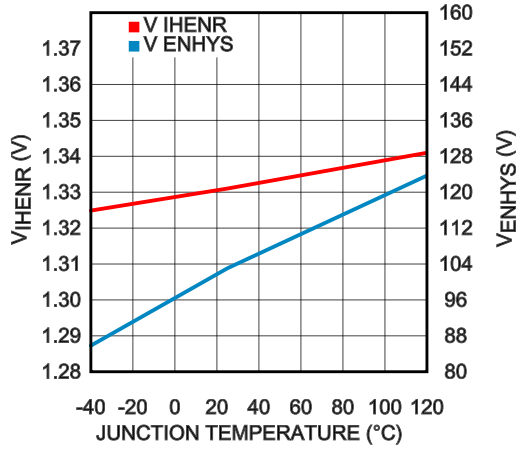

30119971

UVLO Threshold and Hysteresis vs. Temperature

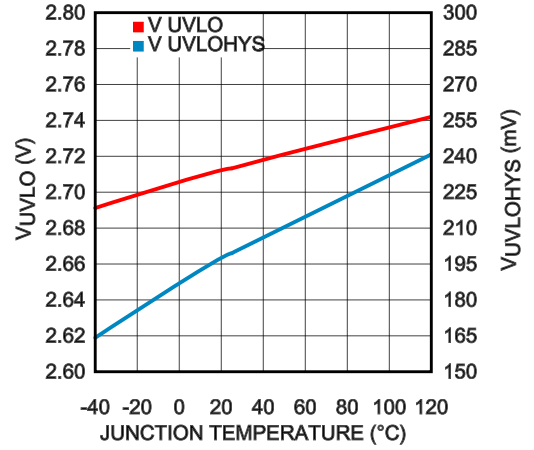

30119970

Enable Low Current vs. Temperature

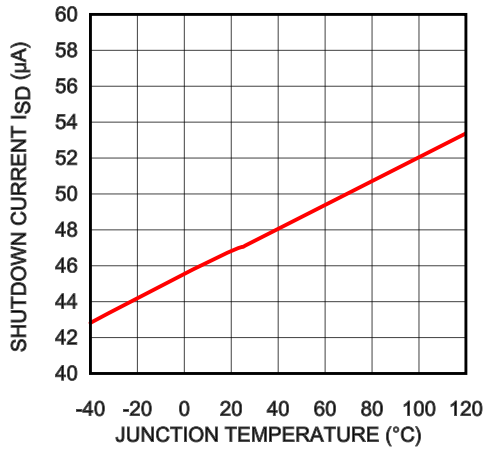

30119973

OVP/UVP Threshold vs. Temperature

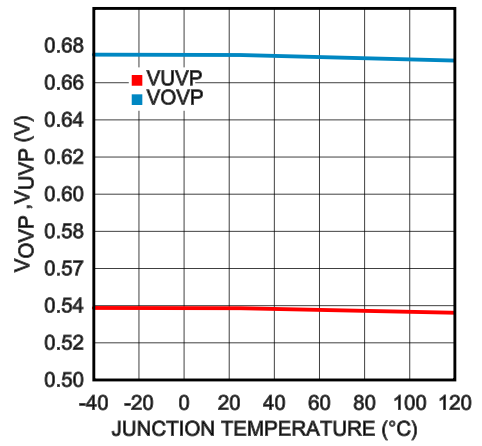

30119974

Minimum On-Time vs. Temperature

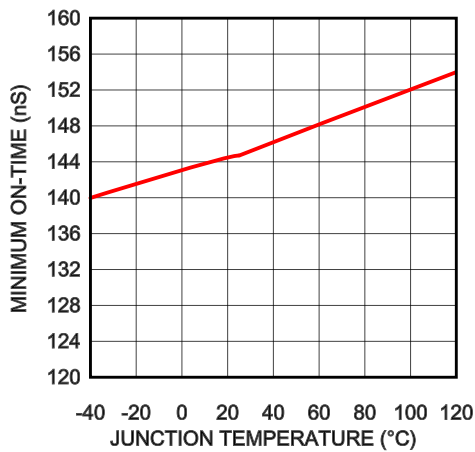

30119972

FET Resistance vs. Temperature

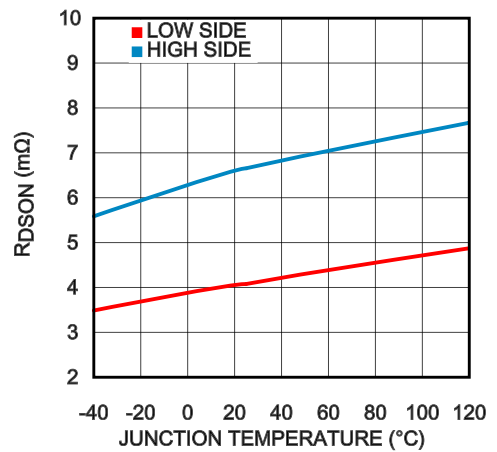

30119968

Peak Current Limit vs. Temperature

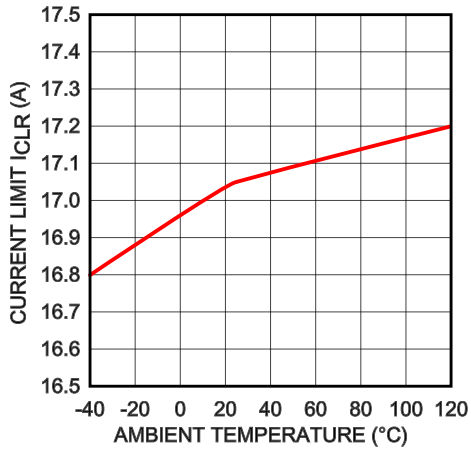

30119958

SYNC Signal Lost

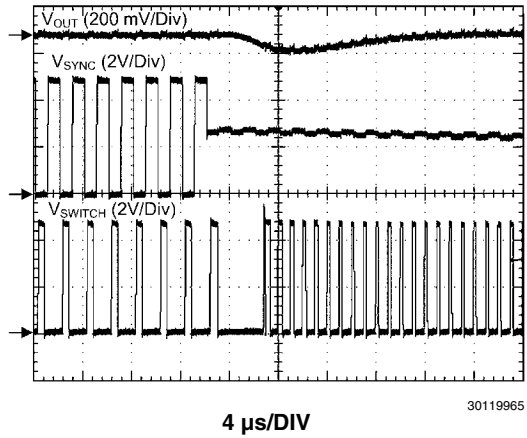

30119965

SYNC Signal Acquired

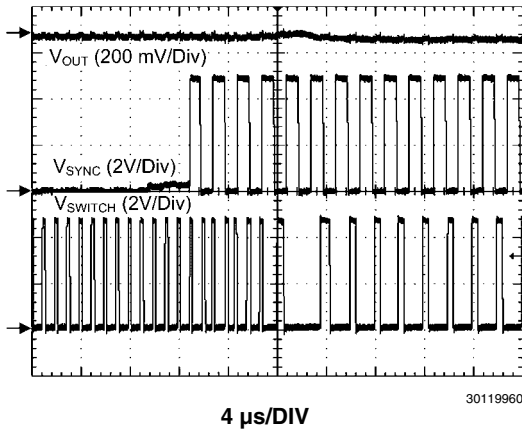

30119960

Load Transient Response

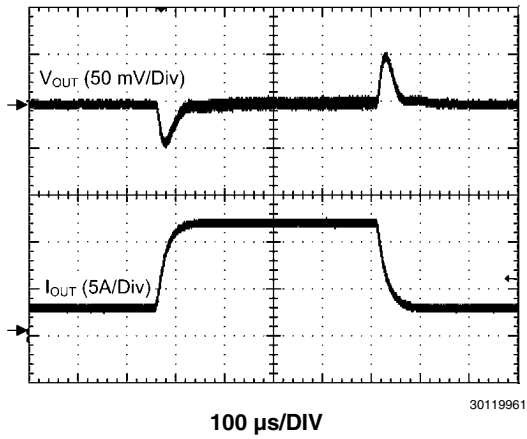

30119961

Output Voltage Ripple

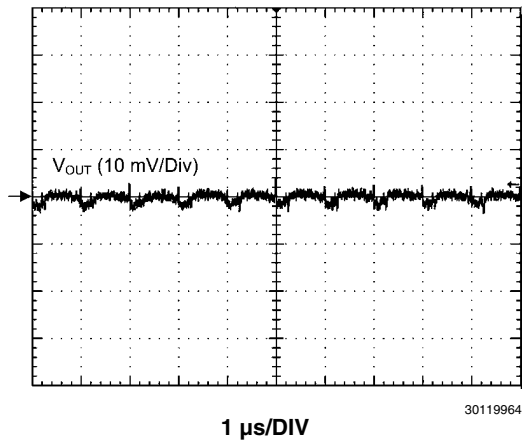

30119964

Startup with Prebiased Output

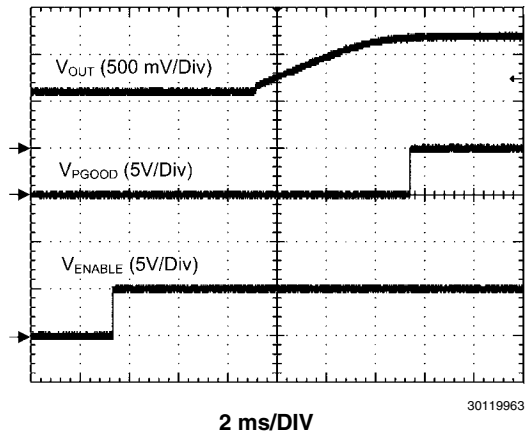

30119963

Startup with SS/TRK Open Circuit

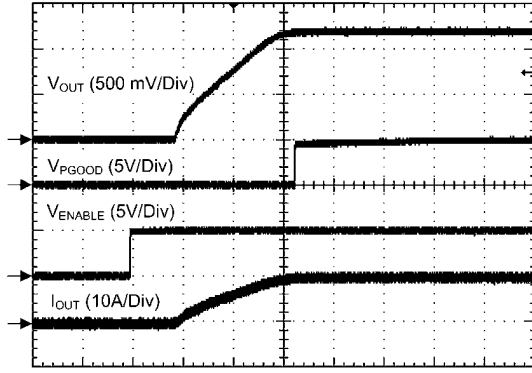

200  $\mu$ s/DIV

30119966

Startup with applied Track Signal

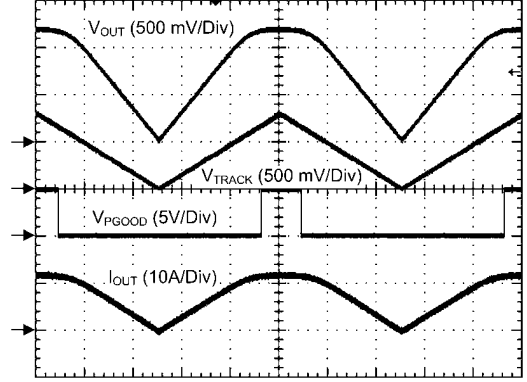

200 ms/DIV

30119967

Output Over-Current Condition

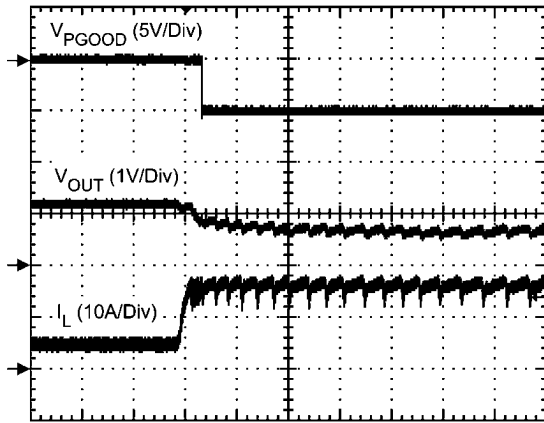

100  $\mu$ s/DIV

30119980



# Block Diagram

LM21212-1

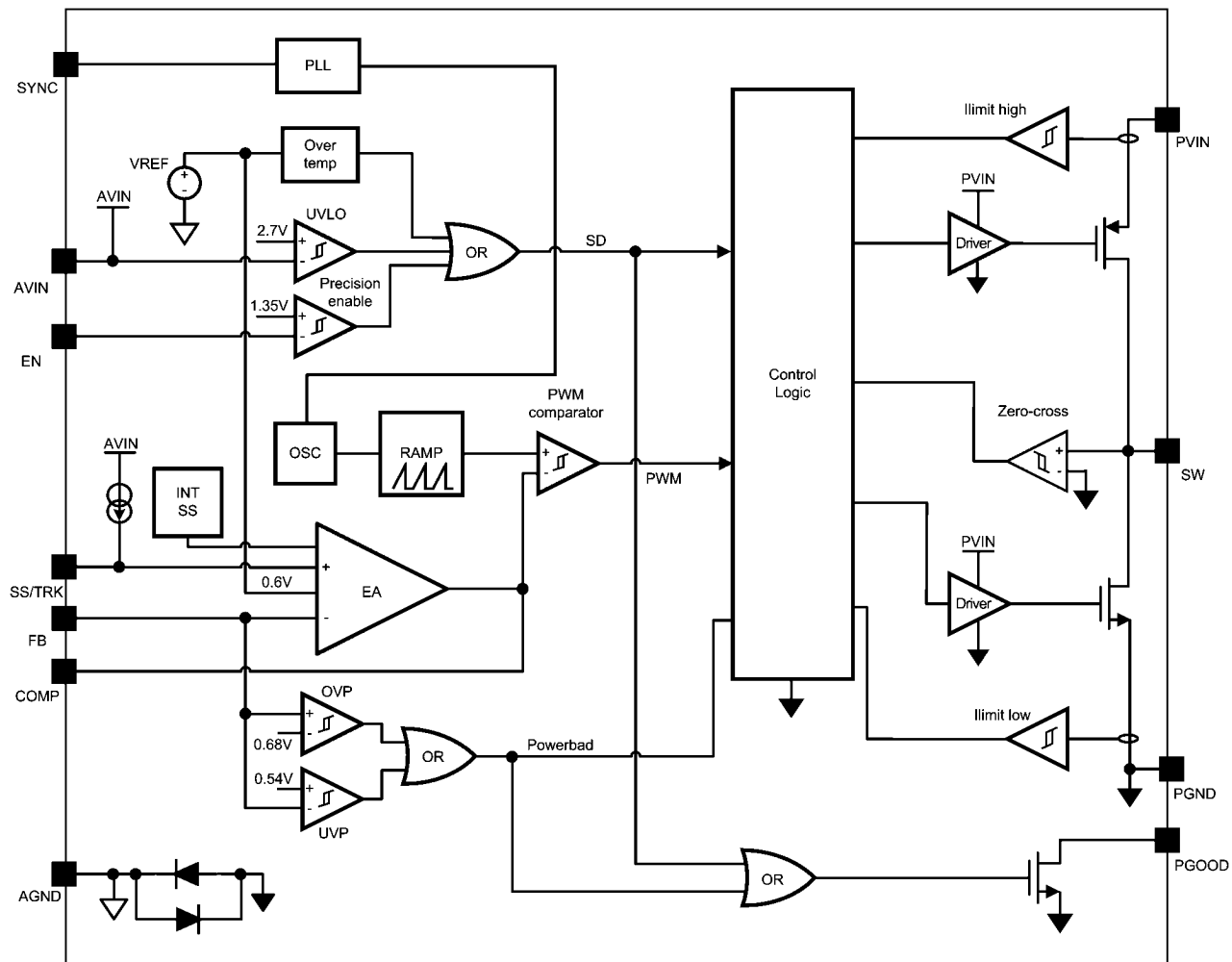

30119903

## Operation Description

### GENERAL

The LM21212-1 switching regulator features all of the functions necessary to implement an efficient low voltage buck regulator using a minimum number of external components. This easy to use regulator features two integrated switches and is capable of supplying up to 12A of continuous output current. The regulator utilizes voltage mode control with trailing edge modulation to optimize stability and transient response over the entire output voltage range. The device can operate at high switching frequency allowing use of a small inductor while still achieving high efficiency. The precision internal voltage reference allows the output to be set as low as 0.6V. Fault protection features include: current limiting, thermal shutdown, over voltage protection, and shutdown capability. The device is available in the eTSSOP-20 package featuring an exposed pad to aid thermal dissipation. The LM21212-1 can be used in numerous applications to efficiently step-down from a 5V or 3.3V bus.

### FREQUENCY SYNCHRONIZATION

The sync (SYNC) pin allows the LM21212-1 to be switched at an external clock frequency. When a clock signal is present on the SYNC pin within the allowable frequency range, 300 kHz to 1.5 MHz, the device will synchronize the turn-on of the high side FET (switch rising) to the negative edge of the clock signal, as seen in [Figure 1](#). If no clock signal is present, the LM21212-1 will default to a switching frequency of 1 MHz. The clock signal can be present on the SYNC pin before the device is powered on with no loading on the clock signal. Alternatively, if no clock is present while the device is powered up, it will begin switching at the default frequency of 1 MHz. Once the clock signal is present, the device will begin synchronizing to the clock frequency. The length of time necessary for the synchronization depends on the clock frequency.

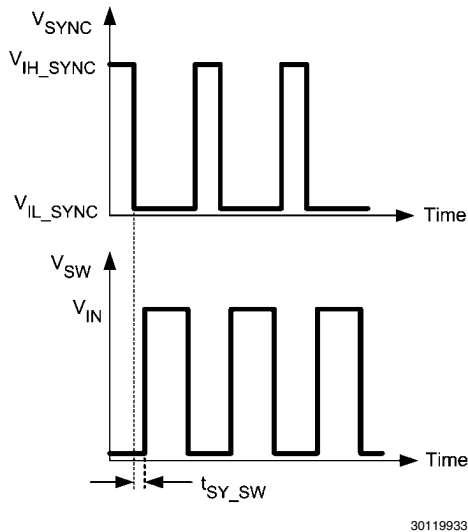

FIGURE 1. Frequency synchronization

### PRECISION ENABLE

The enable (EN) pin allows the output of the device to be enabled or disabled with an external control signal. This pin is a precision analog input that enables the device when the voltage exceeds 1.35V (typical). The EN pin has 110 mV of hysteresis and will disable the output when the enable voltage falls below 1.24V (typical). If the EN pin is not used, it can be left open, and will be pulled high by an internal 2  $\mu$ A current source. Since the enable pin has a precise turn-on threshold it can be used along with an external resistor divider network from VIN to configure the device to turn-on at a precise input voltage.

### UVLO

The LM21212-1 has a built-in under-voltage lockout protection circuit that keeps the device from switching until the input voltage reaches 2.7V (typical). The UVLO threshold has 200 mV of hysteresis that keeps the device from responding to power-on glitches during start up. If desired the turn-on point of the supply can be changed by using the precision enable pin and a resistor divider network connected to VIN as shown in [Figure 6](#) in the design guide.

### CURRENT LIMIT

The LM21212-1 has current limit protection to avoid dangerous current levels on the power FETs and inductor. A current limit condition is met when the current through the high side FET exceeds the rising current limit level ( $I_{CLR}$ ). The control circuitry will respond to this event by turning off the high side FET and turning on the low side FET. This forces a negative voltage on the inductor, thereby causing the inductor current to decrease. The high side FET will not conduct again until the lower current limit level ( $I_{CLF}$ ) is sensed on the low side FET. At this point, the device will resume normal switching.

A current limit condition will cause the internal soft-start voltage to ramp downward. After the internal soft-start ramps below the Feedback (FB) pin voltage, (nominally 0.6 V), FB will begin to ramp downward, as well. This voltage foldback will limit the power consumption in the device, thereby protecting the device from continuously supplying power to the load under a condition that does not fall within the device SOA. After the current limit condition is cleared, the internal soft-start voltage will ramp up again. [Figure 2](#) shows current limit behavior with  $V_{SS}$ ,  $V_{FB}$ ,  $V_{OUT}$  and  $V_{SW}$ .

## SHORT-CIRCUIT PROTECTION

In the unfortunate event that the output is shorted with a low impedance to ground, the LM21212-1 will limit the current into the short by resetting the device. A short-circuit condition is sensed by a current-limit condition coinciding with a voltage on the FB pin that is lower than 100 mV. When this condition occurs, the device will begin its reset sequence, turning off

both power FETs and discharging the soft-start capacitor after  $t_{\text{RESETSS}}$  (nominally 110  $\mu\text{s}$ ). The device will then attempt to restart. If the short-circuit condition still exists, it will reset again, and repeat until the short-circuit is cleared. The reset prevents excess current flowing through the FETs in a highly inefficient manner, potentially causing thermal damage to the device or the bus supply.

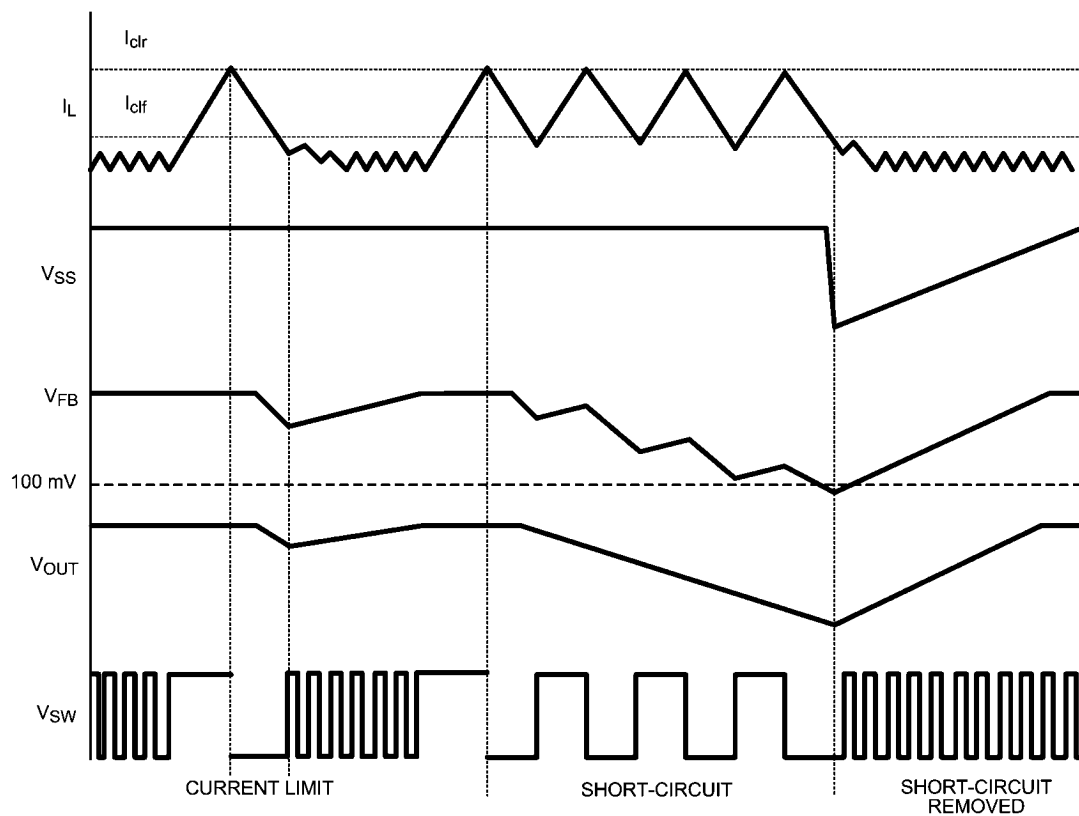

30119919

FIGURE 2. Current Limit Conditions

## THERMAL PROTECTION

Internal thermal shutdown circuitry is provided to protect the integrated circuit in the event that the maximum junction temperature is exceeded. When activated, typically at 165°C, the LM21212-1 tri-states the power FETs and resets soft start. After the junction cools to approximately 155°C, the device starts up using the normal start up routine. This feature is provided to prevent catastrophic failures from accidental device overheating. Note that thermal limit will not stop the die from operating above the specified absolute maximum temperature, 125°C. The die should be kept under 125°C to guarantee correct operation.

## POWERGOOD FLAG

The PGOOD pin provides the user with a way to monitor the status of the LM21212-1. In order to use the PGOOD pin, the application must provide a pull-up resistor to a desired DC voltage (i.e.  $V_{\text{in}}$ ). PGOOD will respond to a fault condition by pulling the PGOOD pin low with the open-drain output. Powergood will pull low on the following conditions – 1)  $V_{\text{FB}}$  moves above or below the  $V_{\text{OVP}}$  or  $V_{\text{UVP}}$ , respectively 2) The enable pin is brought below the enable threshold 3) The device enters a pre-biased output condition ( $V_{\text{FB}} > V_{\text{SS}}$ ).

Figure 3 shows the conditions that will cause PGOOD to fall.

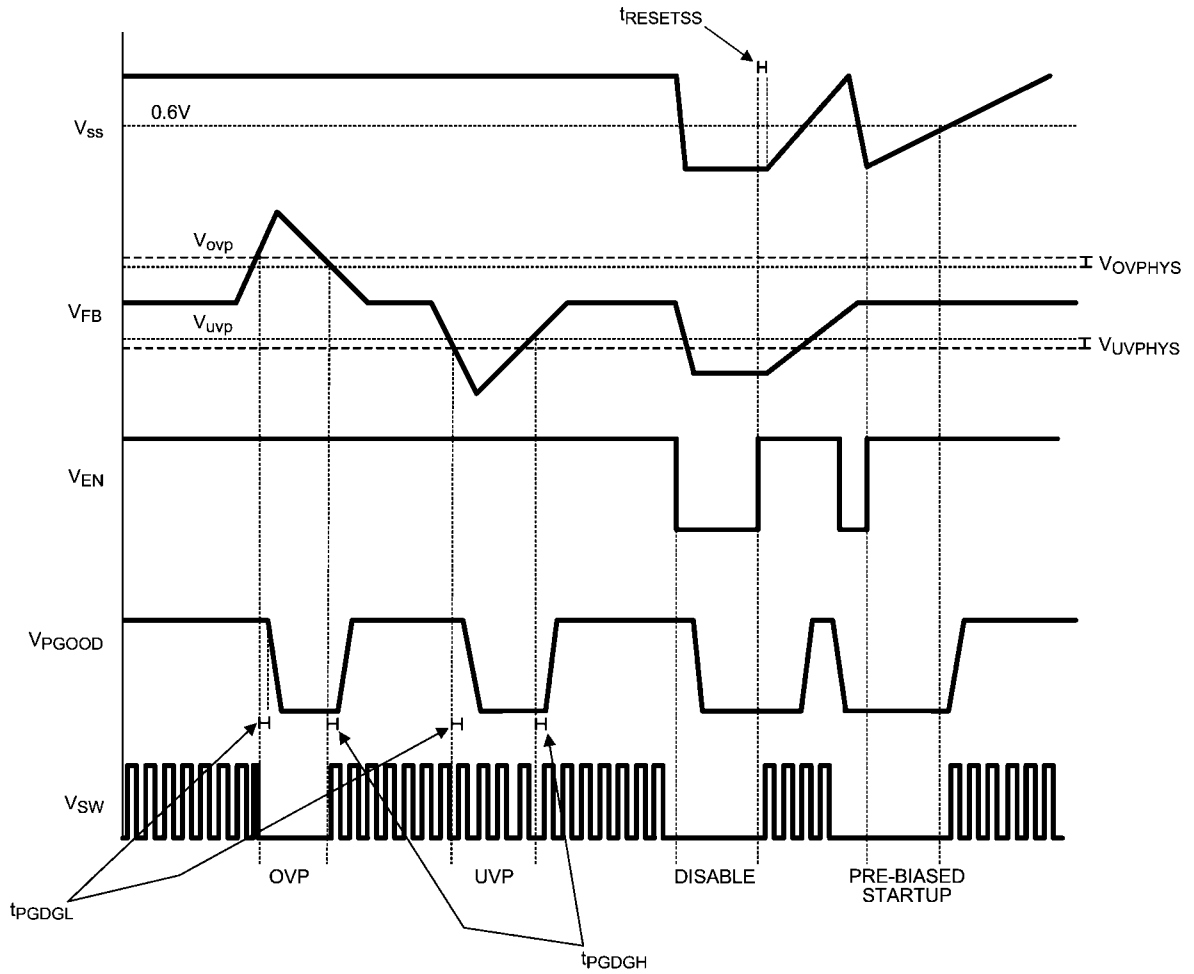

30119918

**FIGURE 3. PGOOD Conditions**

**LIGHT LOAD OPERATION**

The LM21212-1 offers increased efficiency when operating at light loads. Whenever the load current is reduced to a point where the peak to peak inductor ripple current is greater than two times the load current, the device will enter the diode emulation mode preventing significant negative inductor current. The point at which this occurs is the critical conduction boundary and can be calculated by the following equation:

$$I_{BOUNDARY} = \frac{(V_{IN} - V_{OUT}) \times D}{2 \times L \times f_{SW}}$$

Several diagrams are shown in [Figure 4](#) illustrating continuous conduction mode (CCM), discontinuous conduction mode (DCM), and the boundary condition.

It can be seen that in diode emulation mode, whenever the inductor current reaches zero the SW node will become high impedance. Ringing will occur on this pin as a result of the LC tank circuit formed by the inductor and the parasitic capacitance at the node. If this ringing is of concern an additional RC snubber circuit can be added from the switch node to ground.

At very light loads, usually below 100mA, several pulses may be skipped in between switching cycles, effectively reducing the switching frequency and further improving light-load efficiency.

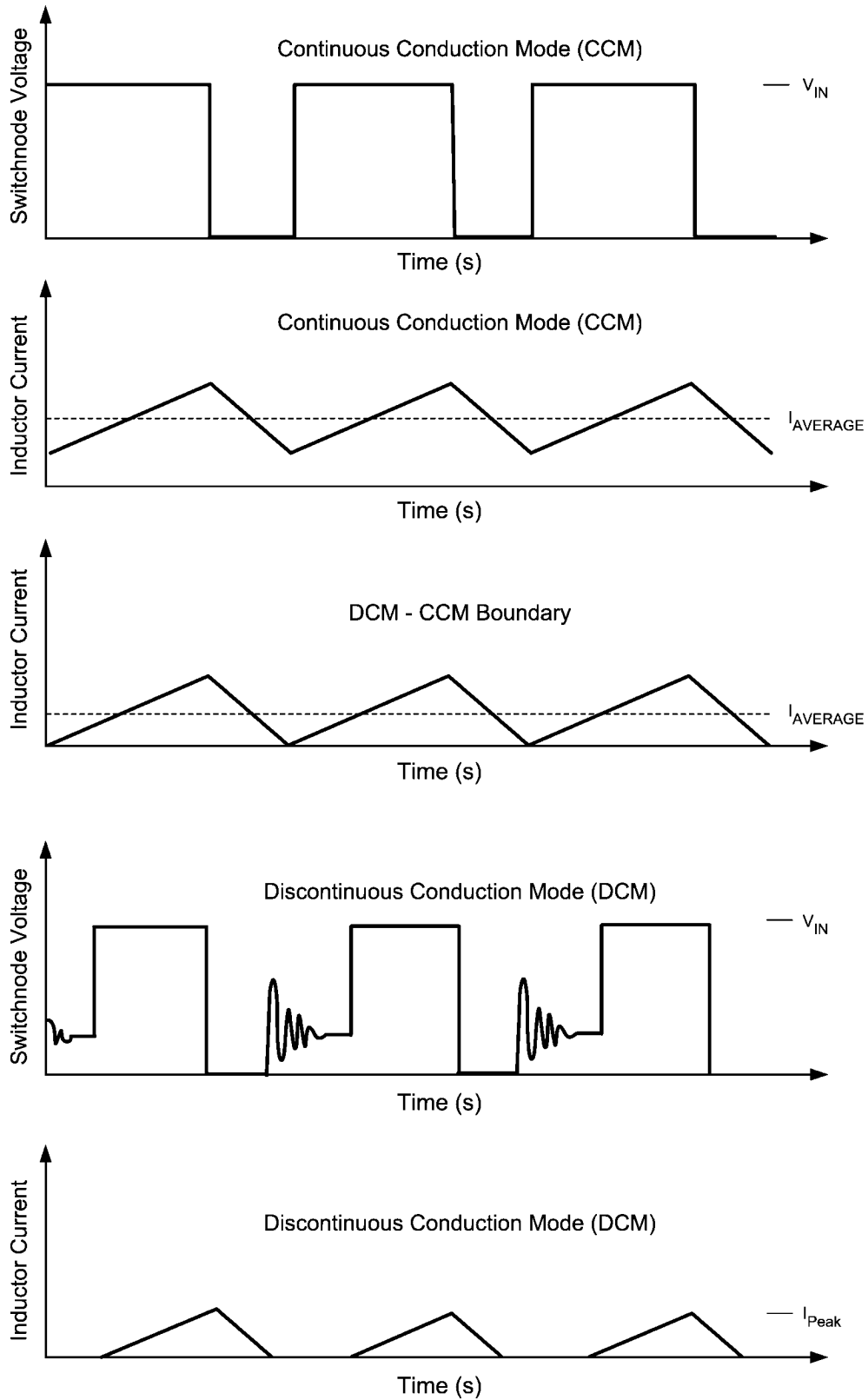

30119979

FIGURE 4. Modes of Operation for LM21212-1

## Design Guide

### OUTPUT VOLTAGE

The first step in designing the LM21212-1 application is setting the output voltage. This is done by using a voltage divider between  $V_{OUT}$  and AGND, with the middle node connected to  $V_{FB}$ . When operating under steady-state conditions, the LM21212-1 will force  $V_{OUT}$  such that  $V_{FB}$  is driven to 0.6 V.

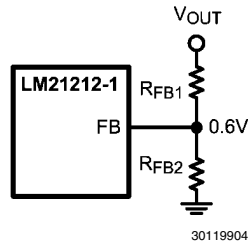

FIGURE 5. Setting  $V_{OUT}$

A good starting point for the lower feedback resistor,  $R_{FB2}$ , is 10k $\Omega$ .  $R_{FB1}$  can then be calculated the following equation:

$$V_{OUT} = \frac{R_{FB1} + R_{FB2}}{R_{FB2}} 0.6V$$

### PRECISION ENABLE

The enable (EN) pin of the LM21212-1 allows the output to be toggled on and off. This pin is a precision analog input. When the voltage exceeds 1.35V, the controller will try to regulate the output voltage as long as the input voltage has exceeded the UVLO voltage of 2.70V. There is an internal current source connected to EN so if enable is not used, the device will turn on automatically. If EN is not toggled directly the device can be preprogrammed to turn on at a certain input voltage higher than the UVLO voltage. This can be done with an external resistor divider from AVIN to EN and EN to AGND as shown below in Figure 6.

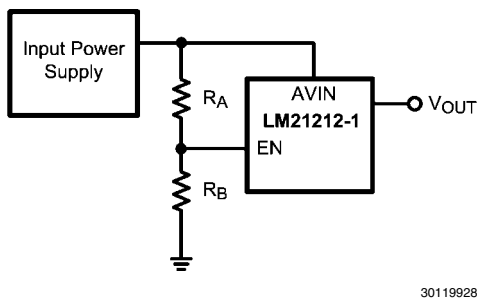

FIGURE 6. Enable Startup Through Vin

The resistor values of  $R_A$  and  $R_B$  can be relatively sized to allow EN to reach the enable threshold voltage depending on the input supply voltage. With the enable current source accounted for, the equation solving for  $R_A$  is shown below:

$$R_A = \frac{R_B(V_{PVIN} - 1.35V)}{1.35V - I_{EN}R_B}$$

In the above equation,  $R_A$  is the resistor from  $V_{IN}$  to enable,  $R_B$  is the resistor from enable to ground,  $I_{EN}$  is the internal enable pull-up current (2 $\mu$ A) and 1.35V is the fixed precision enable threshold voltage. Typical values for  $R_B$  range from 10k $\Omega$  to 100k $\Omega$ .

### SOFT START

When EN has exceeded 1.35V, and both PVIN and AVIN have exceeded the UVLO threshold, the LM21212-1 will begin charging the output linearly to the voltage level dictated by the feedback resistor network. The LM21212-1 employs a user adjustable soft start circuit to lengthen the charging time of the output set by a capacitor from the soft start pin to ground. After enable exceeds 1.35V, an internal 2  $\mu$ A current source begins to charge the soft start capacitor. This allows the user to limit inrush currents due to a high output capacitance and not cause an over current condition. Adding a soft-start capacitor can also reduce the stress on the input rail. Larger capacitor values will result in longer start up times. Use the equation below to approximate the size of the soft-start capacitor:

$$\frac{t_{SS} \times I_{SS}}{0.6V} = C_{SS}$$

where  $I_{SS}$  is nominally 2  $\mu$ A and  $t_{SS}$  is the desired startup time. If  $V_{IN}$  is higher than the UVLO level and enable is toggled high the soft start sequence will begin. There is a small delay between enable transitioning high and the beginning of the soft start sequence. This delay allows the LM21212-1 to initialize its internal circuitry. Once the output has charged to 90% of the nominal output voltage the power good flag will transition high. This behavior is illustrated in Figure 7.

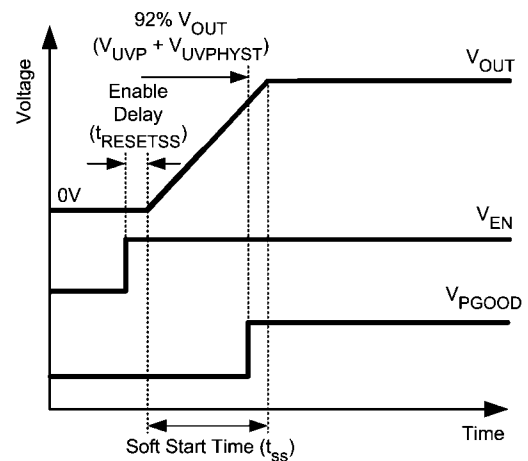
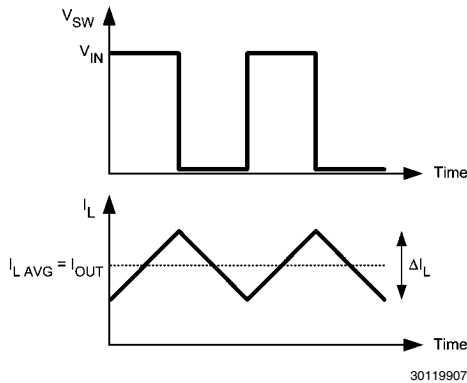

FIGURE 7. Soft Start Timing

As shown above, the size of the capacitor is influenced by the nominal feedback voltage level 0.6V, the soft-start charging current  $I_{SS}$  (2  $\mu$ A), and the desired soft start time. If no soft-start capacitor is used then the LM21212-1 defaults to a minimum startup time of 500  $\mu$ s. The LM21212-1 will not startup faster than 500  $\mu$ s. When enable is cycled or the device enters UVLO, the charge developed on the soft-start capacitor is discharged to reset the startup process. This also happens when the device enters short circuit mode from an over-current event.

## INDUCTOR SELECTION

The inductor (L) used in the application will influence the ripple current and the efficiency of the system. The first selection criteria is to define a ripple current,  $\Delta I_L$ . In a buck converter, it is typically selected to run between 20% to 30% of the maximum output current. *Figure 8* shows the ripple current in a standard buck converter operating in continuous conduction mode. Larger ripple current will result in a smaller inductance value, which will lead to a lower series resistance in the inductor, and improved efficiency. However, larger ripple current will also cause the device to operate in discontinuous conduction mode at a higher average output current.



**FIGURE 8. Switch and Inductor Current Waveforms**

Once the ripple current has been determined, the appropriate inductor size can be calculated using the following equation:

$$L = \frac{(V_{IN} - V_{OUT}) \cdot D}{\Delta I_L \cdot f_{SW}}$$

## OUTPUT CAPACITOR SELECTION

The output capacitor,  $C_{OUT}$ , filters the inductor ripple current and provides a source of charge for transient load conditions. A wide range of output capacitors may be used with the LM21212-1 that provide various advantages. The best performance is typically obtained using ceramic, SP or OSCON type chemistries. Typical trade-offs are that the ceramic capacitor provides extremely low ESR to reduce the output ripple voltage and noise spikes, while the SP and OSCON capacitors provide a large bulk capacitance in a small volume for transient loading conditions.

When selecting the value for the output capacitor, the two performance characteristics to consider are the output voltage ripple and transient response. The output voltage ripple can be approximated by using the following formula:

$$\Delta V_{OUT} \approx \Delta I_L \times \left[ R_{ESR} + \frac{1}{8 \times f_{SW} \times C_{OUT}} \right]$$

where  $\Delta V_{OUT}$  (V) is the amount of peak to peak voltage ripple at the power supply output,  $R_{ESR}$  ( $\Omega$ ) is the series resistance of the output capacitor,  $f_{SW}$  (Hz) is the switching frequency, and  $C_{OUT}$  (F) is the output capacitance used in the design. The amount of output ripple that can be tolerated is application specific; however a general recommendation is to keep the output ripple less than 1% of the rated output voltage. Keep in mind ceramic capacitors are sometimes preferred because they have very low ESR; however, depending on

package and voltage rating of the capacitor the value of the capacitance can drop significantly with applied voltage. The output capacitor selection will also affect the output voltage droop during a load transient. The peak droop on the output voltage during a load transient is dependent on many factors; however, an approximation of the transient droop ignoring loop bandwidth can be obtained using the following equation:

$$V_{DROOP} = \Delta I_{OUTSTEP} \times R_{ESR} + \frac{L \times \Delta I_{OUTSTEP}^2}{C_{OUT} \times (V_{IN} - V_{OUT})}$$

where,  $C_{OUT}$  (F) is the minimum required output capacitance, L (H) is the value of the inductor,  $V_{DROOP}$  (V) is the output voltage drop ignoring loop bandwidth considerations,  $\Delta I_{OUTSTEP}$  (A) is the load step change,  $R_{ESR}$  ( $\Omega$ ) is the output capacitor ESR,  $V_{IN}$  (V) is the input voltage, and  $V_{OUT}$  (V) is the set regulator output voltage. Both the tolerance and voltage coefficient of the capacitor should be examined when designing for a specific output ripple or transient droop target.

## INPUT CAPACITOR SELECTION

Quality input capacitors are necessary to limit the ripple voltage at the VIN pin while supplying most of the switch current during the on-time. Additionally, they help minimize input voltage droop in an output current transient condition. In general, it is recommended to use a ceramic capacitor for the input as it provides both a low impedance and small footprint. Use of a high grade dielectric for the ceramic capacitor, such as X5R or X7R, will provide improved over-temperature performance and also minimize the DC voltage derating that occurs with Y5V capacitors. The input capacitors  $C_{IN1}$  and  $C_{IN2}$  should be placed as close as possible to the PVIN and PGND pins.

Non-ceramic input capacitors should be selected for RMS current rating and minimum ripple voltage. A good approximation for the required ripple current rating is given by the relationship:

$$I_{IN-RMS} = I_{OUT} \sqrt{D(1 - D)}$$

As indicated by the RMS ripple current equation, highest requirement for RMS current rating occurs at 50% duty cycle. For this case, the RMS ripple current rating of the input capacitor should be greater than half the output current. For best performance, low ESR ceramic capacitors should be placed in parallel with higher capacitance capacitors to provide the best input filtering for the device.

When operating at low input voltages (3.3V or lower), additional capacitance may be necessary to protect from triggering an under-voltage condition on an output current transient. This will depend on the impedance between the input voltage supply and the LM21212-1, as well as the magnitude and slew rate of the output transient.

The AVIN pin requires a 1  $\mu$ F ceramic capacitor to AGND and a 1  $\Omega$  resistor to PVIN. This RC network will filter inherent noise on PVIN from the sensitive analog circuitry connected to AVIN.

## CONTROL LOOP COMPENSATION

The LM21212-1 incorporates a high bandwidth amplifier between the FB and COMP pins to allow the user to design a compensation network that matches the application. This section will walk through the various steps in obtaining the open loop transfer function.

There are three main blocks of a voltage mode buck switcher that the power supply designer must consider when designing the control system; the power train, modulator, and the compensated error amplifier. A closed loop diagram is shown in *Figure 9*.

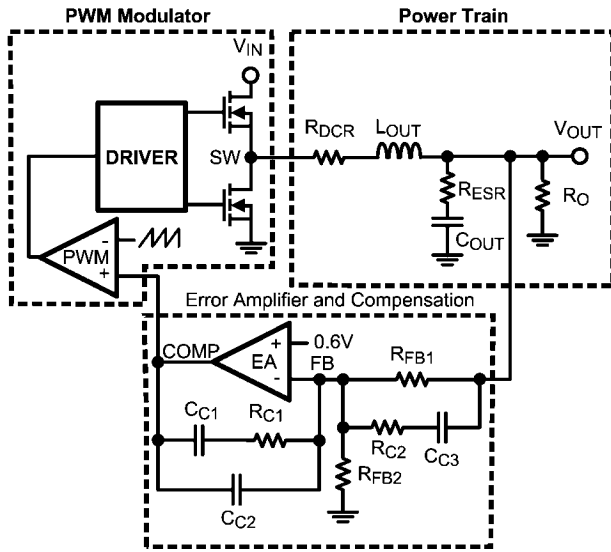

**FIGURE 9. Loop Diagram**

The power train consists of the output inductor (L) with DCR (DC resistance  $R_{DCR}$ ), output capacitor ( $C_0$ ) with ESR (effective series resistance  $R_{ESR}$ ), and load resistance ( $R_0$ ). The error amplifier (EA) constantly forces FB to 0.6V. The passive compensation components around the error amplifier help maintain system stability. The modulator creates the duty cycle by comparing the error amplifier signal with an internally generated ramp set at the switching frequency.

There are three transfer functions that must be taken into consideration when obtaining the total open loop transfer function; COMP to SW (Modulator), SW to  $V_{OUT}$  (Power Train), and  $V_{OUT}$  to COMP (Error Amplifier). The COMP to SW transfer function is simply the gain of the PWM modulator.

$$G_{PWM} = \frac{V_{in}}{\Delta V_{ramp}}$$

where  $\Delta V_{RAMP}$  is the oscillator peak-to-peak ramp voltage (nominally 0.8 V). The SW to COMP transfer function includes the output inductor, output capacitor, and output load resistance. The inductor and capacitor create two complex poles at a frequency described by:

$$f_{LC} = \frac{1}{2\pi} \sqrt{\frac{R_0 + R_{DCR}}{L_{OUT} C_{OUT} (R_0 + R_{ESR})}}$$

In addition to two complex poles, a left half plane zero is created by the output capacitor ESR located at a frequency described by:

$$f_{esr} = \frac{1}{2\pi C_0 R_{esr}}$$

A Bode plot showing the power train response can be seen below.

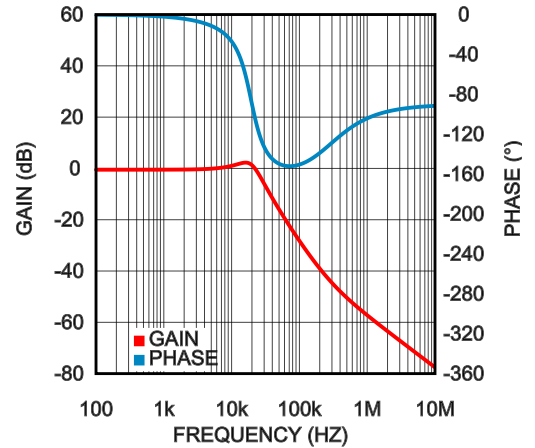

**FIGURE 10. Power Train Bode Plot**

The complex poles created by the output inductor and capacitor cause a 180° phase shift at the resonant frequency as seen in *Figure 10*. The phase is boosted back up to -90° due to the output capacitor ESR zero. The 180° phase shift must be compensated out and phase boosted through the error amplifier to stabilize the closed loop response. The compensation network shown around the error amplifier in *Figure 9* creates two poles, two zeros and a pole at the origin. Placing these poles and zeros at the correct frequencies will stabilize the closed loop response. The Compensated Error Amplifier transfer function is:

$$G_{EA} = K_m \frac{\left(\frac{s}{2\pi f_{z1}} + 1\right) \left(\frac{s}{2\pi f_{z2}} + 1\right)}{s \left(\frac{s}{2\pi f_{p1}} + 1\right) \left(\frac{s}{2\pi f_{p2}} + 1\right)}$$

The pole located at the origin gives high open loop gain at DC, translating into improved load regulation accuracy. This pole occurs at a very low frequency due to the limited gain of the error amplifier, however, it can be approximated at DC for the purposes of compensation. The other two poles and two zeros can be located accordingly to stabilize the voltage mode loop depending on the power stage complex poles and Q. *Figure 11* is an illustration of what the Error Amplifier Compensation transfer function will look like.



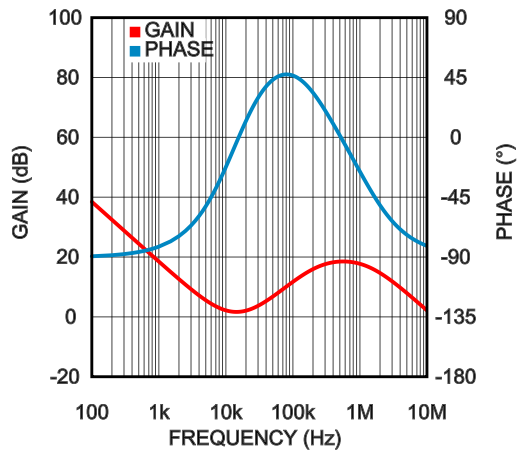

30119941

**FIGURE 11. Type 3 Compensation Network Bode Plot**

As seen in [Figure 11](#), the two zeros ( $f_{LC}/2$ ,  $f_{LC}$ ) in the compensation network give a phase boost. This will cancel out the effects of the phase loss from the output filter. The compensation network also adds two poles to the system. One pole should be located at the zero caused by the output capacitor ESR ( $f_{ESR}$ ) and the other pole should be at half the switching frequency ( $f_{SW}/2$ ) to roll off the high frequency response. The dependency of the pole and zero locations on the compensation components is described below.

$$f_{Z1} = \frac{f_{LC}}{2} = \frac{1}{2\pi R_{C1} C_{C1}}$$

$$f_{Z2} = f_{LC} = \frac{1}{2\pi(R_{C1} + R_{FB1})C_{C3}}$$

$$f_{P1} = f_{ESR} = \frac{1}{2\pi R_{C2} C_{C3}}$$

$$f_{P2} = \frac{f_{SW}}{2} = \frac{C_{C1} + C_{C2}}{2\pi R_{C1} C_{C1} C_{C2}}$$

An example of the step-by-step procedure to generate compensation component values using the typical application setup, (see [Figure 16](#)), is given. The parameters needed for the compensation values are given in the table below.

Parameter	Value
$V_{IN}$	5.0V
$V_{OUT}$	1.2V
$I_{OUT}$	12A
$f_{CROSSOVER}$	100 kHz
L	0.56 $\mu$ H
$R_{DCR}$	1.8 m $\Omega$
$C_O$	150 $\mu$ F
$R_{ESR}$	1.0 m $\Omega$
$\Delta V_{RAMP}$	0.8V
$f_{SW}$	500 kHz

where  $\Delta V_{RAMP}$  is the oscillator peak-to-peak ramp voltage (nominally 0.8V), and  $f_{crossover}$  is the frequency at which the

open-loop gain is a magnitude of 1. It is recommended that the  $f_{crossover}$  not exceed one-fifth of the switching frequency. The output capacitance,  $C_O$ , depends on capacitor chemistry and bias voltage. For Multi-Layer Ceramic Capacitors (MLCC), the total capacitance will degrade as the DC bias voltage is increased. Measuring the actual capacitance value for the output capacitors at the output voltage is recommended to accurately calculate the compensation network. The example given here is the total output capacitance using the three MLCC output capacitors biased at 1.2V, as seen in the typical application schematic, [Figure 16](#). Note that it is more conservative, from a stability standpoint, to err on the side of a smaller output capacitance value in the compensation calculations rather than a larger, as this will result in a lower bandwidth but increased phase margin.

First, the value of  $R_{FB1}$  should be chosen. A typical value is 10k $\Omega$ . From this, the value of  $R_{C1}$  can be calculated to set the mid-band gain so that the desired crossover frequency is achieved:

$$R_{C1} = \frac{f_{crossover}}{f_{LC}} \cdot \frac{\Delta V_{RAMP}}{V_{IN}} \cdot R_{FB1}$$

$$= \frac{100 \text{ kHz}}{17.4 \text{ kHz}} \cdot \frac{0.8 \text{ V}}{5.0 \text{ V}} \cdot 10 \text{ k}\Omega$$

$$= 9.2 \text{ k}\Omega$$

Next, the value of  $C_{C1}$  can be calculated by placing a zero at half of the LC double pole frequency ( $f_{LC}$ ):

$$C_{C1} = \frac{1}{\pi f_{LC} R_{C1}}$$

$$= 1.99 \text{ nF}$$

Now the value of  $C_{C2}$  can be calculated to place a pole at half of the switching frequency ( $f_{SW}$ ):

$$C_{C2} = \frac{C_{C1}}{\pi f_{SW} R_{C1} C_{C1} - 1}$$

$$= 71 \text{ pF}$$

$R_{C2}$  can then be calculated to set the second zero at the LC double pole frequency:

$$R_{C2} = \frac{R_{FB1} f_{LC}}{f_{ESR} - f_{LC}}$$

$$= 166 \Omega$$

Last,  $C_{C3}$  can be calculated to place a pole at the same frequency as the zero created by the output capacitor ESR:

$$C_{C3} = \frac{1}{2\pi f_{ESR} R_{C2}}$$

$$= 898 \text{ pF}$$

An illustration of the total loop response can be seen in [Figure 12](#).

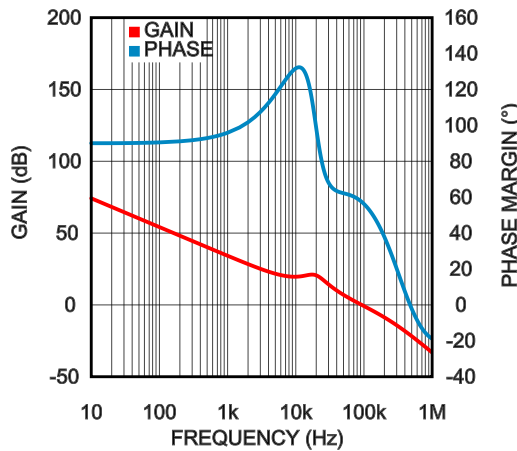

30119939

FIGURE 12. Loop Response

It is important to verify the stability by either observing the load transient response or by using a network analyzer. A phase margin between 45° and 70° is usually desired for voltage mode systems. Excessive phase margin can cause slow system response to load transients and low phase margin may cause an oscillatory load transient response. If the load step response peak deviation is larger than desired, increasing  $f_{\text{CROSSOVER}}$  and recalculating the compensation components may help but usually at the expense of phase margin.

### THERMAL CONSIDERATIONS

The thermal characteristics of the LM21212-1 are specified using the parameter  $\theta_{\text{JA}}$ , which relates the junction temperature to the ambient temperature. Although the value of  $\theta_{\text{JA}}$  is dependant on many variables, it still can be used to approximate the operating junction temperature of the device.

To obtain an estimate of the device junction temperature, one may use the following relationship:

$$T_J = P_D \cdot \theta_{\text{JA}} + T_A$$

and

$$P_D = P_{\text{IN}} \cdot (1 - \text{Efficiency}) - I_{\text{OUT}}^2 \cdot R_{\text{DCR}}$$

Where:

$T_J$  is the junction temperature in °C,  $P_{\text{IN}}$  is the input power in Watts ( $P_{\text{IN}} = V_{\text{IN}} \times I_{\text{IN}}$ ),  $\theta_{\text{JA}}$  is the junction to ambient thermal resistance for the LM21212-1,  $T_A$  is the ambient temperature in °C, and  $I_{\text{OUT}}$  is the output load current.

It is important to always keep the operating junction temperature ( $T_J$ ) below 125°C for reliable operation. If the junction temperature exceeds 165°C the device will cycle in and out of thermal shutdown. If thermal shutdown occurs it is a sign of inadequate heatsinking or excessive power dissipation in the device.

Figure 13, shown below, provides a better approximation of the  $\theta_{\text{JA}}$  for a given PCB copper area. The PCB used in this test consisted of 4 layers: 1oz. copper was used for the internal layers while the external layers were plated to 2oz. copper weight. To provide an optimal thermal connection, a 3 x 4 array of 8 mil. vias under the thermal pad were used, and an

additional sixteen 8 mil. vias under the rest of the device were used to connect the 4 layers.

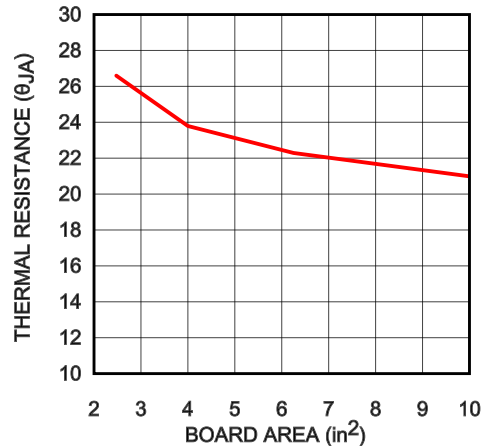

30119942

FIGURE 13. Thermal Resistance vs PCB Area (4 Layer Board)

Figure 14 shows a plot of the maximum ambient temperature vs. output current for the typical application circuit shown in Figure 16, assuming a  $\theta_{\text{JA}}$  value of 24 °C/W.

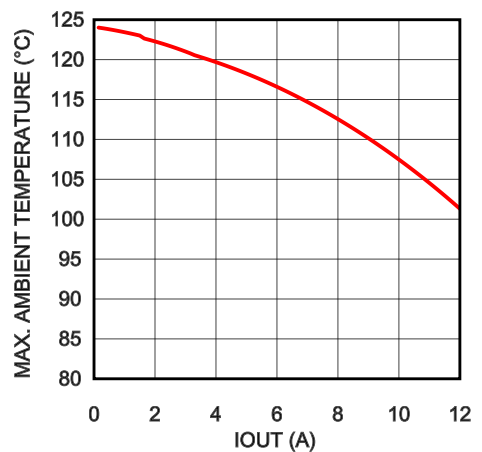

30119944

FIGURE 14. Maximum Ambient Temperature vs. Output Current (0 LFM)

### PCB LAYOUT CONSIDERATIONS

PC board layout is an important part of DC-DC converter design. Poor board layout can disrupt the performance of a DC-DC converter and surrounding circuitry by contributing to EMI, ground bounce, and resistive voltage loss in the traces. These can send erroneous signals to the DC-DC converter resulting in poor regulation or instability.

Good layout can be implemented by following a few simple design rules.

1. Minimize area of switched current loops. In a buck regulator there are two loops where currents are switched at high slew rates. The first loop starts from the input capacitor, to the regulator PVIN pin, to the regulator SW pin, to the inductor then out to the output capacitor and load. The second loop starts

from the output capacitor ground, to the regulator GND pins, to the inductor and then out to the load (see [Figure 15](#)). To minimize both loop areas, the input capacitor should be placed as close as possible to the VIN pin. Grounding for both the input and output capacitor should be close. Ideally, a ground plane should be placed on the top layer that connects the PGND pins, the exposed pad (EP) of the device, and the ground connections of the input and output capacitors in a small area near pin 10 and 11 of the device. The inductor should be placed as close as possible to the SW pin and output capacitor.

2. Minimize the copper area of the switch node. The six SW pins should be routed on a single top plane to the pad of the inductor. The inductor should be placed as close as possible to the switch pins of the device with a wide trace to minimize conductive losses. The inductor can be placed on the bottom side of the PCB relative to the LM21212-1, but care must be taken to not allow any coupling of the magnetic field of the inductor into the sensitive feedback or compensation traces.

3. Have a solid ground plane between PGND, the EP and the input and output cap. ground connections. The ground connections for the AGND, compensation, feedback, and soft-start components should be physically isolated (located near pin 1 and 20) from the power ground plane but a separate ground connection is not necessary. If not properly handled,

poor grounding can result in degraded load regulation or erratic switching behavior.

4. Carefully route the connection from the VOUT signal to the compensation network. This node is high impedance and can be susceptible to noise coupling. The trace should be routed away from the SW pin and inductor to avoid contaminating the feedback signal with switch noise.

5. Make input and output bus connections as wide as possible. This reduces any voltage drops on the input or output of the converter and can improve efficiency. Voltage accuracy at the load is important so make sure feedback voltage sense is made at the load. Doing so will correct for voltage drops at the load and provide the best output accuracy.

6. Provide adequate device heatsinking. For most 12A designs a four layer board is recommended. Use as many vias as is possible to connect the EP to the power plane heatsink. The vias located underneath the EP will wick solder into them if they are not filled. Complete solder coverage of the EP to the board is required to achieve the  $\theta_{JA}$  values described in the previous section. Either an adequate amount of solder must be applied to the EP pad to fill the vias, or the vias must be filled during manufacturing. See the Thermal Considerations section to ensure enough copper heatsinking area is used to keep the junction temperature below 125°C.

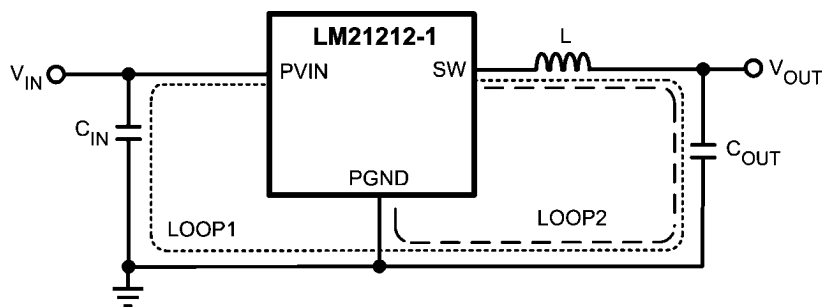

30119948

**FIGURE 15. Schematic of LM21212-1 Highlighting Layout Sensitive Nodes**

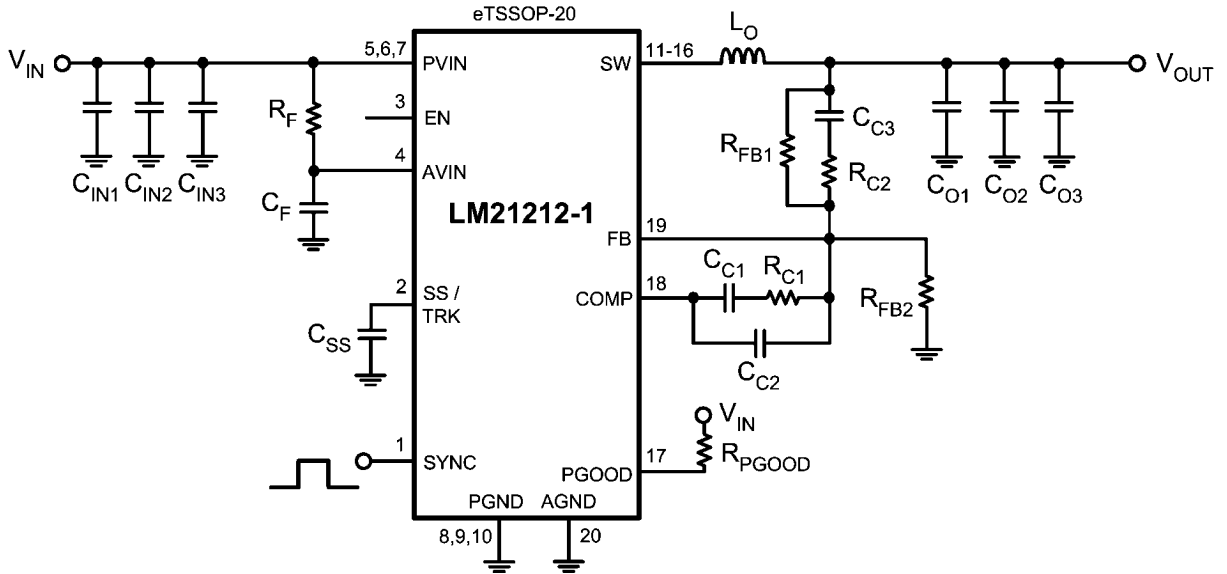

30119943

FIGURE 16. Typical Application Schematic 1

**Bill of Materials ( $V_{IN} = 3.3 - 5.5V$ ,  $V_{OUT} = 1.2V$ ,  $I_{OUT} = 12A$ ,  $f_{SW} = 500kHz$ )**

ID	DESCRIPTION	VENDOR	PART NUMBER	QUANTITY
$C_F$	CAP, CERM, 1uF, 10V, +/-10%, X7R, 0603	MuRata	GRM188R71A105KA61D	1
$C_{IN1}$ , $C_{IN2}$ , $C_{IN3}$ , $C_{O1}$ , $C_{O2}$ , $C_{O3}$	CAP, CERM, 100uF, 6.3V, +/-20%, X5R, 1206	MuRata	GRM31CR60J107ME39L	6
$C_{C1}$	CAP, CERM, 1800pF, 50V, +/-5%, C0G/NP0, 0603	TDK	C1608C0G1H182J	1
$C_{C2}$	CAP, CERM, 68pF, 50V, +/-5%, C0G/NP0, 0603	TDK	C1608C0G1H680J	1
$C_{C3}$	CAP, CERM, 820pF, 50V, +/-5%, C0G/NP0, 0603	TDK	C1608C0G1H821J	1
$C_{SS}$	CAP, CERM, 0.033uF, 16V, +/-10%, X7R, 0603	MuRata	GRM188R71C333KA01D	1
$L_O$	Inductor, Shielded Drum Core, Powdered Iron, 560nH, 27.5A, 0.0018 ohm, SMD	Vishay-Dale	IHLP4040DZERR56M01	1
$R_F$	RES, 1.0 ohm, 5%, 0.1W, 0603	Vishay-Dale	CRCW06031R00JNEA	1
$R_{C1}$	RES, 9.31k ohm, 1%, 0.1W, 0603	Vishay-Dale	CRCW06039K31FKEA	1
$R_{C2}$	RES, 165 ohm, 1%, 0.1W, 0603	Vishay-Dale	CRCW0603165RFKEA	1
$R_{FB1}$ , $R_{FB2}$ , $R_{PG00D}$	RES, 10k ohm, 1%, 0.1W, 0603	Vishay-Dale	CRCW060310K0FKEA	3

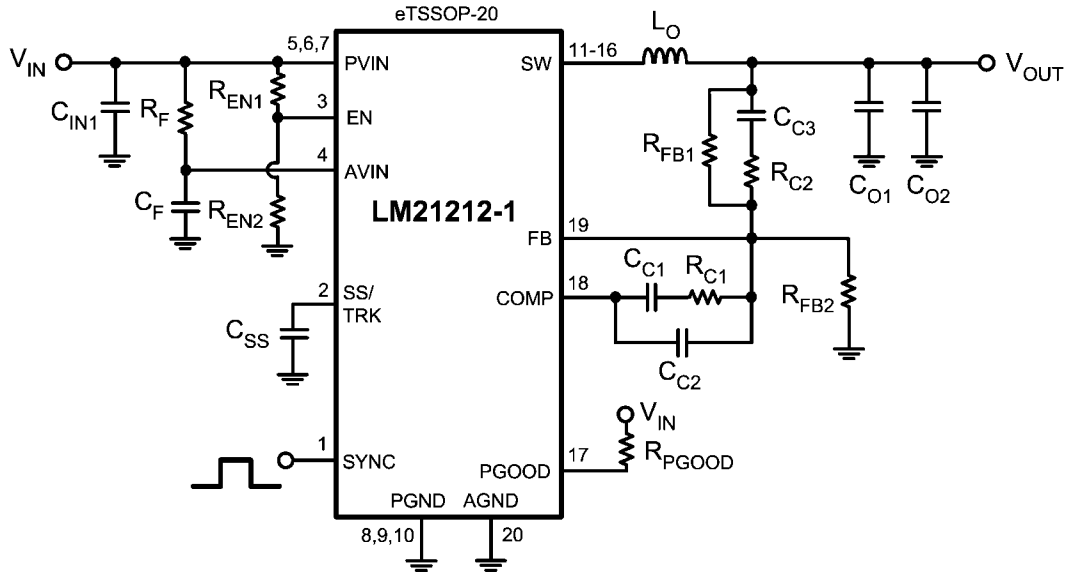

30119981

FIGURE 17. Typical Application Schematic 2

### Bill of Materials ( $V_{IN} = 4.0 - 5.5V$ , $V_{OUT} = 0.9V$ , $I_{OUT} = 8A$ , $f_{SW} = 1MHz$ )

ID	DESCRIPTION	VENDOR	PART NUMBER	QUANTITY
$C_F$	CAP, CERM, 1uF, 10V, +/-10%, X7R, 0603	MuRata	GRM188R71A105KA61D	1
$C_{IN1}$ , $C_{O1}$ , $C_{O2}$	CAP, CERM, 100uF, 6.3V, +/-20%, X5R, 1206	MuRata	GRM31CR60J107ME39L	3
$C_{C1}$	CAP, CERM, 1800pF, 50V, +/-5%, C0G/NP0, 0603	MuRata	GRM1885C1H182JA01D	1
$C_{C2}$	CAP, CERM, 68pF, 50V, +/-5%, C0G/NP0, 0603	TDK	C1608C0G1H680J	1
$C_{C3}$	CAP, CERM, 470pF, 50V, +/-5%, C0G/NP0, 0603	TDK	C1608C0G1H471J	1
$C_{SS}$	CAP, CERM, 0.033uF, 16V, +/-10%, X7R, 0603	MuRata	GRM188R71C333KA01D	1
$L_O$	Inductor, Shielded Drum Core, Superflux, 240nH, 20A, 0.001 ohm, SMD	Würth Elektronik eiSos	744314024	1
$R_F$	RES, 1.0 ohm, 5%, 0.1W, 0603	Vishay-Dale	CRCW06031R00JNEA	1
$R_{C1}$	RES, 4.87k ohm, 1%, 0.1W, 0603	Vishay-Dale	CRCW06034K87FKEA	1
$R_{C2}$	RES, 210 ohm, 1%, 0.1W, 0603	Vishay-Dale	CRCW0603210RFKEA	1
$R_{EN1}$ , $R_{FB1}$ , $R_{PGOOD}$	RES, 10k ohm, 1%, 0.1W, 0603	Vishay-Dale	CRCW060310K0FKEA	3
$R_{EN2}$	RES, 19.6k ohm, 1%, 0.1W, 0603	Vishay-Dale	CRCW060319K6FKEA	1
$R_{FB2}$	RES, 20.0k ohm, 1%, 0.1W, 0603	Vishay-Dale	CRCW060320K0FKEA	1

**Physical Dimensions** inches (millimeters) unless otherwise noted

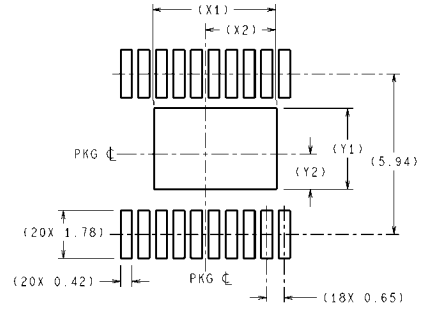
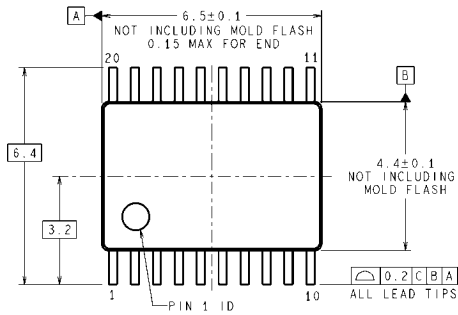

LAND PATTERN RECOMENDATION

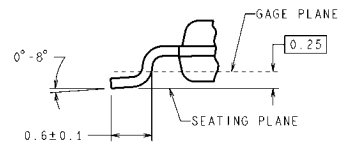
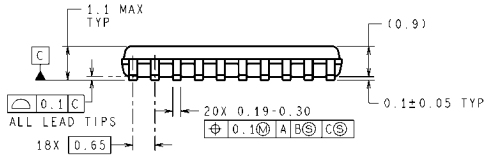

DETAIL A  
TYPICAL

DIMENSIONS ARE IN MILLIMETERS  
DIMENSIONS IN ( ) FOR REFERENCE ONLY

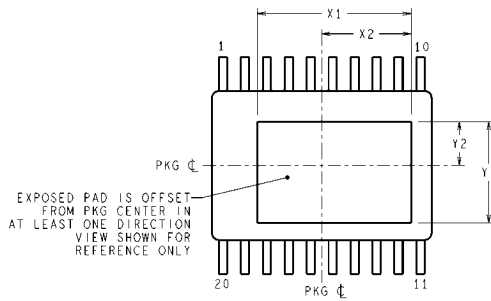

PAD SIZE CODE IN DWG No (XX)	PAD SIZE		X2	Y2
	X1	Y1		
AA	4.55	3.32	2.645	1.66

**20-Lead eTSSOP Package**  
**NS Package Number MYB20**

MYB20XX (Rev C)

# Notes

LM21212-1

## Notes

For more National Semiconductor product information and proven design tools, visit the following Web sites at:  
[www.national.com](http://www.national.com)

Products		Design Support	
Amplifiers	<a href="http://www.national.com/amplifiers">www.national.com/amplifiers</a>	WEBENCH® Tools	<a href="http://www.national.com/webench">www.national.com/webench</a>
Audio	<a href="http://www.national.com/audio">www.national.com/audio</a>	App Notes	<a href="http://www.national.com/appnotes">www.national.com/appnotes</a>
Clock and Timing	<a href="http://www.national.com/timing">www.national.com/timing</a>	Reference Designs	<a href="http://www.national.com/refdesigns">www.national.com/refdesigns</a>
Data Converters	<a href="http://www.national.com/adc">www.national.com/adc</a>	Samples	<a href="http://www.national.com/samples">www.national.com/samples</a>
Interface	<a href="http://www.national.com/interface">www.national.com/interface</a>	Eval Boards	<a href="http://www.national.com/evalboards">www.national.com/evalboards</a>
LVDS	<a href="http://www.national.com/lvds">www.national.com/lvds</a>	Packaging	<a href="http://www.national.com/packaging">www.national.com/packaging</a>
Power Management	<a href="http://www.national.com/power">www.national.com/power</a>	Green Compliance	<a href="http://www.national.com/quality/green">www.national.com/quality/green</a>
Switching Regulators	<a href="http://www.national.com/switchers">www.national.com/switchers</a>	Distributors	<a href="http://www.national.com/contacts">www.national.com/contacts</a>
LDOs	<a href="http://www.national.com/ldo">www.national.com/ldo</a>	Quality and Reliability	<a href="http://www.national.com/quality">www.national.com/quality</a>
LED Lighting	<a href="http://www.national.com/led">www.national.com/led</a>	Feedback/Support	<a href="http://www.national.com/feedback">www.national.com/feedback</a>
Voltage References	<a href="http://www.national.com/vref">www.national.com/vref</a>	Design Made Easy	<a href="http://www.national.com/easy">www.national.com/easy</a>
PowerWise® Solutions	<a href="http://www.national.com/powerwise">www.national.com/powerwise</a>	Applications & Markets	<a href="http://www.national.com/solutions">www.national.com/solutions</a>
Serial Digital Interface (SDI)	<a href="http://www.national.com/sdi">www.national.com/sdi</a>	Mil/Aero	<a href="http://www.national.com/milaero">www.national.com/milaero</a>
Temperature Sensors	<a href="http://www.national.com/tempensors">www.national.com/tempensors</a>	SolarMagic™	<a href="http://www.national.com/solarmagic">www.national.com/solarmagic</a>
PLL/VCO	<a href="http://www.national.com/wireless">www.national.com/wireless</a>	PowerWise® Design University	<a href="http://www.national.com/training">www.national.com/training</a>

THE CONTENTS OF THIS DOCUMENT ARE PROVIDED IN CONNECTION WITH NATIONAL SEMICONDUCTOR CORPORATION ("NATIONAL") PRODUCTS. NATIONAL MAKES NO REPRESENTATIONS OR WARRANTIES WITH RESPECT TO THE ACCURACY OR COMPLETENESS OF THE CONTENTS OF THIS PUBLICATION AND RESERVES THE RIGHT TO MAKE CHANGES TO SPECIFICATIONS AND PRODUCT DESCRIPTIONS AT ANY TIME WITHOUT NOTICE. NO LICENSE, WHETHER EXPRESS, IMPLIED, ARISING BY ESTOPPEL OR OTHERWISE, TO ANY INTELLECTUAL PROPERTY RIGHTS IS GRANTED BY THIS DOCUMENT.

TESTING AND OTHER QUALITY CONTROLS ARE USED TO THE EXTENT NATIONAL DEEMS NECESSARY TO SUPPORT NATIONAL'S PRODUCT WARRANTY. EXCEPT WHERE MANDATED BY GOVERNMENT REQUIREMENTS, TESTING OF ALL PARAMETERS OF EACH PRODUCT IS NOT NECESSARILY PERFORMED. NATIONAL ASSUMES NO LIABILITY FOR APPLICATIONS ASSISTANCE OR BUYER PRODUCT DESIGN. BUYERS ARE RESPONSIBLE FOR THEIR PRODUCTS AND APPLICATIONS USING NATIONAL COMPONENTS. PRIOR TO USING OR DISTRIBUTING ANY PRODUCTS THAT INCLUDE NATIONAL COMPONENTS, BUYERS SHOULD PROVIDE ADEQUATE DESIGN, TESTING AND OPERATING SAFEGUARDS.

EXCEPT AS PROVIDED IN NATIONAL'S TERMS AND CONDITIONS OF SALE FOR SUCH PRODUCTS, NATIONAL ASSUMES NO LIABILITY WHATSOEVER, AND NATIONAL DISCLAIMS ANY EXPRESS OR IMPLIED WARRANTY RELATING TO THE SALE AND/OR USE OF NATIONAL PRODUCTS INCLUDING LIABILITY OR WARRANTIES RELATING TO FITNESS FOR A PARTICULAR PURPOSE, MERCHANTABILITY, OR INFRINGEMENT OF ANY PATENT, COPYRIGHT OR OTHER INTELLECTUAL PROPERTY RIGHT.

#### LIFE SUPPORT POLICY

**NATIONAL'S PRODUCTS ARE NOT AUTHORIZED FOR USE AS CRITICAL COMPONENTS IN LIFE SUPPORT DEVICES OR SYSTEMS WITHOUT THE EXPRESS PRIOR WRITTEN APPROVAL OF THE CHIEF EXECUTIVE OFFICER AND GENERAL COUNSEL OF NATIONAL SEMICONDUCTOR CORPORATION.** As used herein:

Life support devices or systems are devices which (a) are intended for surgical implant into the body, or (b) support or sustain life and whose failure to perform when properly used in accordance with instructions for use provided in the labeling can be reasonably expected to result in a significant injury to the user. A critical component is any component in a life support device or system whose failure to perform can be reasonably expected to cause the failure of the life support device or system or to affect its safety or effectiveness.

National Semiconductor and the National Semiconductor logo are registered trademarks of National Semiconductor Corporation. All other brand or product names may be trademarks or registered trademarks of their respective holders.

Copyright© 2010 National Semiconductor Corporation

For the most current product information visit us at [www.national.com](http://www.national.com)



**National Semiconductor  
Americas Technical  
Support Center**  
Email: [support@nsc.com](mailto:support@nsc.com)  
Tel: 1-800-272-9959

**National Semiconductor Europe  
Technical Support Center**  
Email: [europe.support@nsc.com](mailto:europe.support@nsc.com)

**National Semiconductor Asia  
Pacific Technical Support Center**  
Email: [ap.support@nsc.com](mailto:ap.support@nsc.com)

**National Semiconductor Japan  
Technical Support Center**  
Email: [jpn.feedback@nsc.com](mailto:jpn.feedback@nsc.com)