

HLMP-EG2E, HLMP-EG3E

Radiometrically Tested AllnGaP LED Lamps for Sensor- Based Applications



Data Sheet



Description

Radiometrically tested Precision Optical Performance AllnGaP (Aluminium Indium Gallium Phosphide) LEDs offer increased sensor-based application design flexibility. High-resolution radiometric intensity bins (mW/sr) enable customers to precisely match LED lamp performance with sensor functionality.

Visible LEDs offer new styling alternatives – light can be leveraged to develop more attractive products. In comparison to invisible infrared sources, safety concerns are significantly improved by the human autonomic pupil response and reflexive movement away from bright light. Visible LEDs further indicate system on/off status.

The AllnGaP technology provides extremely stable light output over very long periods of time, with low power consumption.

Benefits

- Radiometric LED Characterization Decreases System Variability
- Improved System Reliability
- Visual Styling
- Visible Color for Improved Application Safety
- On/Off Indication
- Suitable for a Variety of Sensor-Based Applications

Features

- Characterized by radiometric intensity
- High optical power output
- Extremely long useful life
- Low power consumption
- Well defined spatial radiation pattern
- 634nm peak red color
- 23° and 30° viewing angle

Applications

- Photo sensor stimulus
- Infrared emitter replacement
- Solid state optical mouse sensors
- Surface imaging sensors
- Optical position and motion sensors
- Human interface devices
- Computer printer dot quality control
- Battery powered systems

Package Dimension

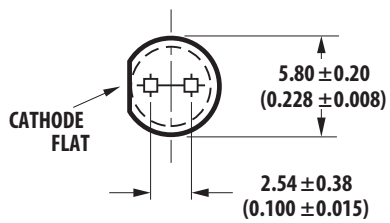
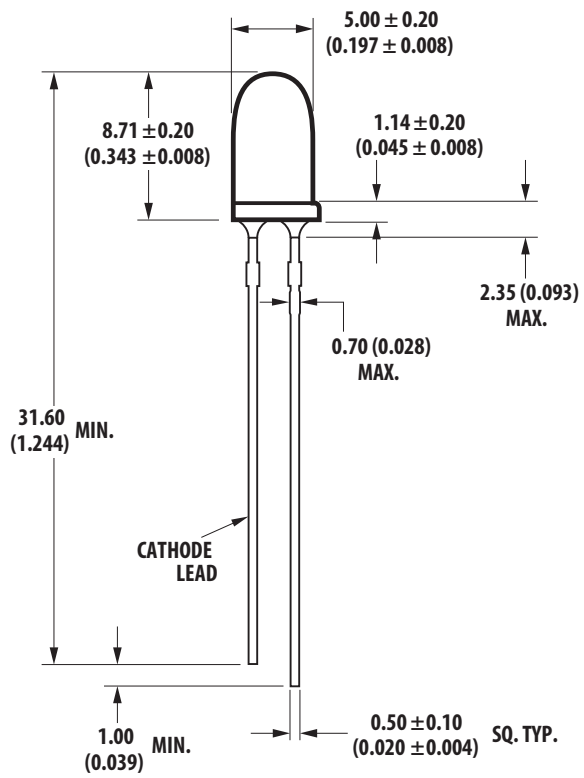

Notes:

1. All dimensions in millimeters (inches).
2. Leads are mild steel with Sn plating terminal finish.
3. The epoxy meniscus is 1.21 mm max.
4. For identification of polarity after the leads are trimmed off, please refer to the illustration below:

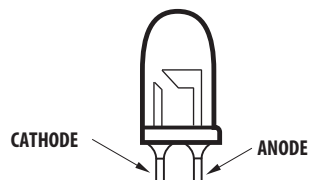

Device Selection Guide

Part Number	Viewing Angle Typ. 2 θ 1/2 (°)	Radiant Intensity I _e (mW/sr) at 20 mA-Min	Radiant Intensity I _e (mW/sr) at 20 mA-Max
HLMP-EG2E-TW000	23	36.5	75.8
HLMP-EG3E-QT000	30	21.2	43.9

Tolerance for each intensity limit is $\pm 15\%$.

Absolute Maximum Ratings

T_A = 25°C

Parameter	Red	Unit
DC Forward Current [1]	50	mA
Peak Forward Current [2]	100 [2]	mA
Reverse Voltage	5 (I _R = 100 μ A)	V
LED Junction Temperature	120	°C
Operating Temperature Range	-40 to +100	°C
Storage Temperature Range	-40 to +100	°C

Notes:

1. Derate linearly as shown in Figure 4.
2. Duty Factor 30%, frequency 1kHz.

Electrical / Optical Characteristics

T_A = 25°C

Parameter	Symbol	Min.	Typ.	Max.	Units	Test Condition
Forward Voltage	V _F	1.8	2.1	2.4	V	I _F = 20mA
Reverse Voltage	V _R	5			V	I _R = 100 μ A
Peak Wavelength	λ_{PEAK}		634		nm	Peak of Wavelength of Spectral Distribution at I _F = 20mA
Dominant Wavelength [1]	λ_d	618	626	630	nm	I _F = 20mA
Spectral Halfwidth	$\theta_{1/2}$		14		nm	Wavelength Width at Spectral, - Distribution 1/2 Power Point at I _F = 20 mA
Thermal Resistance	R θ_{J-PIN}		240		°C/W	LED Junction-to-Anode Lead
Radiant Intensity [2,3]	I _e	Refer to Device Selection Guide			mW/sr	Emitted radiant intensity at I _F = 20mA
Luminous Efficacy [4]	η_V		200		lm/W	Emitted Luminous Power/Emitted Radiant Power

Note:

1. The dominant wavelength, λ_d is derived from the CIE Chromaticity Diagram referenced to Illuminant E.
2. The radiant intensity is measured on the mechanical axis of the lamp package.
3. The optical axis is closed aligned with the package mechanical axis.
4. The luminous intensity, I_v in candelas, maybe found from the equation I_v = I_e η_V where I_e is the radiant intensity in watts per steradian and η_V is the luminous efficacy in lumens/watt.

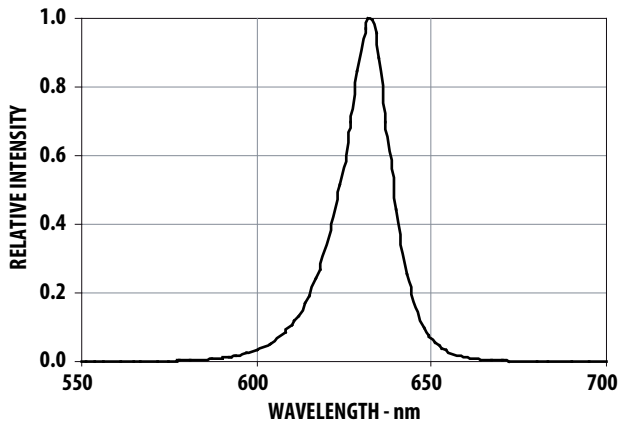

Figure 1. Relative Intensity vs Peak Wavelength

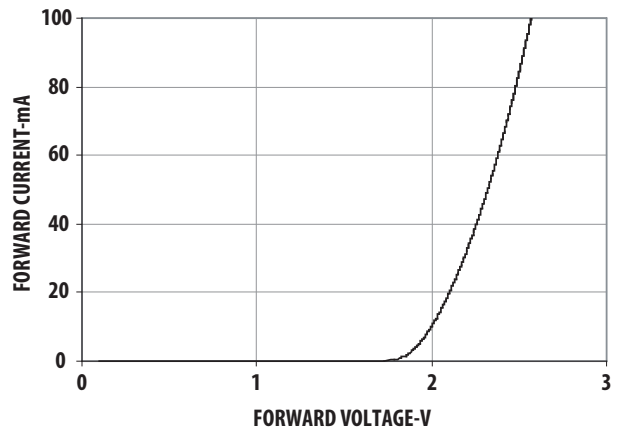

Figure 2. Forward Current vs Forward Voltage

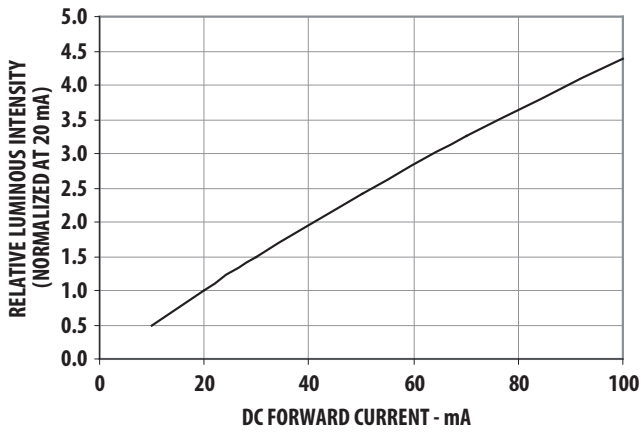

Figure 3. Relative Luminous Intensity vs Forward Current

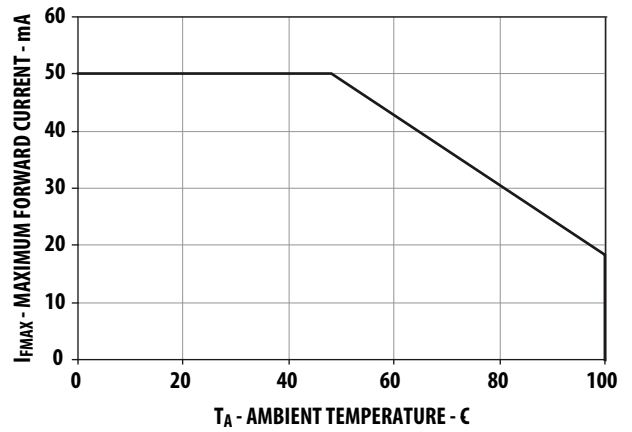

Figure 4. Maximum Forward Current vs Ambient Temperature

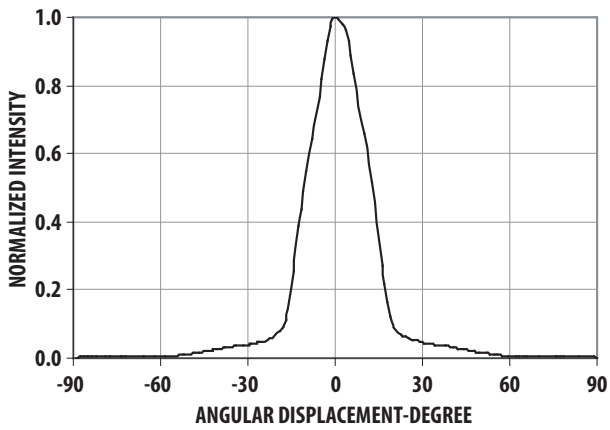

Figure 5. Radiation Pattern for 23° Viewing Angle Lamp

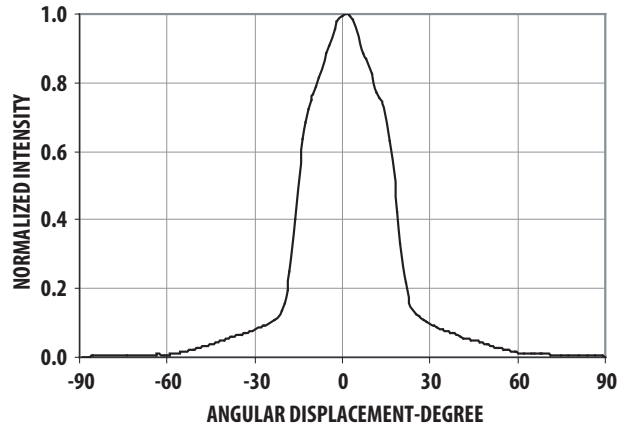

Figure 6. Radiation Pattern for 30° Viewing Angle Lamp

Radiometric Intensity Bin Limit Table

Bin ID	I _e (mW/sr) at 20 mA	
	Min	Max
Q	21.2	25.4
R	25.4	30.5
S	30.5	36.5
T	36.5	43.9
U	43.9	52.7
V	52.7	63.2
W	63.2	75.8

Tolerance for each bin limit is $\pm 15\%$

V_f Bin Table (V at 20 mA)

BIN ID	Min	Max
VD	1.8	2.0
VA	2.0	2.2
VB	2.2	2.4

Tolerance for each bin limit is ± 0.05 V.

Precautions:

Lead Forming:

- The leads of an LED lamp may be preformed or cut to length prior to insertion and soldering on PC board.
- For better control, it is recommended to use proper tool to precisely form and cut the leads to applicable length rather than doing it manually.
- If manual lead cutting is necessary, cut the leads after the soldering process. The solder connection forms a mechanical ground which prevents mechanical stress due to lead cutting from traveling into LED package. This is highly recommended for hand solder operation, as the excess lead length also acts as small heat sink.

Soldering and Handling:

- Care must be taken during PCB assembly and soldering process to prevent damage to the LED component.
- LED component may be effectively hand soldered to PCB. However, it is only recommended under unavoidable circumstances such as rework. The closest manual soldering distance of the soldering heat source (soldering iron's tip) to the body is 1.59mm. Soldering the LED using soldering iron tip closer than 1.59mm might damage the LED.



- ESD precaution must be properly applied on the soldering station and personnel to prevent ESD damage to the LED component that is ESD sensitive. Do refer to Avago application note AN 1142 for details. The soldering iron used should have grounded tip to ensure electrostatic charge is properly grounded.
- Recommended soldering condition:

	Wave Soldering [1, 2]	Manual Solder Dipping
Pre-heat temperature	105 °C Max.	-
Preheat time	60 sec Max	-
Peak temperature	260 °C Max.	260 °C Max.
Dwell time	5 sec Max.	5 sec Max

Note:

- 1) Above conditions refers to measurement with thermocouple mounted at the bottom of PCB.
 - 2) It is recommended to use only bottom preheaters in order to reduce thermal stress experienced by LED.
- Wave soldering parameters must be set and maintained according to the recommended temperature and dwell time. Customer is advised to perform daily check on the soldering profile to ensure that it is always conforming to recommended soldering conditions.

Note:

1. PCB with different size and design (component density) will have different heat mass (heat capacity). This might cause a change in temperature experienced by the board if same wave soldering setting is used. So, it is recommended to re-calibrate the soldering profile again before loading a new type of PCB.
2. Avago Technologies' high brightness LED are using high efficiency LED die with single wire bond as shown below. Customer is advised to take extra precaution during wave soldering to ensure that the maximum wave temperature does not exceed 260°C and the solder contact time does not exceeding 5sec. Over-stressing the LED during soldering process might cause premature failure to the LED due to delamination.

Avago Technologies LED Configuration

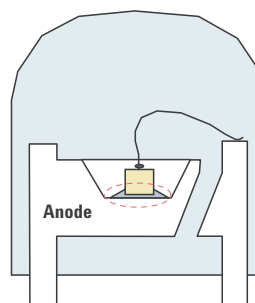

Note: Electrical connection between bottom surface of LED die and the lead frame is achieved through conductive paste.

- Any alignment fixture that is being applied during wave soldering should be loosely fitted and should not apply weight or force on LED. Non metal material is recommended as it will absorb less heat during wave soldering process.

Note: In order to further assist customer in designing jig accurately that fit Avago Technologies' product, 3D model of the product is available upon request.

- At elevated temperature, LED is more susceptible to mechanical stress. Therefore, PCB must allowed to cool down to room temperature prior to handling, which includes removal of alignment fixture or pallet.
- If PCB board contains both through hole (TH) LED and other surface mount components, it is recommended that surface mount components be soldered on the top side of the PCB. If surface mount need to be on the bottom side, these components should be soldered using reflow soldering prior to insertion the TH LED.
- Recommended PC board plated through holes (PTH) size for LED component leads.

LED component lead size	Diagonal	Plated through hole diameter
0.45 x 0.45 mm (0.018x 0.018 inch)	0.636 mm (0.025 inch)	0.98 to 1.08 mm (0.039 to 0.043 inch)
0.50 x 0.50 mm (0.020x 0.020 inch)	0.707 mm (0.028 inch)	1.05 to 1.15 mm (0.041 to 0.045 inch)

- Over-sizing the PTH can lead to twisted LED after clinching. On the other hand under sizing the PTH can cause difficulty inserting the TH LED.

Refer to application note AN5334 for more information about soldering and handling of high brightness TH LED lamps.

Example of Wave Soldering Temperature Profile for TH LED

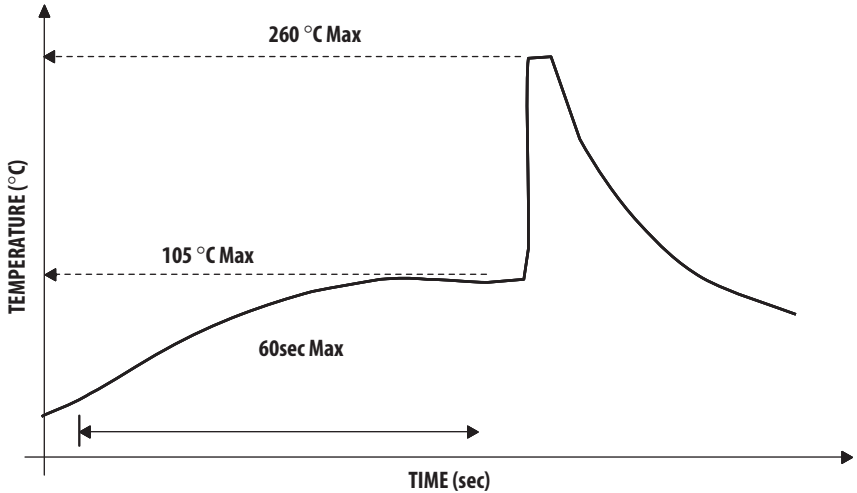

Recommended solder:
 Sn63 (Leaded solder alloy)
 SAC305 (Lead free solder alloy)

Flux: Rosin flux

Solder bath temperature: 255°C ± 5°C
 (maximum peak temperature = 260°C)

Dwell time: 3.0 sec - 5.0 sec
 (maximum = 5sec)

Note: Allow for board to be sufficiently cooled to room temperature before exerting mechanical force.

Packaging Label:

(i) Avago Mother Label: (Available on packaging box of ammo pack and shipping box)

AVAGO TECHNOLOGIES	
(1P) Item: Part Number [Barcode]	STANDARD LABEL LS0002
(1T) Lot: Lot Number [Barcode]	RoHS Compliant e3 max temp 260C
LPN: [Barcode]	(Q) QTY: Quantity [Barcode]
(9D)MFG Date: Manufacturing Date [Barcode]	CAT: Intensity Bin [Barcode]
BIN: Refer to below information	
<hr/>	
(P) Customer Item: [Barcode]	
(V) Vendor ID: [Barcode]	(9D) Date Code: Date Code [Barcode]
<hr/>	
DeptID: [Barcode]	Made In: Country of Origin [Barcode]

(ii) Avago Baby Label (Only available on bulk packaging)

 Lamps Baby Label		RoHS Compliant e3 max temp 260C
(1P) PART #: Part Number 		
(1T) LOT #: Lot Number 		
(9D)MFG DATE: Manufacturing Date 	QUANTITY: Packing Quantity 	
C/O: Country of Origin		
Customer P/N: 	CAT: Intensity Bin 	
Supplier Code: 	BIN: Refer to below information 	
	DATECODE: Date Code 	

Acronyms and Definition:

BIN:

(i) Color bin only or VF bin only

(Applicable for part number with color bins but without VF bin OR part number with VF bins and no color bin)

OR

(ii) Color bin incorporated with VF Bin

(Applicable for part number that have both color bin and VF bin)

Example:

(i) Color bin only or VF bin only

BIN: 2 (represent color bin 2 only)

BIN: VB (represent VF bin "VB" only)

(ii) Color bin incorporate with VF Bin

BIN: 2VB

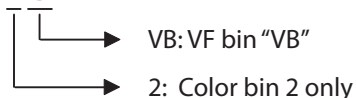

DISCLAIMER: AVAGO'S PRODUCTS AND SOFTWARE ARE NOT SPECIFICALLY DESIGNED, MANUFACTURED OR AUTHORIZED FOR SALE AS PARTS, COMPONENTS OR ASSEMBLIES FOR THE PLANNING, CONSTRUCTION, MAINTENANCE OR DIRECT OPERATION OF A NUCLEAR FACILITY OR FOR USE IN MEDICAL DEVICES OR APPLICATIONS. CUSTOMER IS SOLELY RESPONSIBLE, AND WAIVES ALL RIGHTS TO MAKE CLAIMS AGAINST AVAGO OR ITS SUPPLIERS, FOR ALL LOSS, DAMAGE, EXPENSE OR LIABILITY IN CONNECTION WITH SUCH USE.

For product information and a complete list of distributors, please go to our web site: www.avagotech.com

Avago, Avago Technologies, and the A logo are trademarks of Avago Technologies in the United States and other countries. Data subject to change. Copyright © 2005-2010 Avago Technologies. All rights reserved. AV02-2757EN - December 3, 2010

