

LMR24210

SIMPLE SWITCHER 42Vin, 1.0A Step-Down Voltage Regulator in micro SMD

General Description

The LMR24210 Synchronously Rectified Buck Converter features all required functions to implement a highly efficient and cost effective buck regulator. It is capable of supplying 2.5A to loads with an output voltage as low as 0.8V. Dual N-Channel synchronous MOSFET switches allow a low component count, thus reducing complexity and minimizing board size.

Different from most other COT regulators, the LMR24210 does not rely on output capacitor ESR for stability, and is designed to work exceptionally well with ceramic and other very low ESR output capacitors. It requires no loop compensation, results in a fast load transient response and simple circuit implementation. The operating frequency remains nearly constant with line variations due to the inverse relationship between the input voltage and the on-time. The operating frequency can be externally programmed up to 1 MHz. Protection features include V_{CC} under-voltage lock-out, output over-voltage protection, thermal shutdown, and gate drive under-voltage lock-out. The LMR24210 is available in the small uSMD low profile chip-scale package.

Features

- Input voltage range of 4.5V to 42V
- Output voltage range of 0.8V to 24V
- Output current up to 1.0A
- Integrated low $R_{DS(ON)}$ synchronous MOSFETs for high efficiency
- Up to 1 MHz switching frequency
- Low shutdown I_q , 25 μ A typical
- Programmable soft-start
- No loop compensation required
- COT architecture with ERM
- 28 bump micro SMD (2.45 x 3.64 x 0.60 mm) packaging
- Fully enabled for WEBENCH[®]™ Power Designer

Performance Benefits

- Tiny overall solution reduces system cost
- Integrated synchronous MOSFETs provides high efficiency at low output voltages
- COT with ERM architecture requires no loop compensation, reduces component count, and provides ultra fast transient response
- Stable with low ESR capacitors

Applications

- Point-of-Load Conversions from 5V, 12V and 24V Rails
- Space Constrained Applications
- Industrial Distributed Power Applications
- Power Meters

System Performance

Efficiency vs Load Current
($V_{OUT} = 3.3V$)

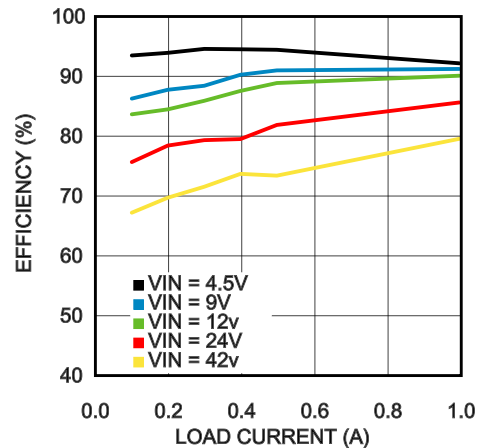

30173870

V_{OUT} Regulation vs Load Current
($V_{OUT} = 3.3V$)

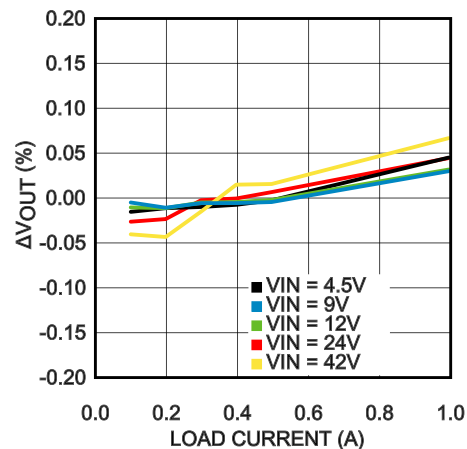

30173871

Typical Application

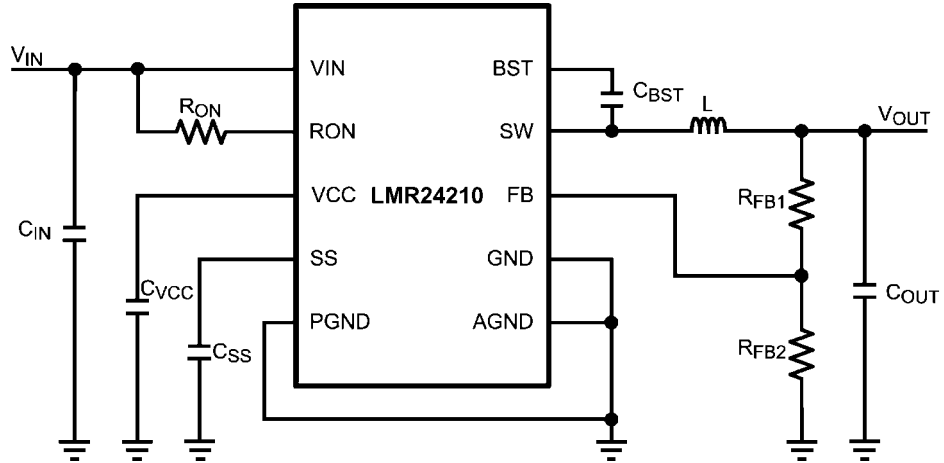

30173801

Connection Diagram

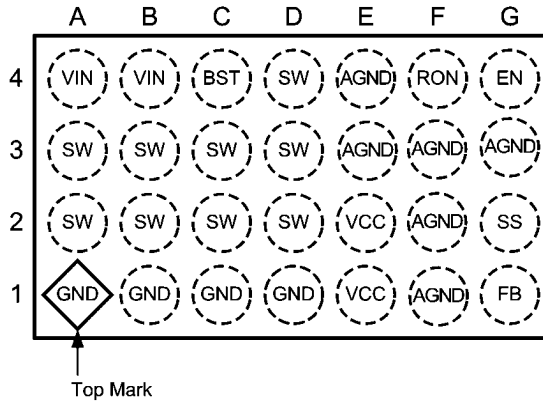

28-ball micro SMD — Balls Facing Down
NS Package Number TLC28VFA

30173869

Ordering Information

Order Number	Package Type	NSC Package Drawing	Supplied As
LMR24210TL	28-ball micro SMD	TLC28VFA	250 Units on Tape and Reel
LMR24210TLX	28-ball micro SMD	TLC28VFA	1000 Units on Tape and Reel

Pin Descriptions

Ball	Name	Description	Application Information
A2, A3, B2, B3, C2, C3, D2, D3, D4	SW	Switching Node	Internally connected to the source of the main MOSFET and the drain of the Synchronous MOSFET. Connect to the inductor.
A4, B4	VIN	Input supply voltage	Supply pin to the device. Nominal input range is 4.5V to 42V.
C4	BST	Connection for bootstrap capacitor	Connect a 33 nF capacitor from the SW pin to this pin. An internal diode charges the capacitor during the main MOSFET off-time.
E3, E4, F1, F2, F3, G3	AGND	Analog Ground	Ground for all internal circuitry other than the PGND pin.
G2	SS	Soft-start	An 8 μ A internal current source charges an external capacitor to provide the soft- start function.
G1	FB	Feedback	Internally connected to the regulation and over-voltage comparators. The regulation setting is 0.8V at this pin. Connect to feedback resistors.
G4	EN	Enable	Connect a voltage higher than 1.26V to enable the regulator. Leaving this input open circuit will enable the device at internal UVLO level.
F4	RON	On-time Control	An external resistor from the VIN pin to this pin sets the main MOSFET on-time.
E1, E2	VCC	Start-up regulator Output	Nominally regulated to 6V. Connect a capacitor of not less than 680 nF between the VCC and AGND pins for stable operation.
A1, B1, C1, D1	GND	Power Ground	Synchronous MOSFET source connection. Tie to a ground plane.

Absolute Maximum Ratings (Note 1)

If Military/Aerospace specified devices are required, please contact the Texas Instruments Sales Office/ Distributors for availability and specifications.

VIN, RON to AGND	-0.3V to 43.5V
SW to AGND	-0.3V to 43.5V
SW to AGND (Transient)	-2V (< 100ns)
VIN to SW	-0.3V to 43.5V
BST to SW	-0.3V to 7V
All Other Inputs to AGND	-0.3V to 7V
ESD Rating (Note 2)	
Human Body Model	±2kV

Storage Temperature Range	-65°C to +150°C
Junction Temperature (T _J)	150°C

Operating Ratings (Note 1)

Supply Voltage Range (VIN)	4.5V to 42V
Junction Temperature Range (T _J)	-40°C to +125°C

Thermal Resistance (θ _{JA}) 28 ball μSMD (Note 5)	50°C/W
---	--------

For soldering specifications: see product folder at www.national.com and www.national.com/ms/MS/MSSOLDERING.pdf

Electrical Characteristics Specifications with standard type are for T_J = 25°C only; limits in **boldface type** apply over the full Operating Junction Temperature (T_J) range. Minimum and Maximum limits are guaranteed through test, design, or statistical correlation. Typical values represent the most likely parametric norm at T_J = 25°C, and are provided for reference purposes only. Unless otherwise stated the following conditions apply: V_{IN} = 18V, V_{OUT} = 3.3V (Note 3).

Symbol	Parameter	Conditions	Min	Typ	Max	Units
Start-Up Regulator, V_{CC}						
V _{CC}	V _{CC} output voltage	C _{CC} = 680nF, no load	5.0	6.0	7.2	V
V _{IN} - V _{CC}	V _{IN} - V _{CC} dropout voltage	I _{CC} = 20mA		350		mV
I _{VCC}	V _{CC} current limit (Note 4)	V _{CC} = 0V	40	65		mA
V _{CC-UVLO}	V _{CC} under-voltage lockout threshold (UVLO)	V _{IN} increasing	3.55	3.75	3.95	V
V _{CC-UVLO-HYS}	V _{CC} UVLO hysteresis	V _{IN} decreasing – μSMD package		150		mV
t _{VCC-UVLO-D}	V _{CC} UVLO filter delay			3		μs
I _{IN}	I _{IN} operating current	No switching, V _{FB} = 1V		0.7	1	mA
I _{IN-SD}	I _{IN} operating current, Device shutdown	V _{EN} = 0V		25	40	μA
Switching Characteristics						
R _{DS-UP-ON}	Main MOSFET R _{DS(on)}			0.18	0.375	Ω
R _{DS-DN-ON}	Syn. MOSFET R _{DS(on)}			0.11	0.225	Ω
V _{G-UVLO}	Gate drive voltage UVLO	V _{BST} - V _{SW} increasing		3.3	4	V
Soft-start						
I _{SS}	SS pin source current	V _{SS} = 0.5V		11		μA
Current Limit						
I _{CL}	Syn. MOSFET current limit threshold	LMR24210	1.2	1.8	2.6	A
ON/OFF Timer						
t _{on}	ON timer pulse width	V _{IN} = 10V, R _{ON} = 100 kΩ		1.38		μs
		V _{IN} = 30V, R _{ON} = 100 kΩ		0.47		
t _{on-MIN}	ON timer minimum pulse width			150		ns
t _{off}	OFF timer pulse width			260		ns
Enable Input						
V _{EN}	EN Pin input threshold	V _{EN} rising	1.13	1.18	1.23	V
V _{EN-HYS}	Enable threshold hysteresis	V _{EN} falling		90		mV
Regulation and Over-Voltage Comparator						
V _{FB}	In-regulation feedback voltage	V _{SS} ≥ 0.8V T _J = -40°C to +125°C	0.784	0.8	0.816	V
V _{FB-OV}	Feedback over-voltage threshold		0.888	0.920	0.945	V
I _{FB}	FB pin current			5		nA
Thermal Shutdown						

Symbol	Parameter	Conditions	Min	Typ	Max	Units
T_{SD}	Thermal shutdown temperature	T_J rising		165		°C
T_{SD-HYS}	Thermal shutdown temperature hysteresis	T_J falling		20		°C

Note 1: Absolute Maximum Ratings are limits beyond which damage to the device may occur. Operating Ratings are conditions under which operation of the device is intended to be functional. For guaranteed specifications and test conditions, see the Electrical Characteristics.

Note 2: The human body model is a 100pF capacitor discharged through a 1.5k Ω resistor into each pin.

Note 3: Min and Max limits are 100% production tested at 25°C. Limits over the operating temperature range are guaranteed through correlation using Statistical Quality Control (SQC) methods. Limits are used to calculate National's Average Outgoing Quality Level (AOQL).

Note 4: V_{CC} provides self bias for the internal gate drive and control circuits. Device thermal limitations limit external loading.

Note 5: θ_{JA} calculations were performed in general accordance with JEDEC standards JESD51-1 to JESD51-11.

Typical Performance Characteristics

Unless otherwise specified all curves are taken at $V_{IN} = 18V$ with the configuration in the typical application circuit for $V_{OUT} = 3.3V$ (Figure 8) $T_A = 25^\circ C$.

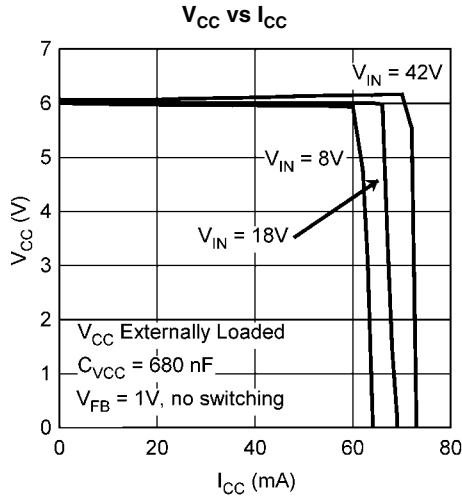

30173804

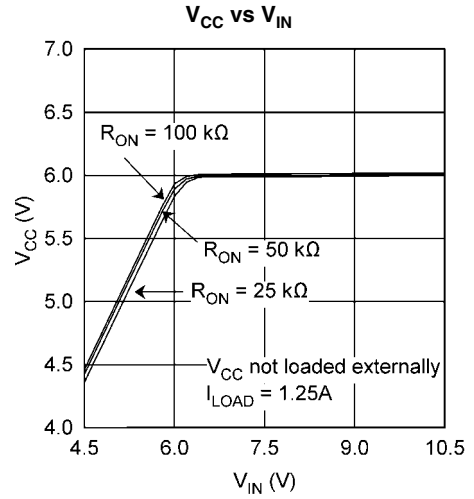

30173805

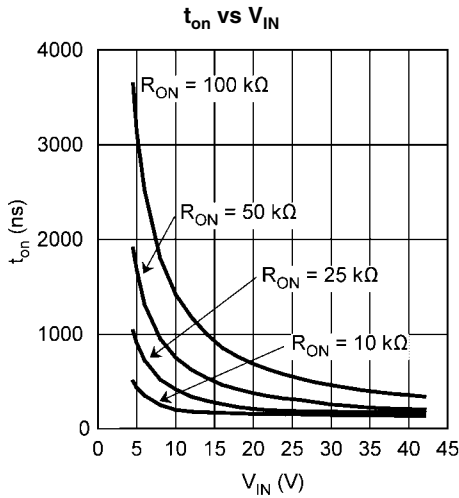

30173806

Switching Frequency, f_{SW} vs V_{IN} , $V_{OUT}=0.8V$,

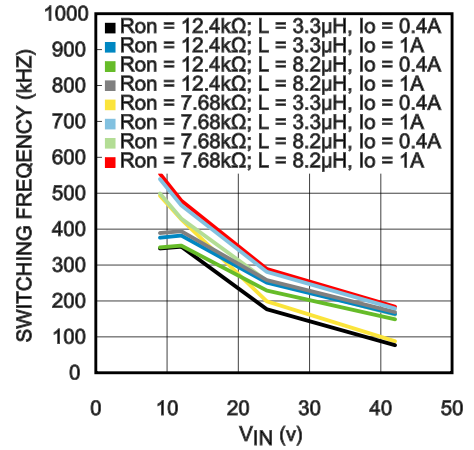

30173875

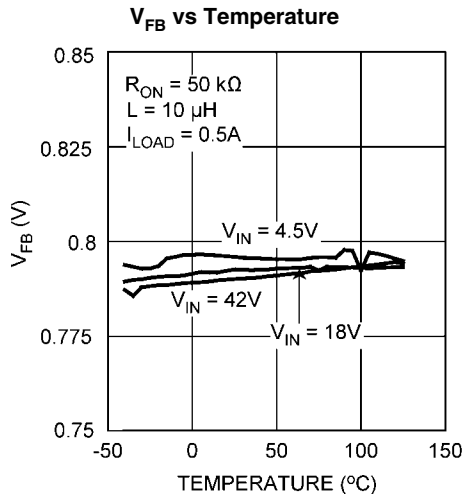

30173808

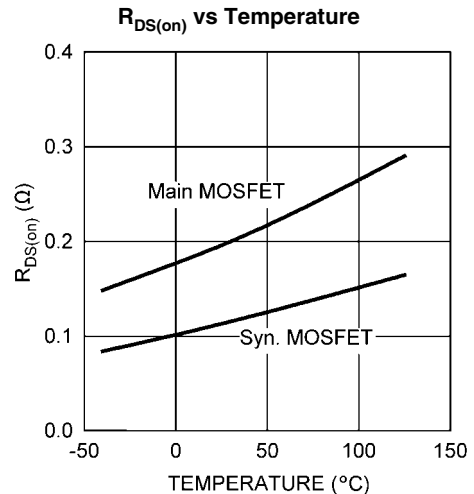

30173809

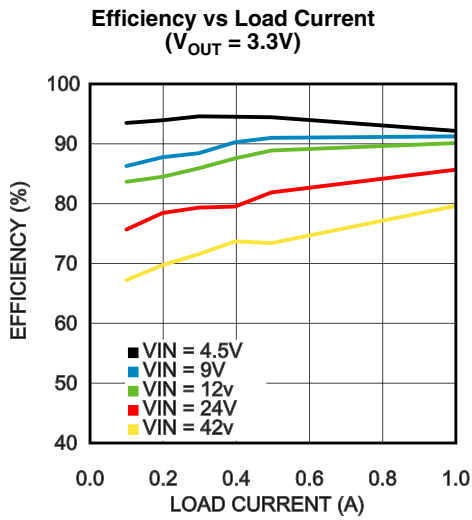

30173870

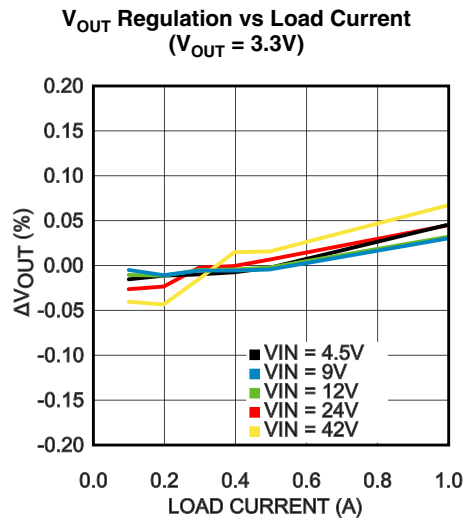

30173871

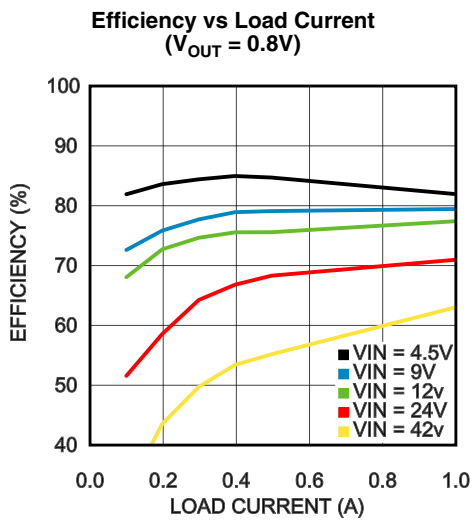

30173872

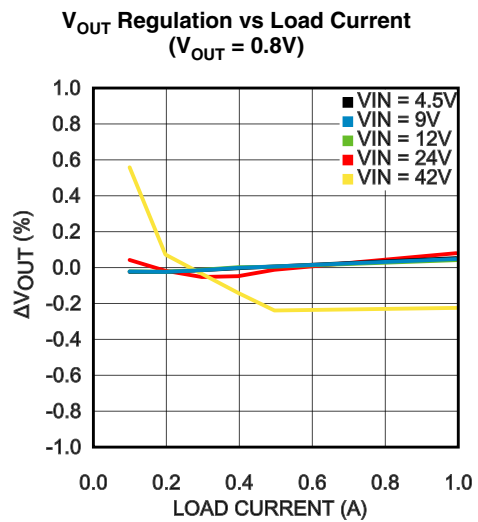

30173873

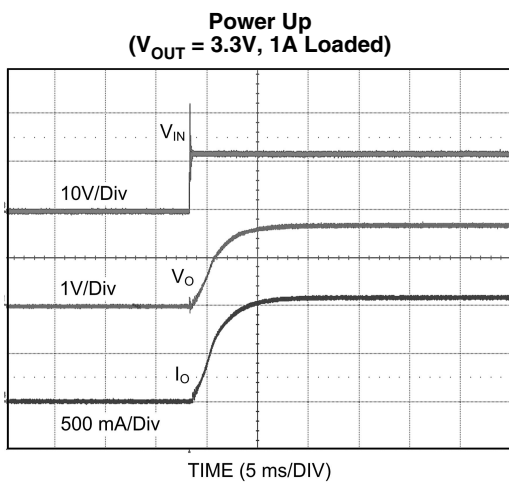

30173876

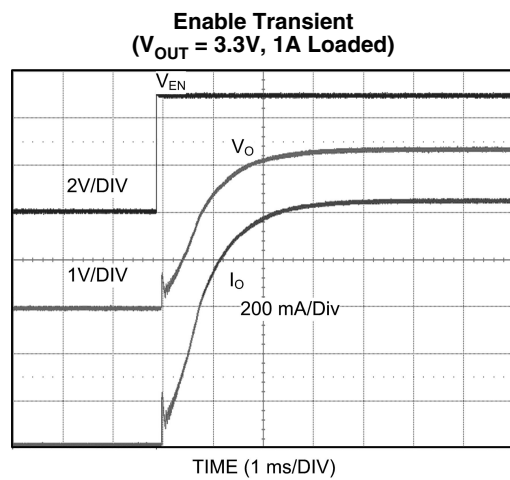

30173814

Shutdown Transient
($V_{OUT} = 3.3V, 1A$ Loaded)

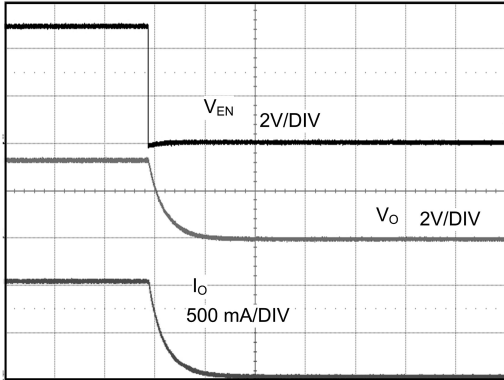

TIME (0.1 ms/DIV)

30173815

Continuous Mode Operation
($V_{OUT} = 3.3V, 1A$ Loaded)

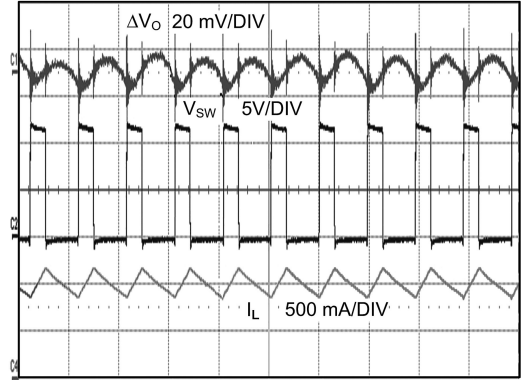

TIME (2 μ s/DIV)

30173816

Discontinuous Mode Operation
($V_{OUT} = 3.3V, 0.050A$ Loaded)

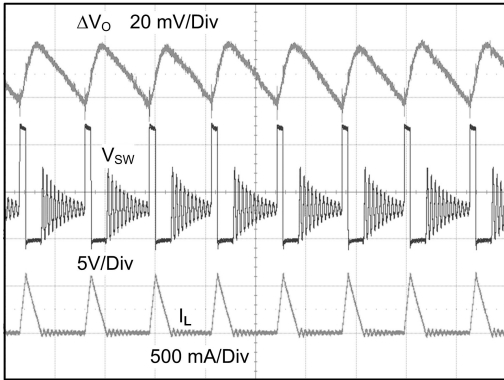

TIME (5 μ s/DIV)

30173817

DCM to CCM Transition
($V_{OUT} = 3.3V, 0.50A - 1A$ Load)

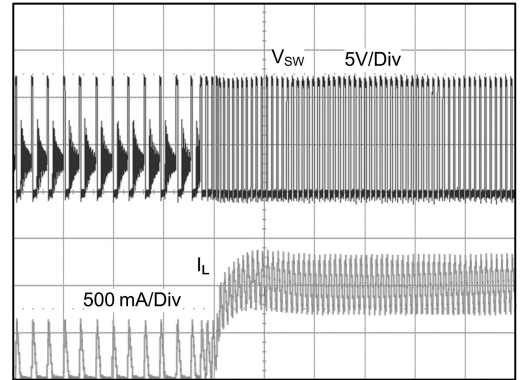

TIME (20 μ s/DIV)

30173818

Load Transient
($V_{OUT} = 3.3V, 0.20A - 1A$ Load,)

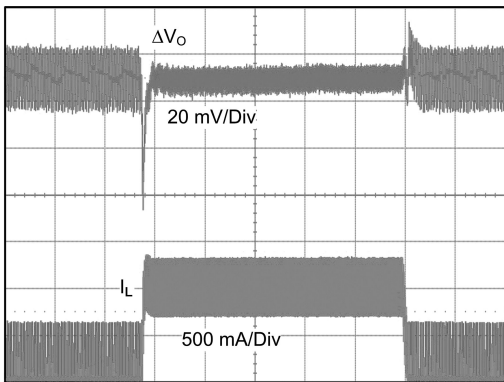

TIME (200 μ s/DIV)

30173819

Functional Description

The LMR24210 Step Down Switching Regulator features all required functions to implement a cost effective, efficient buck power converter capable of supplying 1A to a load. It contains Dual N-Channel main and synchronous MOSFETs. The Constant ON-Time (COT) regulation scheme requires no loop compensation, results in fast load transient response and simple circuit implementation. The regulator can function properly even with an all ceramic output capacitor network, and does not rely on the output capacitor's ESR for stability. The operating frequency remains constant with line variations due to the inverse relationship between the input voltage and the on-time. The valley current limit detection circuit, with the limit set internally at 1.8A, inhibits the main MOSFET until the inductor current level subsides.

The LMR24210 can be applied in numerous applications and can operate efficiently for inputs as high as 42V. Protection features include output over-voltage protection, thermal shut-down, V_{CC} under-voltage lock-out and gate drive under-voltage lock-out. The LMR24210 is available in a small micro SMD chip scale package.

COT Control Circuit Overview

COT control is based on a comparator and a one-shot timer, with the output voltage feedback (feeding to the FB pin) compared with an internal reference of 0.8V. If the voltage of the FB pin is below the reference, the main MOSFET is turned on for a fixed on-time determined by a programming resistor R_{ON} and the input voltage V_{IN} , upon which the on-time varies inversely. Following the on-time, the main MOSFET remains off for a minimum of 260 ns. Then, if the voltage of the FB pin is below the reference, the main MOSFET is turned on again for another on-time period. The switching will continue to achieve regulation.

The regulator will operate in the discontinuous conduction mode (DCM) at a light load, and the continuous conduction mode (CCM) with a heavy load. In the DCM, the current through the inductor starts at zero and ramps up to a peak during the on-time, and then ramps back to zero before the end of the off-time. It remains zero and the load current is supplied entirely by the output capacitor. The next on-time period starts when the voltage at the FB pin falls below the internal reference. The operating frequency in the DCM is lower and varies larger with the load current as compared with the CCM. Conversion efficiency is maintained since conduction loss and switching loss are reduced with the reduction in the load and the switching frequency respectively. The operating frequency in the DCM can be calculated approximately as follows:

$$f_{SW} = \frac{V_{OUT} (V_{IN} - 1) \times L \times 1.18 \times 10^{20} \times I_{OUT}}{(V_{IN} - V_{OUT}) \times R_{ON}^2} \quad (1)$$

In the continuous conduction mode (CCM), the current flows through the inductor in the entire switching cycle, and never reaches zero during the off-time. The operating frequency remains relatively constant with load and line variations. The CCM operating frequency can be calculated approximately as follows:

$$f_{SW} = \frac{V_{OUT}}{1.3 \times 10^{-10} \times R_{ON}} \quad (2)$$

Please consider equation number (4) and (5) when choosing the switching frequency.

The output voltage is set by two external resistors R_{FB1} and R_{FB2} . The regulated output voltage is

$$V_{OUT} = 0.8V \times (R_{FB1} + R_{FB2})/R_{FB2} \quad (3)$$

Startup Regulator (V_{CC})

A startup regulator is integrated within the LMR24210. The input pin V_{IN} can be connected directly to a line voltage up to 42V. The V_{CC} output regulates at 6V, and is current limited to 65 mA. Upon power up, the regulator sources current into an external capacitor C_{VCC} , which is connected to the V_{CC} pin. For stability, C_{VCC} must be at least 680 nF. When the voltage on the V_{CC} pin is higher than the under-voltage lock-out (UV-LO) threshold of 3.75V, the main MOSFET is enabled and the SS pin is released to allow the soft-start capacitor C_{SS} to charge.

The minimum input voltage is determined by the dropout voltage of the regulator and the V_{CC} UVLO falling threshold ($\approx 3.7V$). If V_{IN} is less than $\approx 4.0V$, the regulator shuts off and V_{CC} goes to zero.

Regulation Comparator

The feedback voltage at the FB pin is compared to a 0.8V internal reference. In normal operation (the output voltage is regulated), an on-time period is initiated when the voltage at the FB pin falls below 0.8V. The main MOSFET stays on for the on-time, causing the output voltage and consequently the voltage of the FB pin to rise above 0.8V. After the on-time period, the main MOSFET stays off until the voltage of the FB pin falls below 0.8V again. Bias current at the FB pin is nominally 5 nA.

Zero Coil Current Detect

The current of the synchronous MOSFET is monitored by a zero coil current detection circuit which inhibits the synchronous MOSFET when its current reaches zero until the next on-time. This circuit enables the DCM operation, which improves the efficiency at a light load.

Over-Voltage Comparator

The voltage at the FB pin is compared to a 0.92V internal reference. If it rises above 0.92V, the on-time is immediately terminated. This condition is known as over-voltage protection (OVP). It can occur if the input voltage or the output load changes suddenly. Once the OVP is activated, the main MOSFET remains off until the voltage at the FB pin falls below 0.92V. The synchronous MOSFET will stay on to discharge the inductor until the inductor current reduces to zero, and then switches off.

ON-Time Timer, Shutdown

The on-time of the LMR24210 main MOSFET is determined by the resistor R_{ON} and the input voltage V_{IN} . It is calculated as follows:

$$t_{on} = \frac{1.3 \times 10^{-10} \times R_{ON}}{V_{IN}} \quad (4)$$

The inverse relationship of t_{on} and V_{IN} gives a nearly constant frequency as V_{IN} is varied. R_{ON} should be selected such that the on-time at maximum V_{IN} is greater than 150 ns. The on-timer has a limiter to ensure a minimum of 150 ns for t_{on} . This

limits the maximum operating frequency, which is governed by the following equation:

$$f_{SW(MAX)} = \frac{V_{OUT}}{V_{IN(MAX)} \times 150 \text{ ns}} \quad (5)$$

The LMR24210 can be remotely shutdown by pulling the voltage of the EN pin below 1V. In this shutdown mode, the SS pin is internally grounded, the on-timer is disabled, and bias currents are reduced. Releasing the EN pin allows normal operation to resume because the EN pin is internally pulled up.

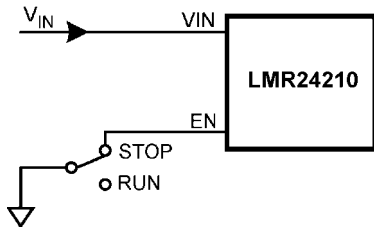

30173825

FIGURE 1. Shutdown Implementation

Current Limit

Current limit detection is carried out during the off-time by monitoring the re-circulating current through the synchronous

MOSFET. Referring to the Functional Block Diagram, when the main MOSFET is turned off, the inductor current flows through the load, the PGND pin and the internal synchronous MOSFET. If this current exceeds 1.8A, the current limit comparator toggles, and as a result disabling the start of the next on-time period. The next switching cycle starts when the re-circulating current falls back below 1.8A (and the voltage at the FB pin is below 0.8V). The inductor current is monitored during the on-time of the synchronous MOSFET. As long as the inductor current exceeds 1.8A, the main MOSFET will remain inhibited to achieve current limit. The operating frequency is lower during current limit due to a longer off-time.

Figure 2 illustrates an inductor current waveform. On average, the output current I_{OUT} is the same as the inductor current I_L , which is the average of the rippled inductor current. In case of current limit (the current limit portion of Figure 2), the next on-time will not initiate until the current drops below 1.8A (assume the voltage at the FB pin is lower than 0.8V). During each on-time the current ramps up an amount equal to:

$$I_{LR} = \frac{(V_{IN} - V_{OUT}) \times t_{on}}{L} \quad (6)$$

During current limit, the LMR24210 operates in a constant current mode with an average output current $I_{OUT(CL)}$ equal to $1.8A + I_{LR} / 2$.

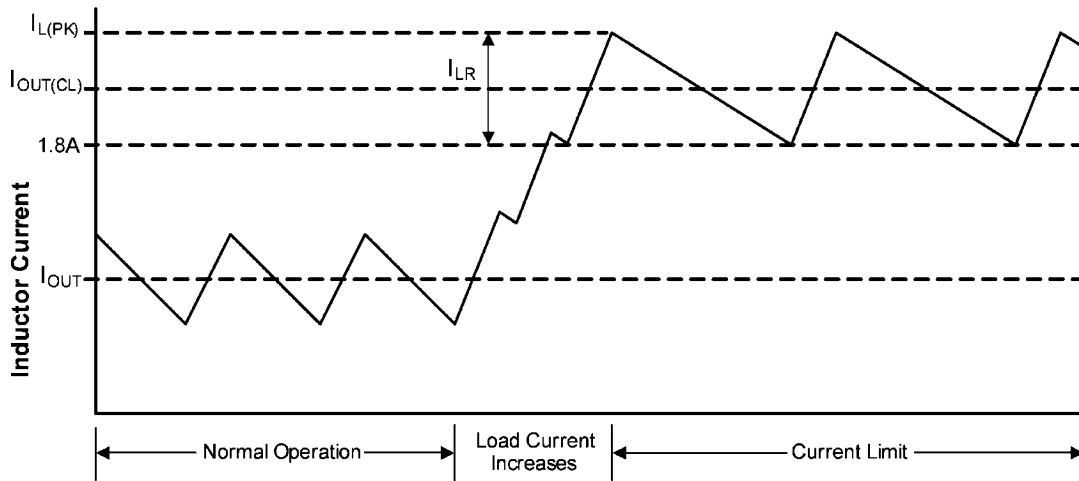

30173826

FIGURE 2. Inductor Current - Current Limit Operation

N-Channel MOSFET and Driver

The LMR24210 integrates an N-Channel main MOSFET and an associated floating high voltage main MOSFET gate driver. The gate drive circuit works in conjunction with an external bootstrap capacitor C_{BST} and an internal high voltage diode. C_{BST} connecting between the BST and SW pins powers the main MOSFET gate driver during the main MOSFET on-time. During each off-time, the voltage of the SW pin falls to approximately -1V, and C_{BST} charges from V_{CC} through the internal diode. The minimum off-time of 260 ns provides enough time for charging C_{BST} in each cycle.

Soft-Start

The soft-start feature allows the converter to gradually reach a steady state operating point, thereby reducing startup stresses and current surges. Upon turn-on, after V_{CC} reaches the under-voltage threshold, an 8 μ A internal current source charges up an external capacitor C_{SS} connecting to the SS pin. The ramping voltage at the SS pin (and the non-inverting input of the regulation comparator as well) ramps up the output voltage V_{OUT} in a controlled manner.

The soft start time duration to reach steady state operation is given by the formula:

$$t_{SS} = V_{REF} \times C_{SS} = 0.8V \times C_{SS} / 8\mu A$$

This equation can be rearranged as follows:

$$C_{SS} = t_{SS} \times 8\mu A / 0.8V$$

Use of a 4.7nF capacitor results in a 0.5ms soft-start duration. This is a recommended value. Note that high values of C_{SS} capacitance will cause more output voltage drop when a load transient goes across the DCM-CCM boundary. If a fast load transient response is desired for steps between DCM and CCM mode the softstart capacitor value should be less than 18nF (which corresponds to a soft-start time of 1.8ms).

An internal switch grounds the SS pin if any of the following three cases happens: (i) V_{CC} is below the under-voltage lock-out threshold; (ii) a thermal shutdown occurs; or (iii) the EN pin is grounded. Alternatively, the output voltage can be shut off by connecting the SS pin to ground using an external switch. Releasing the switch allows the SS pin to ramp up and the output voltage to return to normal. The shutdown configuration is shown in Figure 3.

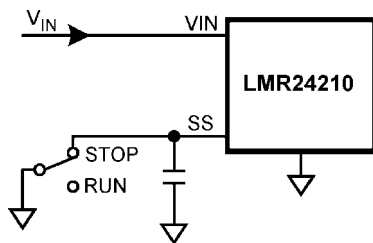

30173827

FIGURE 3. Alternate Shutdown Implementation

Thermal Protection

The junction temperature of the LMR24210 should not exceed the maximum limit. Thermal protection is implemented by an internal Thermal Shutdown circuit, which activates (typically) at 165°C to make the controller enter a low power reset state by disabling the main MOSFET, disabling the on-timer, and grounding the SS pin. Thermal protection helps prevent catastrophic failures from accidental device overheating. When the junction temperature falls back below 145°C (typical hysteresis = 20°C), the SS pin is released and normal operation resumes.

Thermal Derating

Temperature rise increases with frequency, load current, input voltage and smaller board dimensions. On a typical board, the LMR24210 is capable of supplying 1A below an ambient temperature of 90°C under worst case operation with input voltage of 42V. Figure 4 shows a thermal derating curve for the output current without thermal shutdown against ambient temperature up to 125°C. Obtaining 1A output current is possible at higher temperature by increasing the PCB ground plane area, adding airflow or reducing the input voltage or operating frequency.

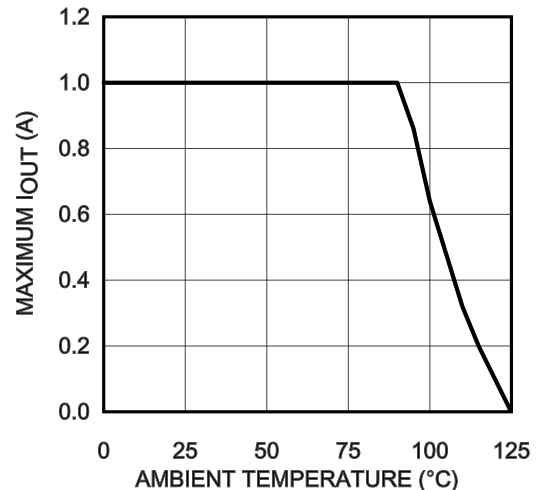

30173874

FIGURE 4. Thermal Derating Curve, $\theta_{JA}=40^{\circ}\text{C}/\text{W}$, $V_o = 3.3\text{V}$, $f_s = 500\text{kHz}$ (tested on the evaluation board)

Applications Information

EXTERNAL COMPONENTS

The following guidelines can be used to select external components.

R_{FB1} and R_{FB2}: These resistors should be chosen from standard values in the range of 1.0 kΩ to 10 kΩ, satisfying the following ratio:

$$R_{FB1}/R_{FB2} = (V_{OUT}/0.8V) - 1 \quad (7)$$

For $V_{OUT} = 0.8V$, the FB pin can be connected to the output directly with a pre-load resistor drawing more than 20 μA. This is needed because the converter operation needs a minimum inductor current ripple to maintain good regulation when no load is connected.

R_{ON}: Equation (2) can be used to select R_{ON} if a desired operating frequency is selected. But the minimum value of R_{ON} is determined by the minimum on-time. It can be calculated as follows:

$$R_{ON} \geq \frac{V_{IN(MAX)} \times 150 \text{ ns}}{1.3 \times 10^{-10}} \quad (8)$$

If R_{ON} calculated from (2) is smaller than the minimum value determined in (8), a lower frequency should be selected to recalculate R_{ON} by (2). Alternatively, V_{IN(MAX)} can also be limited in order to keep the frequency unchanged. The relationship of V_{IN(MAX)} and R_{ON} is shown in [Figure 5](#).

On the other hand, the minimum off-time of 260 ns can limit the maximum duty ratio.

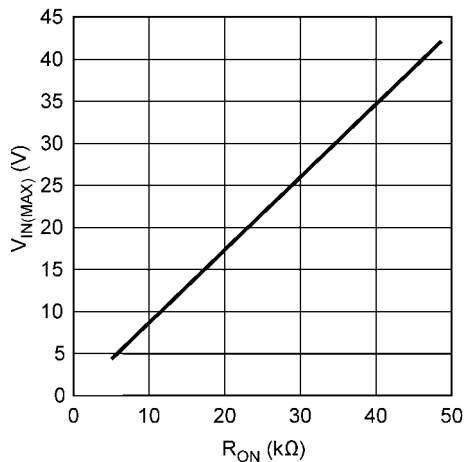

30173829

FIGURE 5. Maximum V_{IN} for selected R_{ON}

L: The main parameter affected by the inductor is the amplitude of inductor current ripple (I_{LR}). Once I_{LR} is selected, L can be determined by:

$$L = \frac{V_{OUT} \times (V_{IN} - V_{OUT})}{I_{LR} \times f_{SW} \times V_{IN}} \quad (9)$$

where V_{IN} is the maximum input voltage and f_{SW} is determined from (2).

If the output current I_{OUT} is determined, by assuming that I_{OUT} = I_L, the higher and lower peak of I_{LR} can be determined. Beware that the higher peak of I_{LR} should not be larger than

the saturation current of the inductor and current limits of the main and synchronous MOSFETs. Also, the lower peak of I_{LR} must be positive if CCM operation is required.

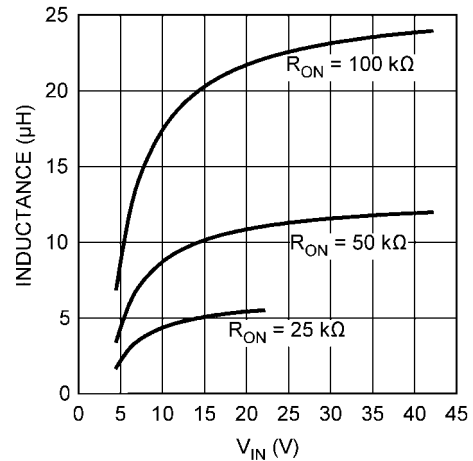

30173831

FIGURE 6. Inductor selection for V_{OUT} = 3.3V

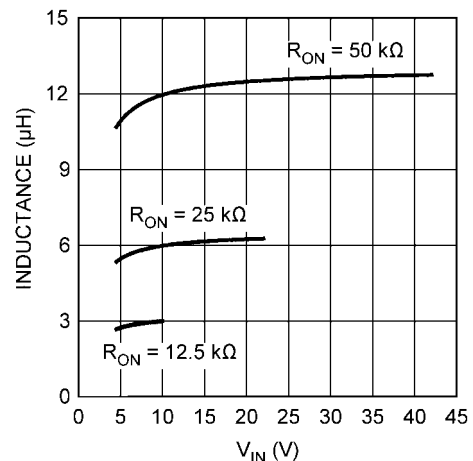

30173832

FIGURE 7. Inductor selection for V_{OUT} = 0.8V

[Figure 6](#) and [Figure 7](#) show curves on inductor selection for various V_{OUT} and R_{ON}. For small R_{ON}, according to (8), V_{IN} is limited. Some curves are therefore limited as shown in the figures.

C_{VCC}: The capacitor on the V_{CC} output provides not only noise filtering and stability, but also prevents false triggering of the V_{CC} UVLO at the main MOSFET on/off transitions. C_{VCC} should be no smaller than 680 nF for stability, and should be a good quality, low ESR, ceramic capacitor.

C_{OUT} and C_{OUT3}: C_{OUT} should generally be no smaller than 10 μF. Experimentation is usually necessary to determine the minimum value for C_{OUT}, as the nature of the load may require a larger value. A load which creates significant transients requires a larger C_{OUT} than a fixed load.

C_{OUT3} is a small value ceramic capacitor located close to the LMR24210 to further suppress high frequency noise at V_{OUT}. A 100 nF capacitor is recommended.

C_{IN} and C_{IN3}: The function of C_{IN} is to supply most of the main MOSFET current during the on-time, and limit the voltage rip-

ple at the VIN pin, assuming that the voltage source connecting to the VIN pin has finite output impedance. If the voltage source's dynamic impedance is high (effectively a current source), C_{IN} supplies the average input current, but not the ripple current.

At the maximum load current, when the main MOSFET turns on, the current to the VIN pin suddenly increases from zero to the lower peak of the inductor's ripple current and ramps up to the higher peak value. It then drops to zero at turn-off. The average current during the on-time is the load current. For a worst case calculation, C_{IN} must be capable of supplying this average load current during the maximum on-time. C_{IN} is calculated from:

$$C_{IN} = \frac{I_{OUT} \times t_{on}}{\Delta V_{IN}} \quad (10)$$

where I_{OUT} is the load current, t_{on} is the maximum on-time, and ΔV_{IN} is the allowable ripple voltage at V_{IN} .

C_{IN3} 's purpose is to help avoid transients and ringing due to long lead inductance at the VIN pin. A low ESR 0.1 μ F ceramic chip capacitor located close to the LMR24210 is recommended.

C_{BST} : A 33 nF high quality ceramic capacitor with low ESR is recommended for C_{BST} since it supplies a surge current to charge the main MOSFET gate driver at turn-on. Low ESR also helps ensure a complete recharge during each off-time.

C_{SS} : The capacitor at the SS pin determines the soft-start time, i.e. the time for the reference voltage at the regulation comparator and the output voltage to reach their final value. The time is determined from the following equation:

$$t_{SS} = \frac{C_{SS} \times 0.8V}{8 \mu A} \quad (11)$$

C_{FB} : If the output voltage is higher than 1.6V, C_{FB} is needed in the Discontinuous Conduction Mode to reduce the output ripple. The recommended value for C_{FB} is 10 nF.

PC BOARD LAYOUT

The LMR24210 regulation, over-voltage, and current limit comparators are very fast and may respond to short duration noise pulses. Layout is therefore critical for optimum performance. It must be as neat and compact as possible, and all external components must be as close to their associated pins of the LMR24210 as possible. Refer to the functional block diagram, the loop formed by C_{IN} , the main and synchronous MOSFET internal to the LMR24210, and the PGND pin should be as small as possible. The connection from the PGND pin to C_{IN} should be as short and direct as possible. Vias should be added to connect the ground of C_{IN} to a ground plane, located as close to the capacitor as possible. The bootstrap capacitor C_{BST} should be connected as close to the SW and BST pins as possible, and the connecting traces should be thick. The feedback resistors and capacitor R_{FB1} , R_{FB2} , and C_{FB} should be close to the FB pin. A long trace running from V_{OUT} to R_{FB1} is generally acceptable since this is a low impedance node. Ground R_{FB2} directly to the AGND pin. The output capacitor C_{OUT} should be connected close to the load and tied directly to the ground plane. The inductor L should be connected close to the SW pin with as short a trace as possible to reduce the potential for EMI (electromagnetic interference) generation. If it is expected that the internal dissipation of the LMR24210 will produce excessive junction temperature during normal operation, making good use of the PC board's ground plane can help considerably to dissipate heat. Additionally the use of thick traces, where possible, can help conduct heat away from the LMR24210. Judicious positioning of the PC board within the end product, along with the use of any available air flow (forced or natural convection) can help reduce the junction temperature.

Package Considerations

The die has exposed edges and can be sensitive to ambient light. For applications with direct high intensity ambient red, infrared, LED or natural light it is recommended to have the device shielded from the light source to avoid abnormal behavior.

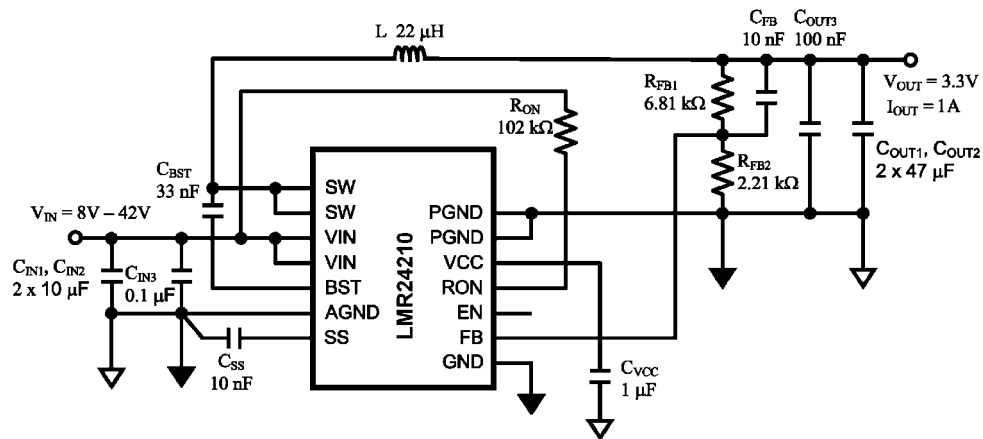

30173835

FIGURE 8. Typical Application Schematic for $V_{OUT} = 3.3V$

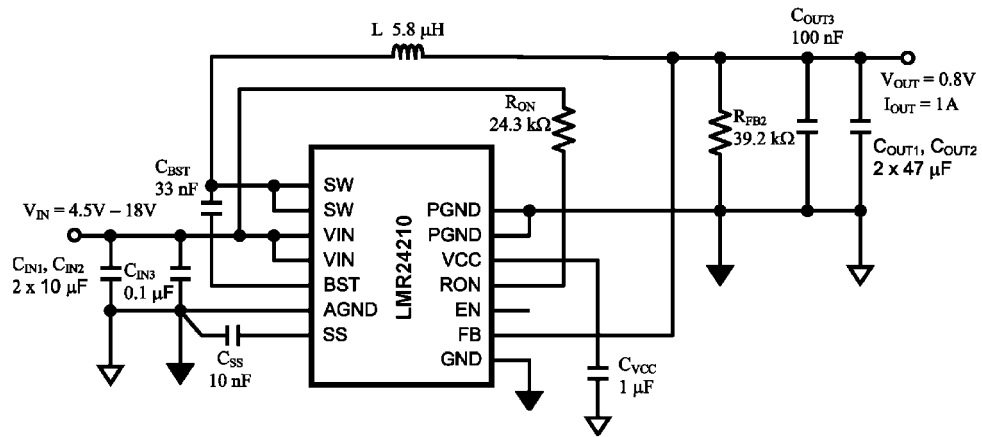

30173836

FIGURE 9. Typical Application Schematic for $V_{OUT} = 0.8V$

Physical Dimensions inches (millimeters) unless otherwise noted

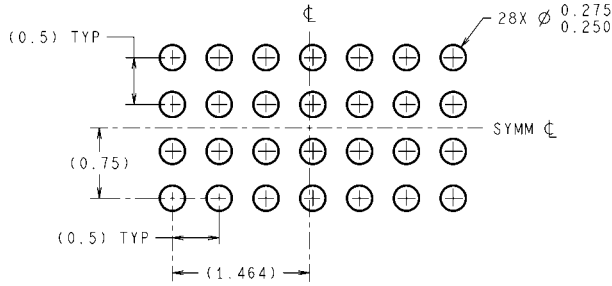

LAND PATTERN RECOMMENDATION

DIMENSIONS ARE IN MILLIMETERS
DIMENSIONS IN () FOR REFERENCE ONLY

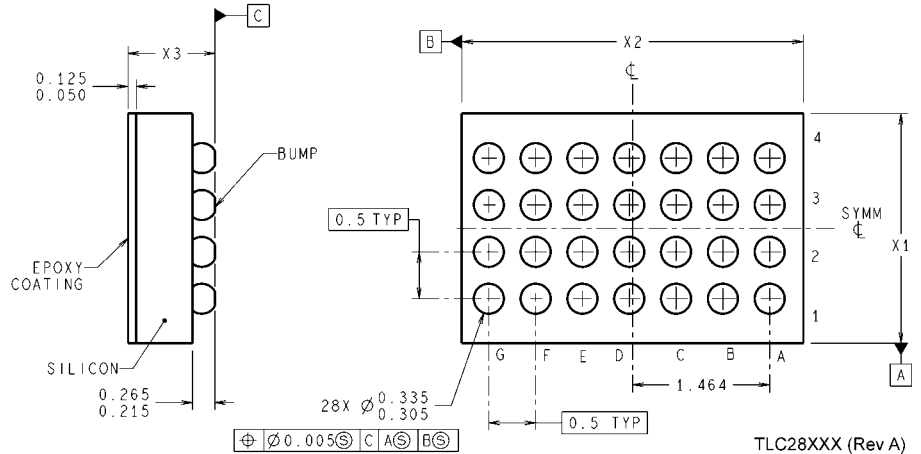
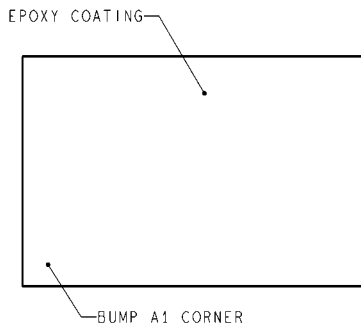

TLC28XXX (Rev A)

28-Ball μSMD
NS Package Number TLC28VFA
X1 = 2449 +/- 30 μm
X2 = 3643 +/- 30 μm
X3 = 600 +/- 75 μm

Notes

Notes

IMPORTANT NOTICE

Texas Instruments Incorporated and its subsidiaries (TI) reserve the right to make corrections, modifications, enhancements, improvements, and other changes to its products and services at any time and to discontinue any product or service without notice. Customers should obtain the latest relevant information before placing orders and should verify that such information is current and complete. All products are sold subject to TI's terms and conditions of sale supplied at the time of order acknowledgment.

TI warrants performance of its hardware products to the specifications applicable at the time of sale in accordance with TI's standard warranty. Testing and other quality control techniques are used to the extent TI deems necessary to support this warranty. Except where mandated by government requirements, testing of all parameters of each product is not necessarily performed.

TI assumes no liability for applications assistance or customer product design. Customers are responsible for their products and applications using TI components. To minimize the risks associated with customer products and applications, customers should provide adequate design and operating safeguards.

TI does not warrant or represent that any license, either express or implied, is granted under any TI patent right, copyright, mask work right, or other TI intellectual property right relating to any combination, machine, or process in which TI products or services are used. Information published by TI regarding third-party products or services does not constitute a license from TI to use such products or services or a warranty or endorsement thereof. Use of such information may require a license from a third party under the patents or other intellectual property of the third party, or a license from TI under the patents or other intellectual property of TI.

Reproduction of TI information in TI data books or data sheets is permissible only if reproduction is without alteration and is accompanied by all associated warranties, conditions, limitations, and notices. Reproduction of this information with alteration is an unfair and deceptive business practice. TI is not responsible or liable for such altered documentation. Information of third parties may be subject to additional restrictions.

Resale of TI products or services with statements different from or beyond the parameters stated by TI for that product or service voids all express and any implied warranties for the associated TI product or service and is an unfair and deceptive business practice. TI is not responsible or liable for any such statements.

TI products are not authorized for use in safety-critical applications (such as life support) where a failure of the TI product would reasonably be expected to cause severe personal injury or death, unless officers of the parties have executed an agreement specifically governing such use. Buyers represent that they have all necessary expertise in the safety and regulatory ramifications of their applications, and acknowledge and agree that they are solely responsible for all legal, regulatory and safety-related requirements concerning their products and any use of TI products in such safety-critical applications, notwithstanding any applications-related information or support that may be provided by TI. Further, Buyers must fully indemnify TI and its representatives against any damages arising out of the use of TI products in such safety-critical applications.

TI products are neither designed nor intended for use in military/aerospace applications or environments unless the TI products are specifically designated by TI as military-grade or "enhanced plastic." Only products designated by TI as military-grade meet military specifications. Buyers acknowledge and agree that any such use of TI products which TI has not designated as military-grade is solely at the Buyer's risk, and that they are solely responsible for compliance with all legal and regulatory requirements in connection with such use.

TI products are neither designed nor intended for use in automotive applications or environments unless the specific TI products are designated by TI as compliant with ISO/TS 16949 requirements. Buyers acknowledge and agree that, if they use any non-designated products in automotive applications, TI will not be responsible for any failure to meet such requirements.

Following are URLs where you can obtain information on other Texas Instruments products and application solutions:

Products

Audio	www.ti.com/audio
Amplifiers	amplifier.ti.com
Data Converters	dataconverter.ti.com
DLP® Products	www.dlp.com
DSP	dsp.ti.com
Clocks and Timers	www.ti.com/clocks
Interface	interface.ti.com
Logic	logic.ti.com
Power Mgmt	power.ti.com
Microcontrollers	microcontroller.ti.com
RFID	www.ti-rfid.com
OMAP Mobile Processors	www.ti.com/omap
Wireless Connectivity	www.ti.com/wirelessconnectivity

Applications

Automotive and Transportation	www.ti.com/automotive
Communications and Telecom	www.ti.com/communications
Computers and Peripherals	www.ti.com/computers
Consumer Electronics	www.ti.com/consumer-apps
Energy and Lighting	www.ti.com/energy
Industrial	www.ti.com/industrial
Medical	www.ti.com/medical
Security	www.ti.com/security
Space, Avionics and Defense	www.ti.com/space-avionics-defense
Video and Imaging	www.ti.com/video

TI E2E Community Home Page

e2e.ti.com

Mailing Address: Texas Instruments, Post Office Box 655303, Dallas, Texas 75265
Copyright © 2012, Texas Instruments Incorporated