

TVS Diodes

Transient Voltage Suppressor Diodes

ESD102-U1-02ELS

Uni-directional Ultra-low Capacitance ESD / Transient Protection Diode

ESD102-U1-02ELS

Data Sheet

Revision 1.0, 2013-02-04
Final

Edition 2013-02-04

**Published by
Infineon Technologies AG
81726 Munich, Germany**

**© 2013 Infineon Technologies AG
All Rights Reserved.**

Legal Disclaimer

The information given in this document shall in no event be regarded as a guarantee of conditions or characteristics. With respect to any examples or hints given herein, any typical values stated herein and/or any information regarding the application of the device, Infineon Technologies hereby disclaims any and all warranties and liabilities of any kind, including without limitation, warranties of non-infringement of intellectual property rights of any third party.

Information

For further information on technology, delivery terms and conditions and prices, please contact the nearest Infineon Technologies Office (www.infineon.com).

Warnings

Due to technical requirements, components may contain dangerous substances. For information on the types in question, please contact the nearest Infineon Technologies Office.

Infineon Technologies components may be used in life-support devices or systems only with the express written approval of Infineon Technologies, if a failure of such components can reasonably be expected to cause the failure of that life-support device or system or to affect the safety or effectiveness of that device or system. Life support devices or systems are intended to be implanted in the human body or to support and/or maintain and sustain and/or protect human life. If they fail, it is reasonable to assume that the health of the user or other persons may be endangered.

Revision History: Revision 0.9.1, 2012-07-27

Page or Item	Subjects (major changes since previous revision)
Revision 1.0, 2013-02-04	
All	Status change to Final

Trademarks of Infineon Technologies AG

AURIX™, BlueMoon™, COMNEON™, C166™, CROSSAVE™, CanPAK™, CIPOS™, CoolMOS™, CoolSET™, CORECONTROL™, DAVE™, EasyPIM™, EconoBRIDGE™, EconoDUAL™, EconoPACK™, EconoPIM™, EiceDRIVER™, EUPEC™, FCOS™, HITFET™, HybridPACK™, ISOFACE™, I²RF™, IsoPACK™, MIPAQ™, ModSTACK™, my-d™, NovalithIC™, OmniTune™, OptiMOS™, ORIGA™, PROFET™, PRO-SIL™, PRIMARION™, PrimePACK™, RASIC™, ReverSave™, SatRIC™, SIEGET™, SINDRION™, SMARTi™, SmartLEWIS™, TEMPFET™, thinQ!™, TriCore™, TRENCHSTOP™, X-GOLD™, XMM™, X-PMU™, XPOSYS™.

Other Trademarks

Advance Design System™ (ADS) of Agilent Technologies, AMBA™, ARM™, MULTI-ICE™, PRIMECELL™, REALVIEW™, THUMB™ of ARM Limited, UK. AUTOSAR™ is licensed by AUTOSAR development partnership. Bluetooth™ of Bluetooth SIG Inc. CAT-iq™ of DECT Forum. COLOSSUS™, FirstGPS™ of Trimble Navigation Ltd. EMV™ of EMVCo, LLC (Visa Holdings Inc.). EPCOS™ of Epcos AG. FLEXGO™ of Microsoft Corporation. FlexRay™ is licensed by FlexRay Consortium. HYPERTERMINAL™ of Hilgraeve Incorporated. IEC™ of Commission Electrotechnique Internationale. IrDA™ of Infrared Data Association Corporation. ISO™ of INTERNATIONAL ORGANIZATION FOR STANDARDIZATION. MATLAB™ of MathWorks, Inc. MAXIM™ of Maxim Integrated Products, Inc. MICROTEC™, NUCLEUS™ of Mentor Graphics Corporation. Mifare™ of NXP. MIPI™ of MIPI Alliance, Inc. MIPS™ of MIPS Technologies, Inc., USA. muRata™ of MURATA MANUFACTURING CO., MICROWAVE OFFICE™ (MWO) of Applied Wave Research Inc., OmniVision™ of OmniVision Technologies, Inc. Openwave™ Openwave Systems Inc. RED HAT™ Red Hat, Inc. RFMD™ RF Micro Devices, Inc. SIRIUS™ of Sirius Sattelite Radio Inc. SOLARIS™ of Sun Microsystems, Inc. SPANSION™ of Spansion LLC Ltd. Symbian™ of Symbian Software Limited. TAIYO YUDEN™ of Taiyo Yuden Co. TEAKLITE™ of CEVA, Inc. TEKTRONIX™ of Tektronix Inc. TOKO™ of TOKO KABUSHIKI KAISHA TA. UNIX™ of X/Open Company Limited. VERILOG™, PALLADIUM™ of Cadence Design Systems, Inc. VLYNQ™ of Texas Instruments Incorporated. VXWORKS™, WIND RIVER™ of WIND RIVER SYSTEMS, INC. ZETEX™ of Diodes Zetex Limited.

Last Trademarks Update 2010-06-09

1 Uni-directional Ultra-low Capacitance ESD / Transient Protection Diode

1.1 Features

- ESD / Transient protection of high speed data lines exceeding
 - IEC61000-4-2 (ESD): ± 20 kV (air / contact)
 - IEC61000-4-4 (EFT): ± 2.5 kV / 50 A (5/50 ns)
 - IEC61000-4-5 (surge): ± 3 A (8/20 μ s)
- Maximum working voltage: $V_{RWM} = 3.3$ V
- Ultra low capacitance $C_L = 0.4$ pF (typical)
- Very low clamping voltage: $V_{CL} = 8$ V (typical) at $I_{PP} = 16$ A [2]
- Very low dynamic resistance: $R_{DYN} = 0.19$ Ω (typical) [2]
- Pb-free (RoHS compliant) and halogen free package, very small form factor 0.62 x 0.32 x 0.31 mm³



1.2 Application Examples

- USB 3.0, 10/100/1000 Ethernet, Firewire, DVI, HDMI, S-ATA, DisplayPort
- Mobile HDMI Link, MDDI, MIPI, SWP / NFC

1.3 Product Description

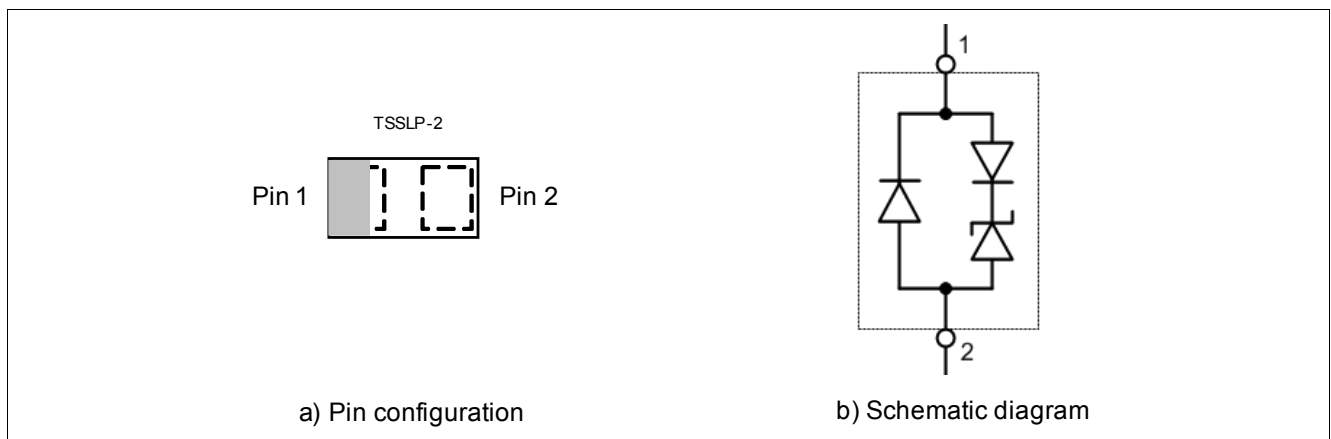

Figure 1 Pin Configuration and Schematic Diagram

Table 1 Ordering Information

Type	Package	Configuration	Marking code
ESD102-U1-02ELS	TSSLP-2-3	1 line, uni-directional	<u>E</u>

2 Characteristics

Table 2 Maximum Rating at $T_A = 25\text{ }^\circ\text{C}$, unless otherwise specified

Parameter	Symbol	Values			Unit
		Min.	Typ.	Max.	
ESD (air / contact) discharge ¹⁾	V_{ESD}	-20	–	20	kV
Peak pulse current ($t_p = 8/20\text{ }\mu\text{s}$) ²⁾	I_{PP}	-3	–	3	A
Operating temperature range	T_{OP}	-40	–	125	$^\circ\text{C}$
Storage temperature	T_{stg}	-65	–	150	$^\circ\text{C}$

1) V_{ESD} according to IEC61000-4-2 ($R = 330\text{ }\Omega$, $C = 150\text{ pF}$)

2) I_{PP} according to IEC61000-4-5

Attention: Stresses above the max. values listed here may cause permanent damage to the device. Exposure to absolute maximum rating conditions for extended periods may affect device reliability. Maximum ratings are absolute ratings; exceeding only one of these values may cause irreversible damage to the integrated circuit.

2.1 Electrical Characteristics at $T_A = 25\text{ }^\circ\text{C}$, unless otherwise specified

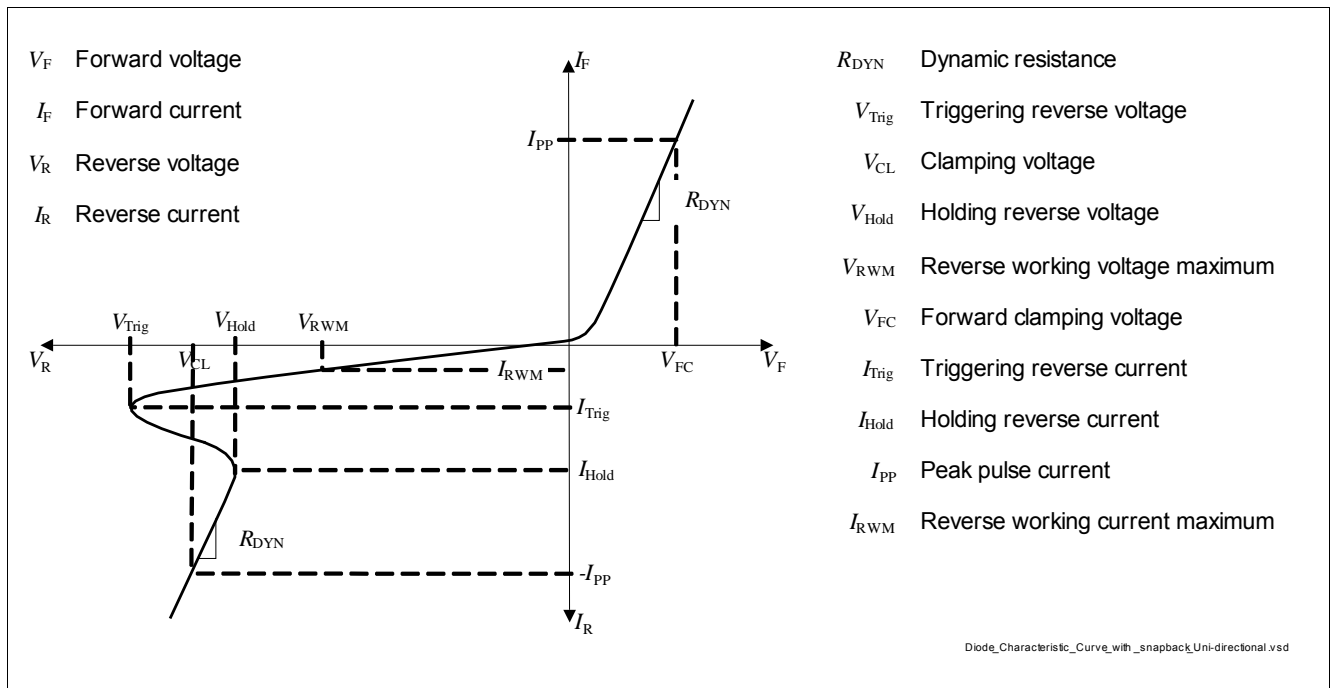

Figure 2 Definitions of Electrical Characteristics

Characteristics
Table 3 DC Characteristics at $T_A = 25\text{ }^\circ\text{C}$, unless otherwise specified

Parameter	Symbol	Values			Unit	Note / Test Condition
		Min.	Typ.	Max.		
Reverse working voltage	V_{RWM}	–	–	3.3	V	Pin 1 to Pin 2
Breakdown voltage	V_{BR}	–	6.5	–	V	from Pin 1 to Pin 2 voltage forced
Reverse current	I_R	–	1	50	nA	$V_R = 3.3\text{ V}$, from Pin 1 to Pin 2

Table 4 RF Characteristics at $T_A = 25\text{ }^\circ\text{C}$, unless otherwise specified

Parameter	Symbol	Values			Unit	Note / Test Condition
		Min.	Typ.	Max.		
Line capacitance ¹⁾	C_L	–	0.4	0.65	pF	$V_R = 0\text{ V}$, $f = 1\text{ MHz}$
		–	0.4	0.65	pF	$V_R = 0\text{ V}$, $f = 1\text{ GHz}$
Series inductance	L_S	–	0.2	–	nH	

1) Total capacitance line to ground

Table 5 ESD Characteristics at $T_A = 25\text{ }^\circ\text{C}$, unless otherwise specified

Parameter	Symbol	Values			Unit	Note / Test Condition
		Min.	Typ.	Max.		
Trigger voltage ¹⁾ [2]	V_{TRIG}	–	7.2	–	V	TLP, from Pin 1 to Pin 2
Reverse clamping voltage ¹⁾ [2]	V_{CL}	–	8	–	V	TLP, $I_{PP} = 16\text{ A}$, from Pin 1 to Pin 2
		–	11	–	V	TLP, $I_{PP} = 30\text{ A}$, from Pin 1 to Pin 2
Forward clamping voltage ¹⁾ [2]	V_{FC}	–	6	–	V	TLP, $I_{PP} = 16\text{ A}$, from Pin 2 to Pin 1
		–	9	–	V	TLP, $I_{PP} = 30\text{ A}$, from Pin 2 to Pin 1
Dynamic resistance ¹⁾ [2]	R_{DYN}	–	0.19	–	Ω	TLP, Pin 1 to Pin 2
		–	0.23	–	Ω	TLP, Pin 2 to Pin 1

1) Please refer to Application Note AN210. ANSI/ESD STM5.5.1 - Electrostatic Discharge Sensitivity Testing using Transmission Line Pulse (TLP), $t_p = 100\text{ ns}$, $t_r = 0.6\text{ ns}$, I_{TLP} and V_{TLP} averaging window: $t_1 = 30\text{ ns}$ to $t_2 = 60\text{ ns}$, extraction of dynamic TLP characteristic between $I_{PP1} = 10\text{ A}$ and $I_{PP2} = 40\text{ A}$.

2.2 Typical Characteristics at $T_A=25^\circ\text{C}$, unless otherwise specified

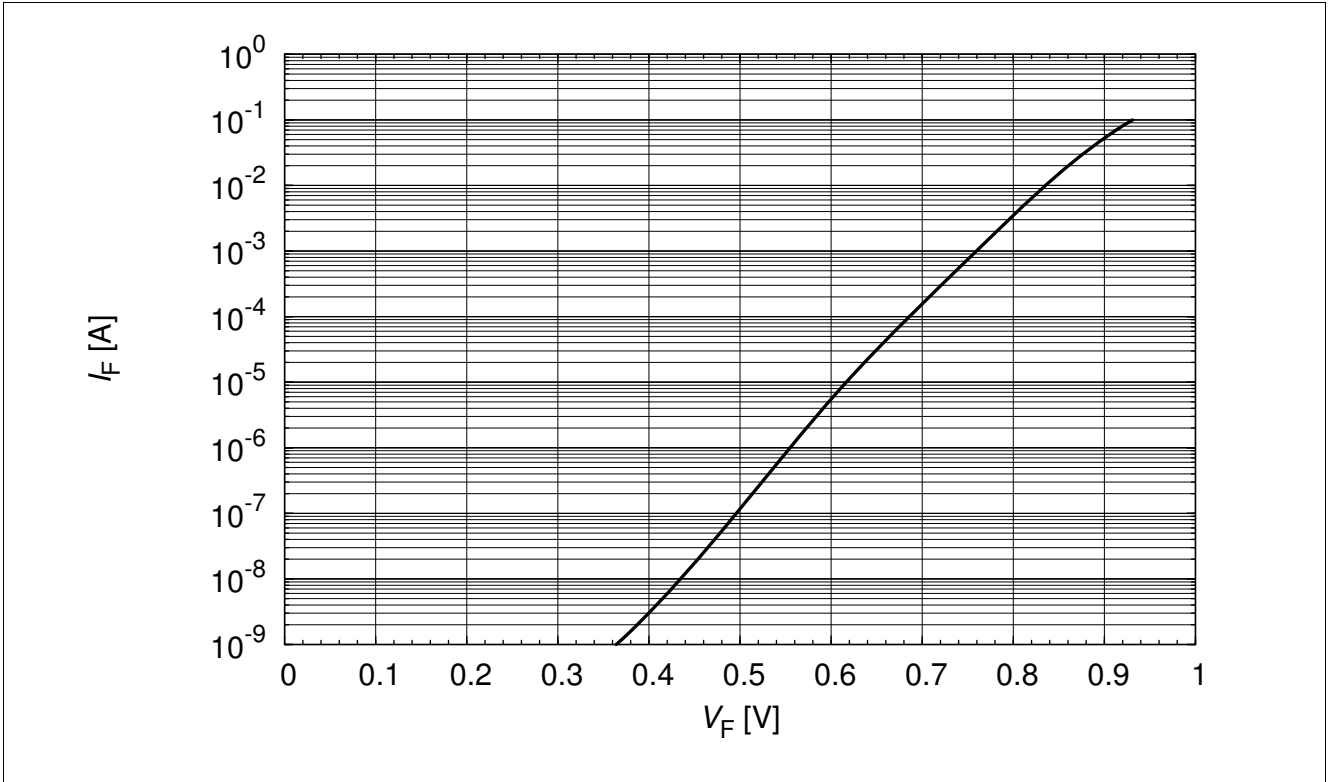

Figure 3 Forward current, $I_F = (V_F)$

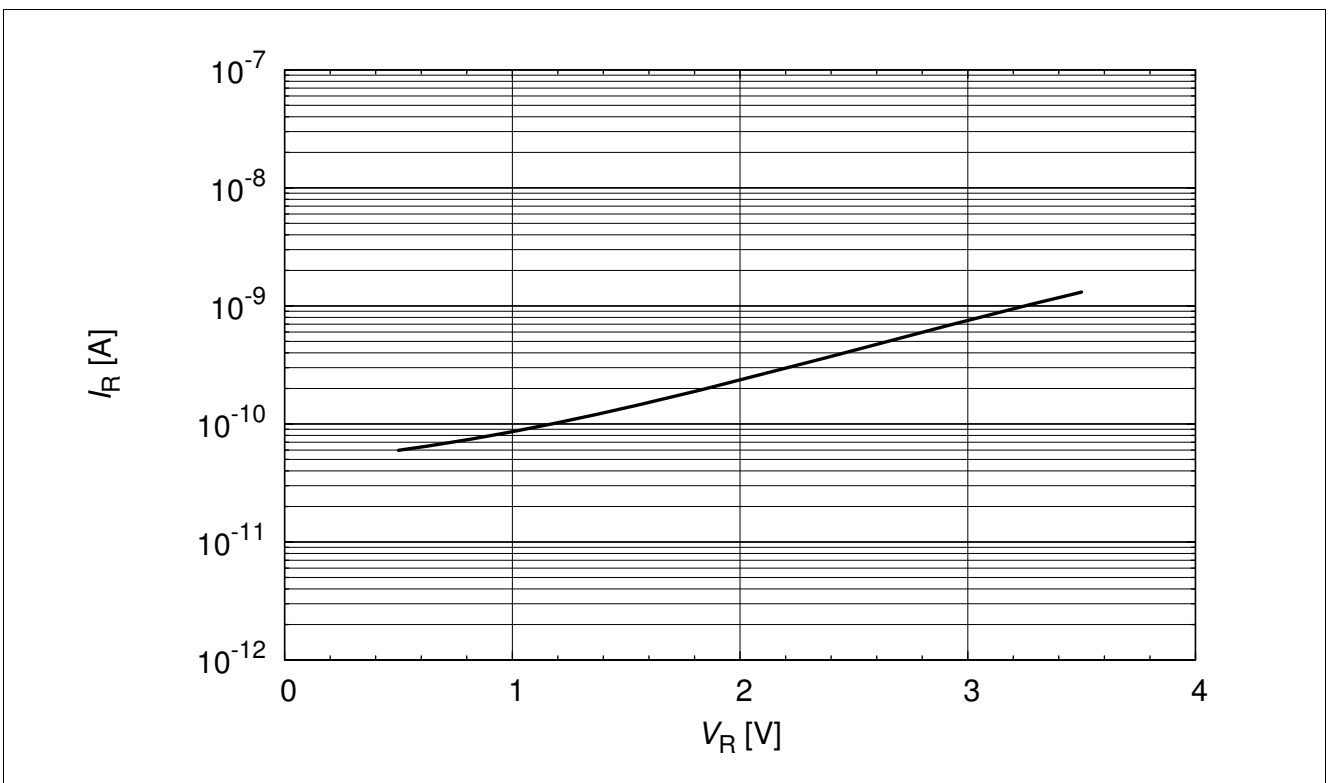

Figure 4 Reverse current, $I_R = (V_R)$

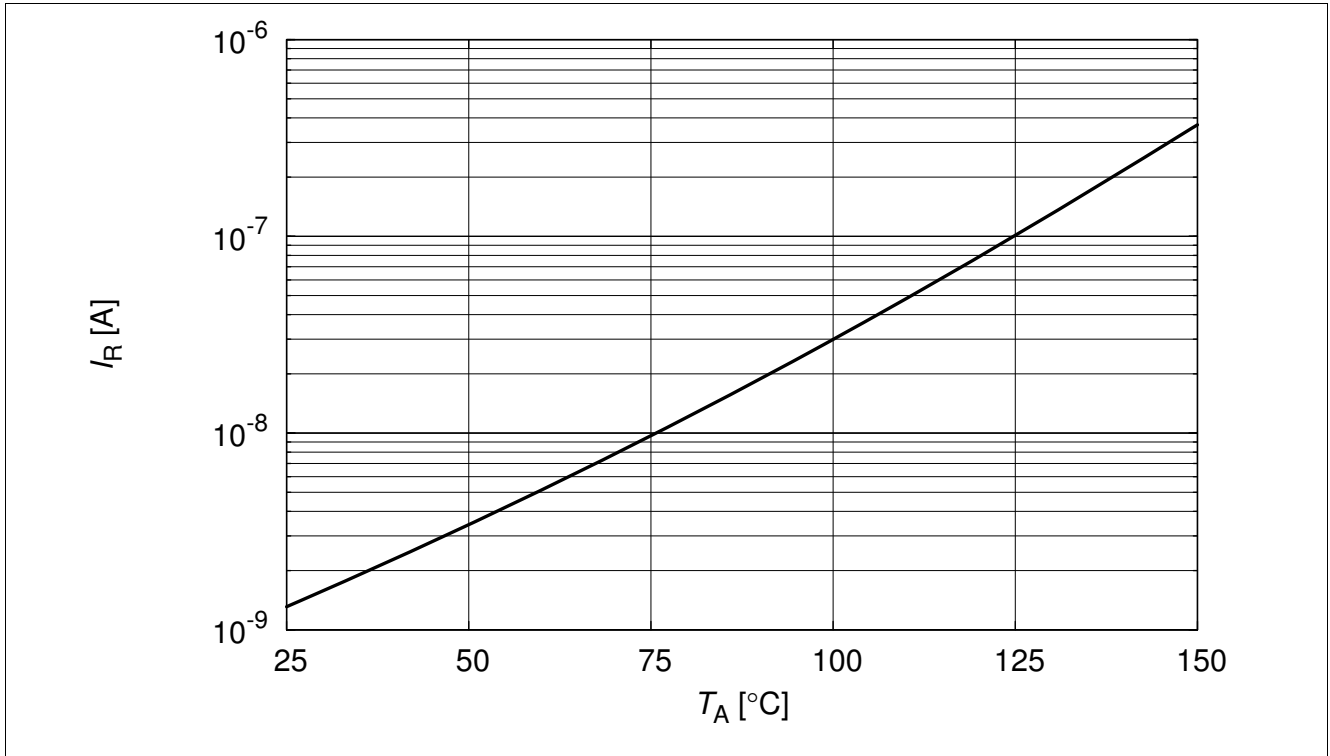

Figure 5 Reverse current $I_R = f(T_A)$, $V_R = 3.3$ V

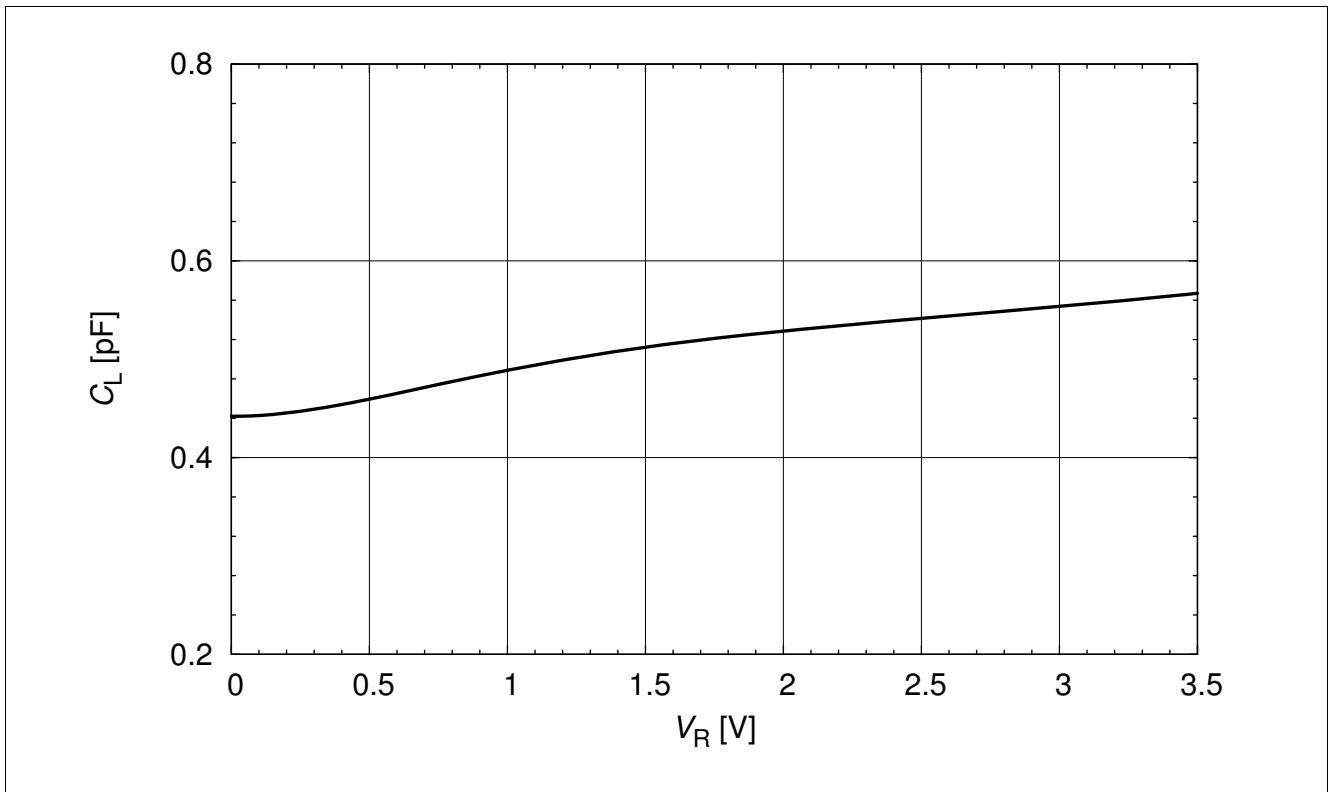

Figure 6 Line capacitance $C_L = f(V_R)$, $f = 1$ MHz, from pin 1 to pin 2

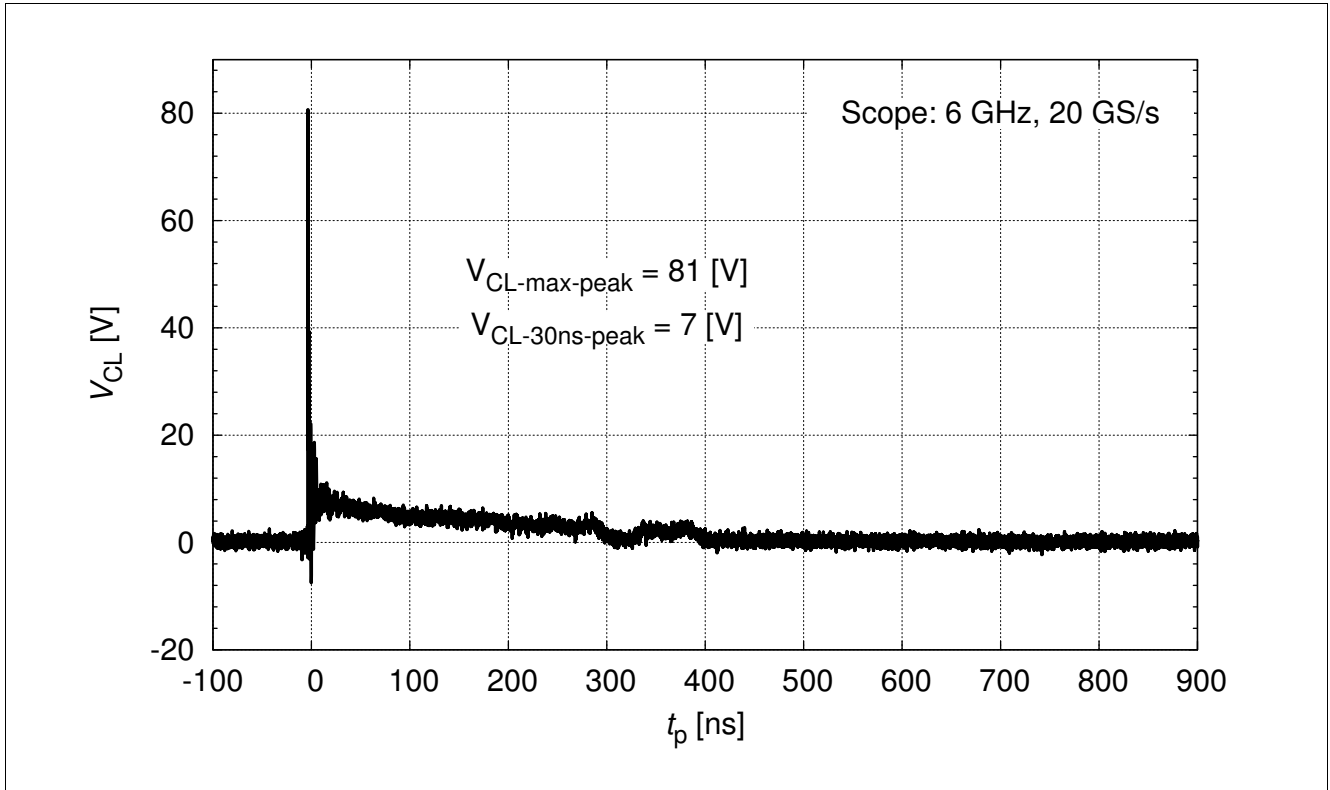

Figure 7 IEC61000-4-2 $V_{CL} = f(t)$, 8 kV positive pulse from pin 1 to pin 2

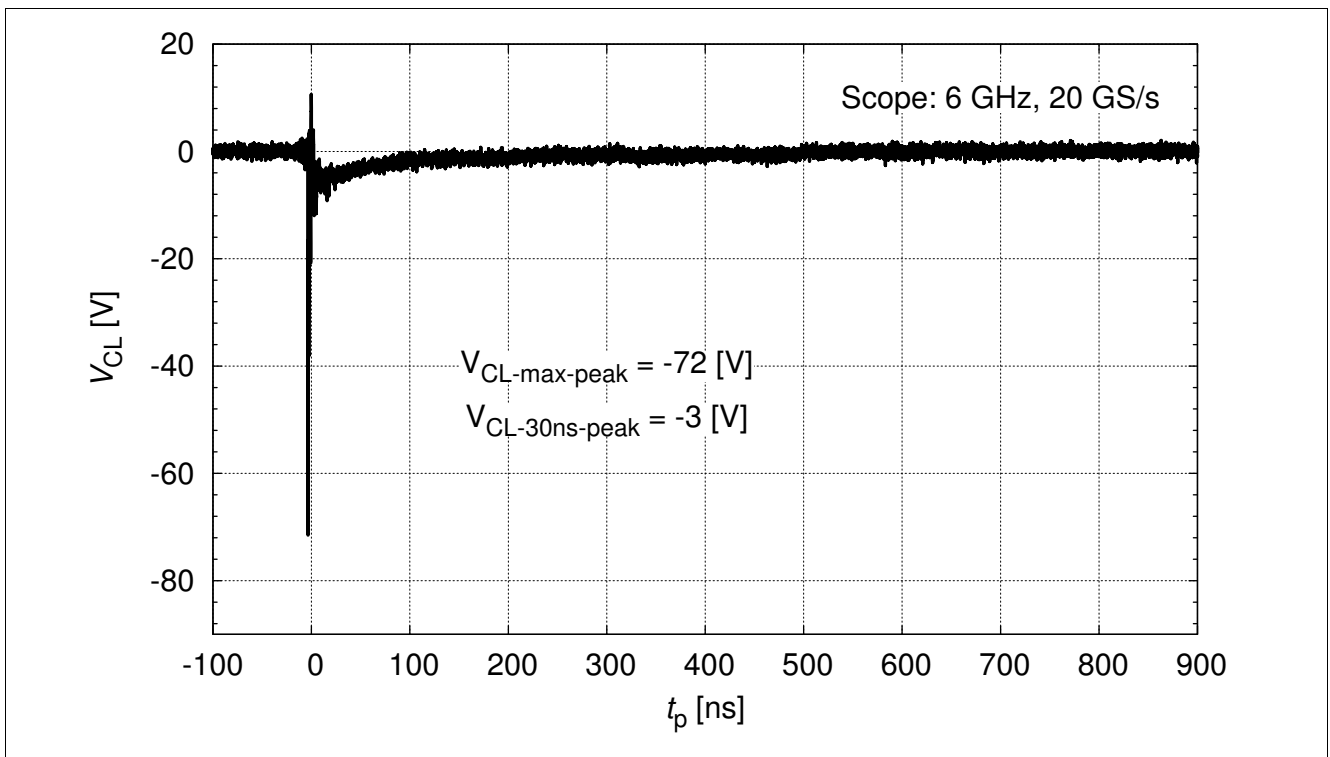

Figure 8 IEC61000-4-2 $V_{CL} = f(t)$, 8 kV negative pulse from pin 1 to pin 2

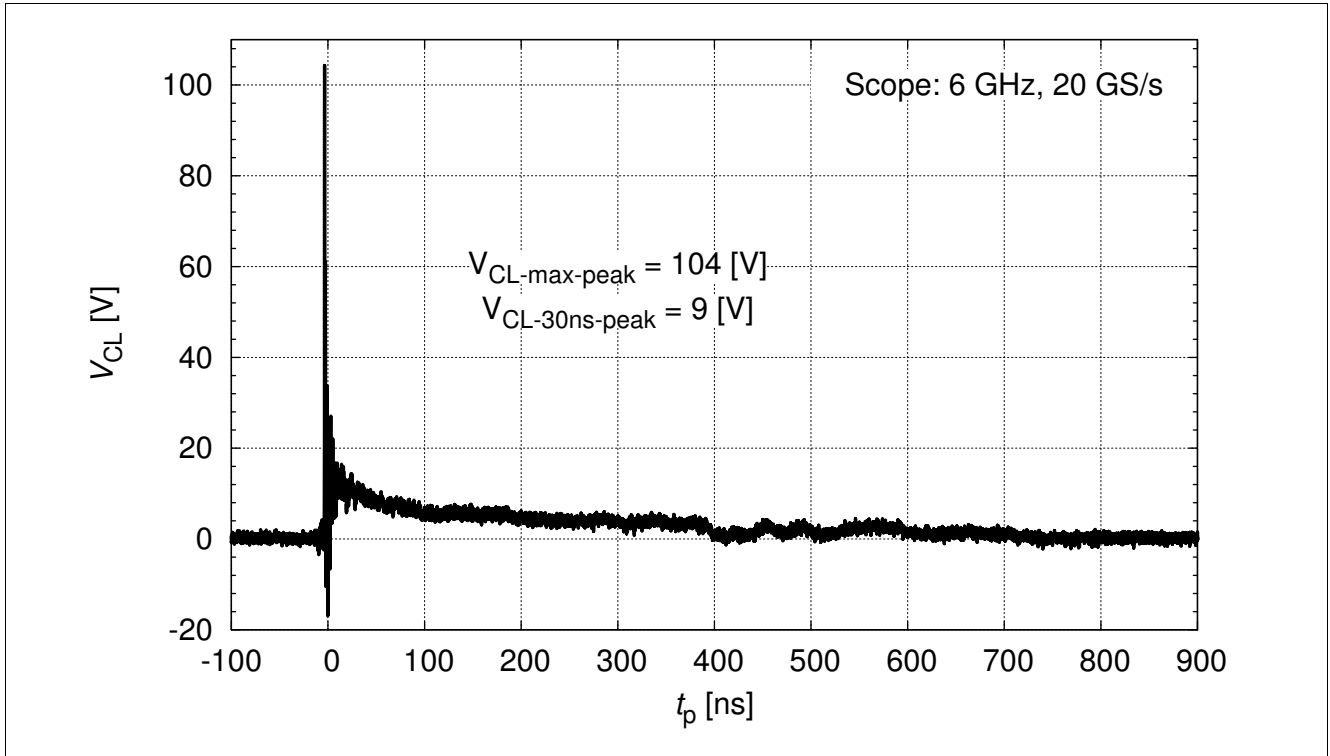

Figure 9 IEC61000-4-2 $V_{CL} = f(t)$, 15 kV positive pulse from pin 1 to pin 2

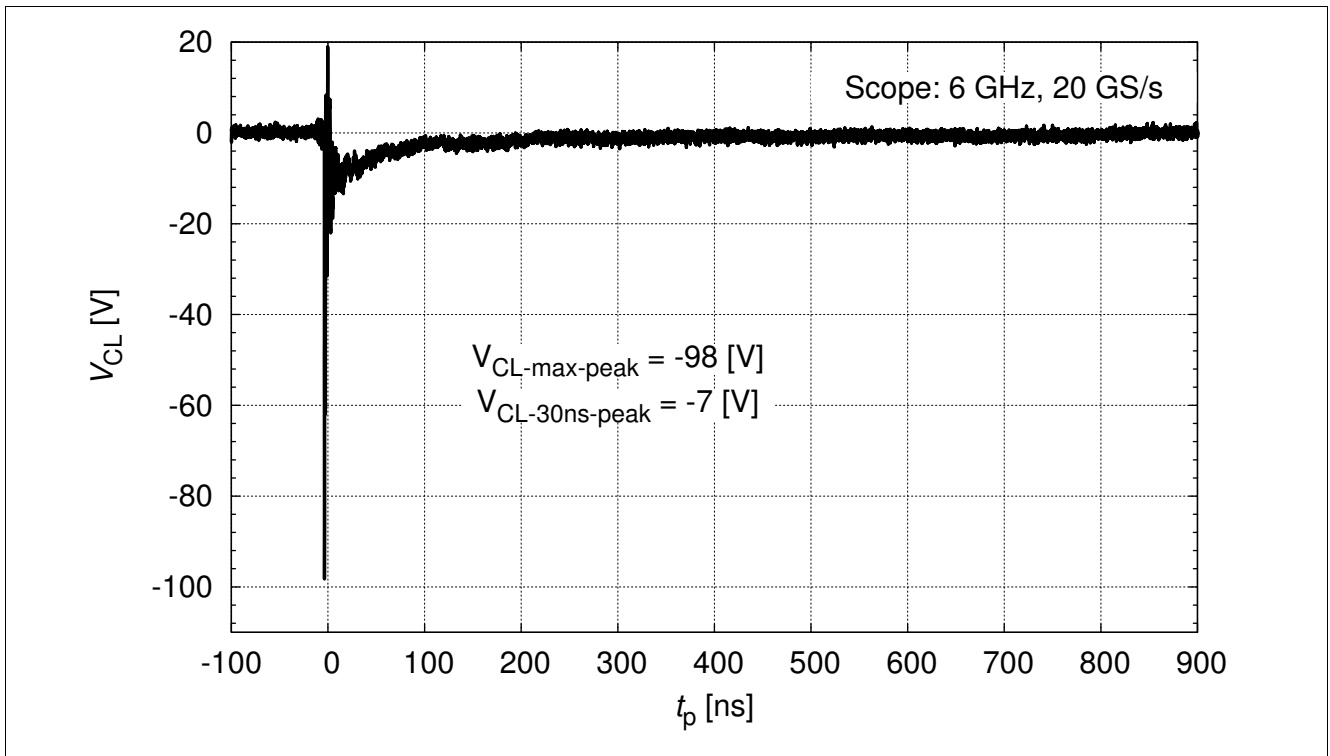

Figure 10 IEC61000-4-2 $V_{CL} = f(t)$, 15 kV negative pulse from pin 1 to pin 2

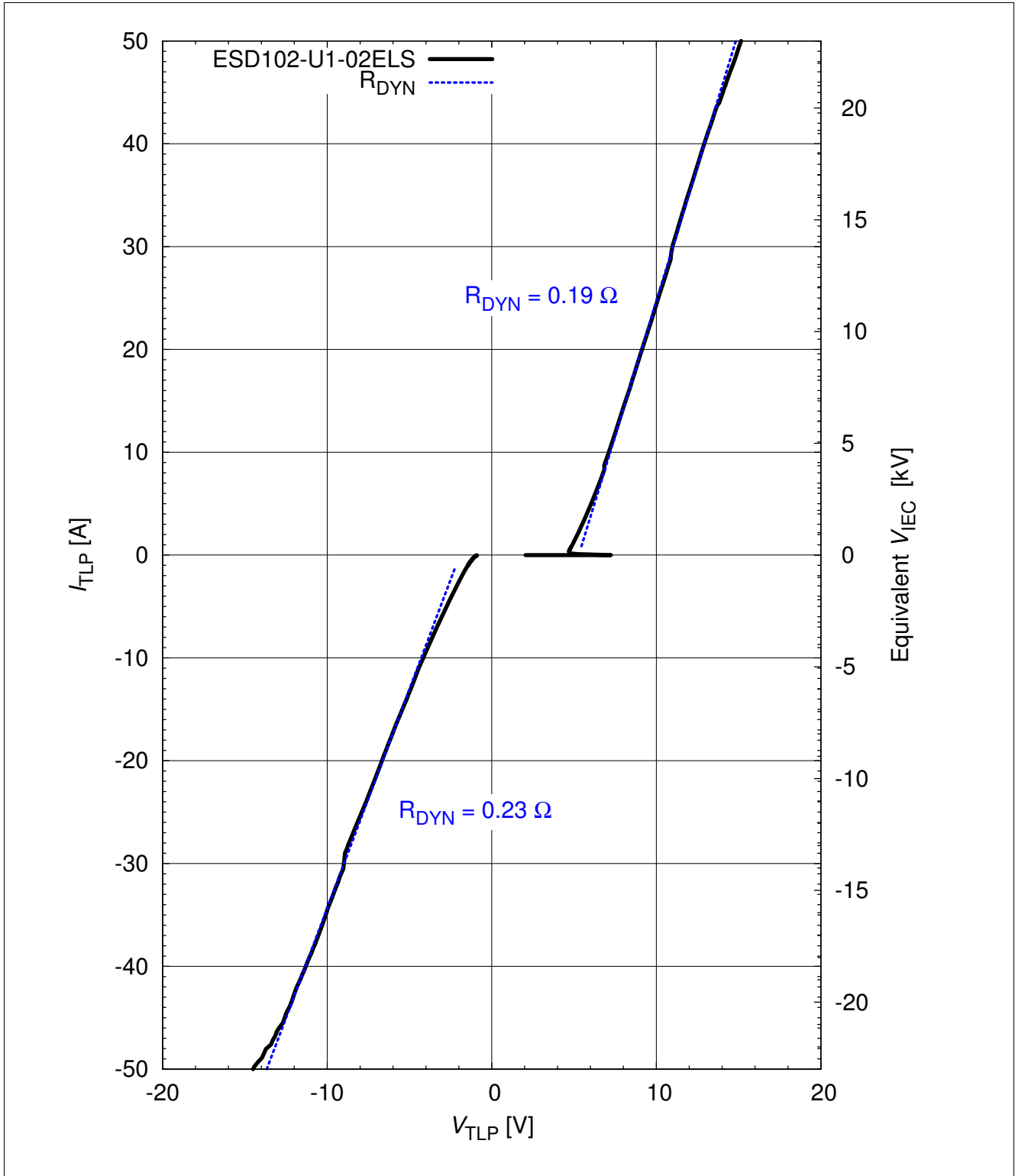

Figure 11 Clamping voltage $V_{TLP} = f(I_{TLP})$, [2]

Note: TLP parameter: $Z_0 = 50 \Omega$, $t_p = 100 \text{ ns}$, $t_r = 600 \text{ ps}$, averaging window: $t_1 = 30 \text{ ns}$ to $t_2 = 60 \text{ ns}$, extraction of dynamic resistance using least squares fit of TLP characteristic between $I_{PP1} = 10 \text{ A}$ and $I_{PP2} = 40 \text{ A}$. The equivalent stress level V_{IEC} according IEC 61000-4-2 ($R = 330 \Omega$, $C = 150 \text{ pF}$) is calculated at the broad peak of the IEC waveform at $t = 30 \text{ ns}$ with 2 A/kV

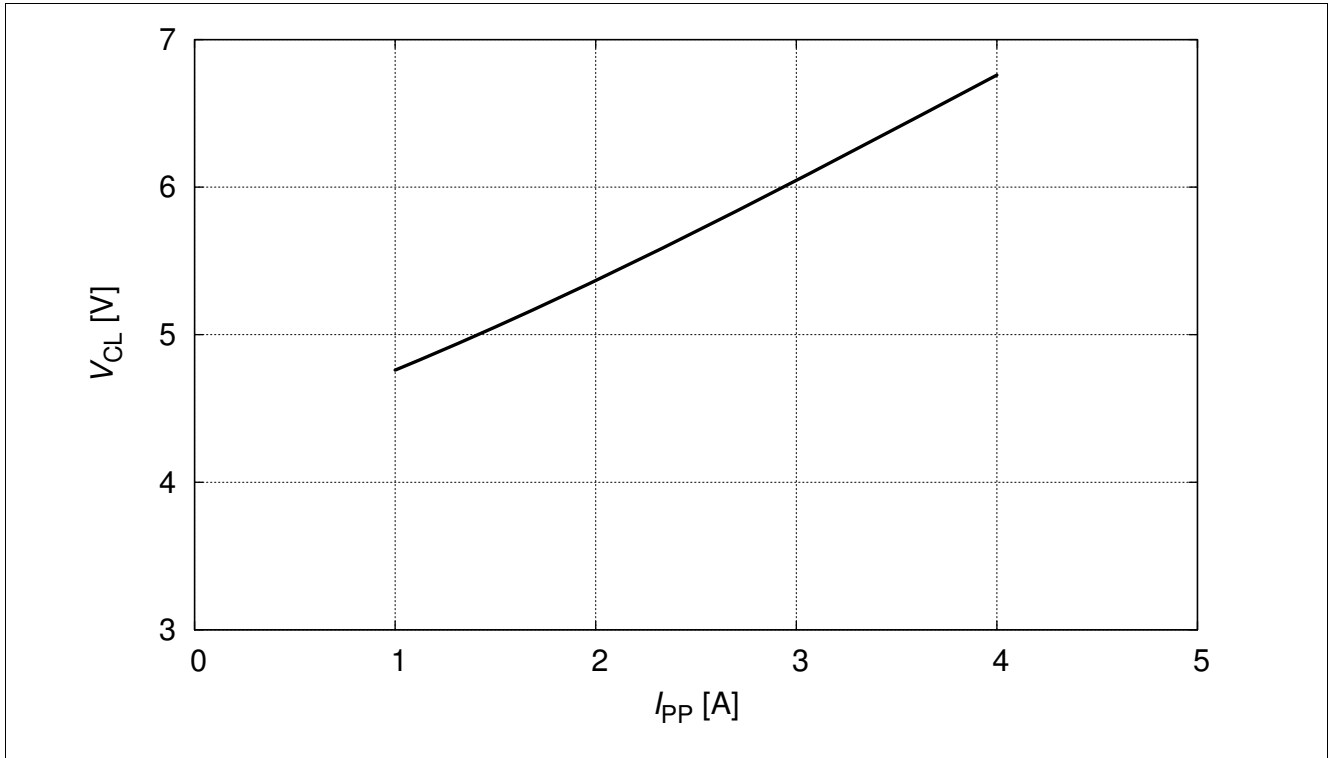

Figure 12 Reverse clamping voltage $I_{PP} = f(V_{CL})$, from pin 1 to pin 2 according to IEC61000-4-5 (8/20 μ s)

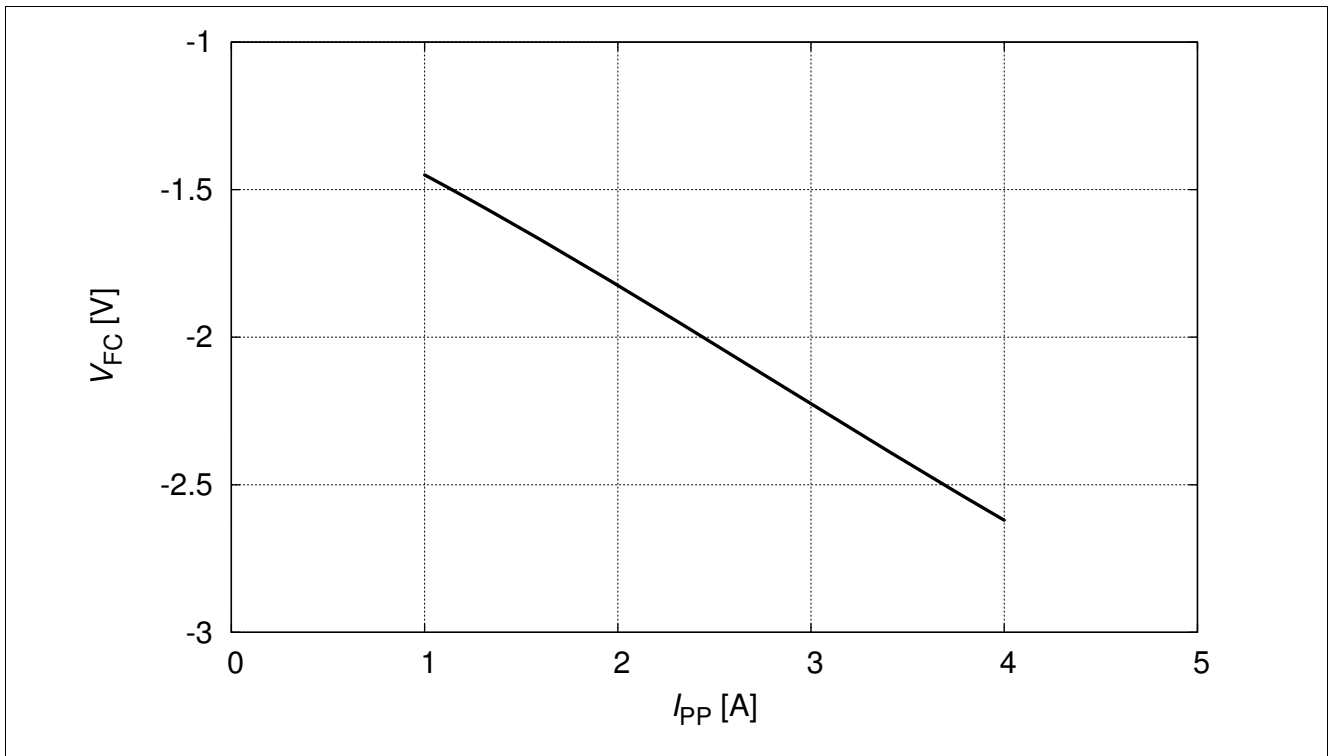

Figure 13 Forward clamping voltage $I_{PP} = f(V_{FC})$, from pin 1 to pin 2 according to IEC61000-4-5 (8/20 μ s)

3 Application Information

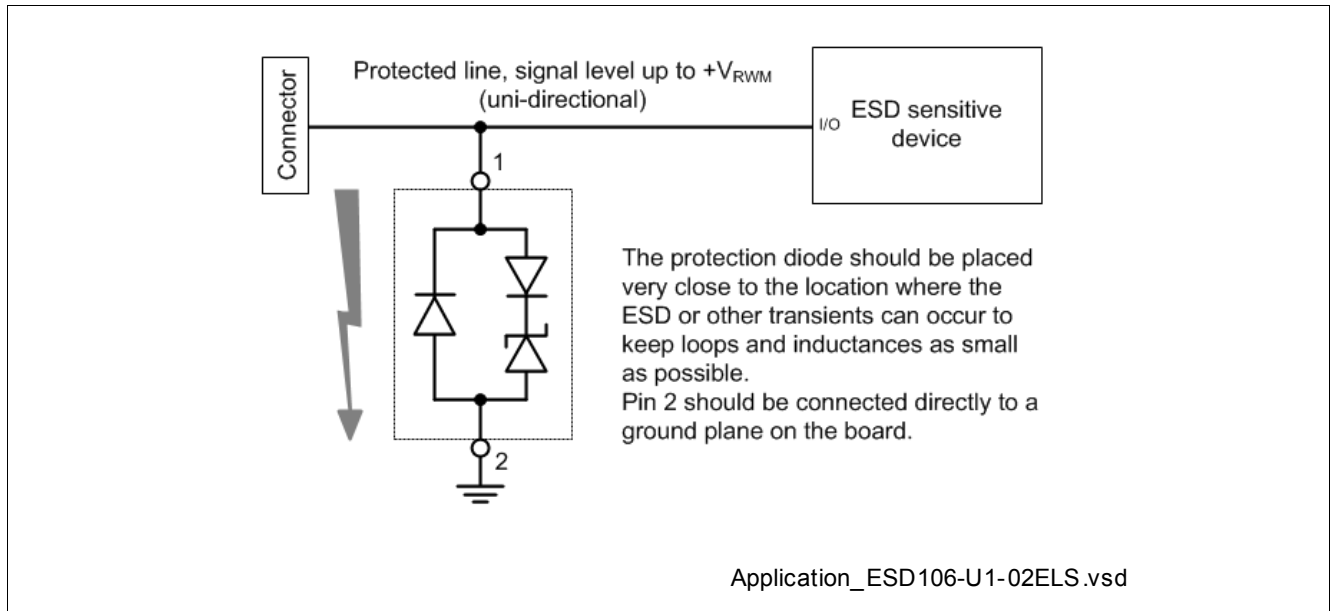

Figure 14 Single line, uni-directional ESD / Transient protection[2]

4 Package Information

4.1 TSSLP-2-3 (mm) [3]

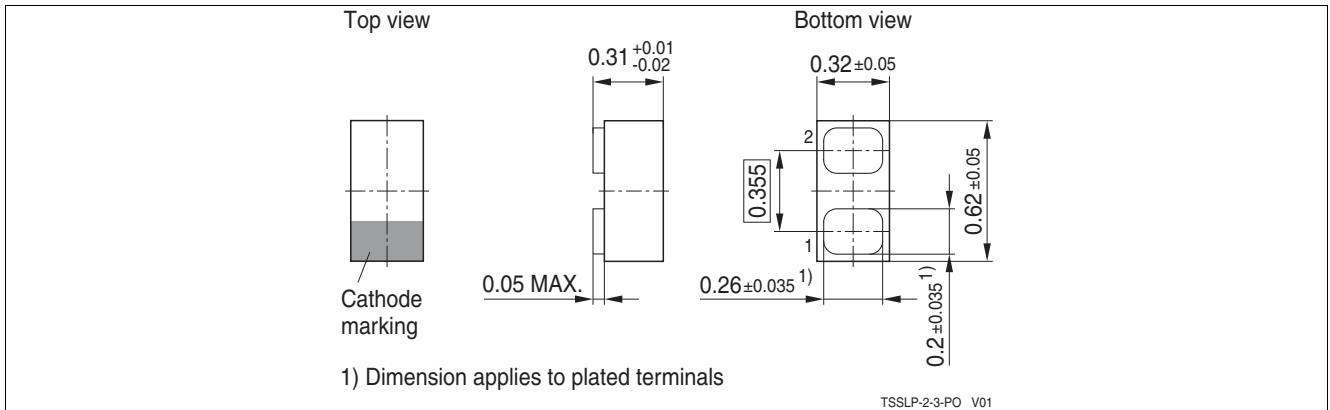

Figure 15 Package outline for TSSLP-2-3 (dimension in mm)

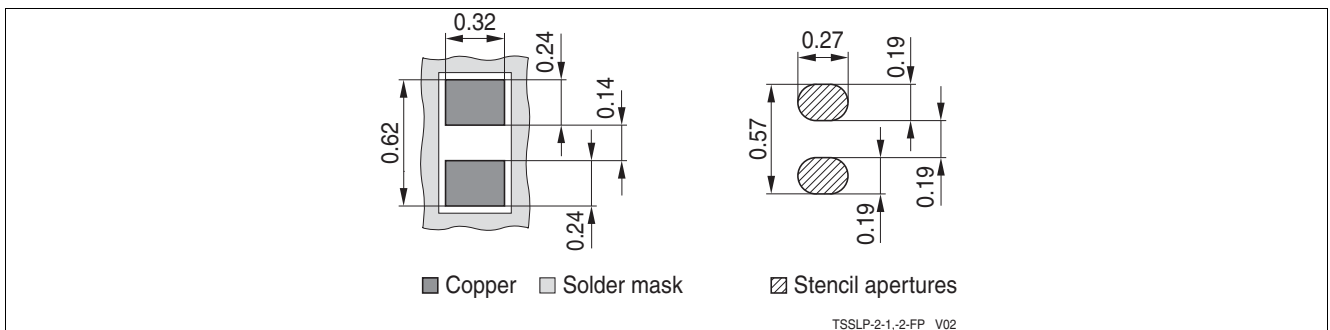

Figure 16 Package footprint for TSSLP-2-3 (dimension in mm)

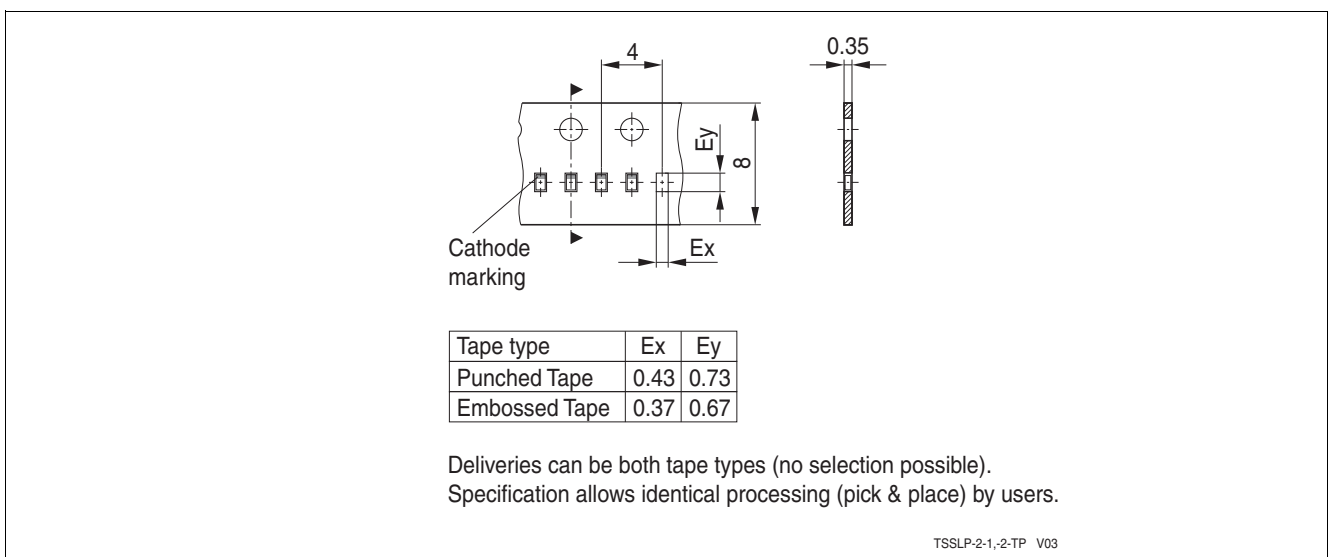

Figure 17 Tape and Reel Information for TSSLP-2-3 (dimension in mm)

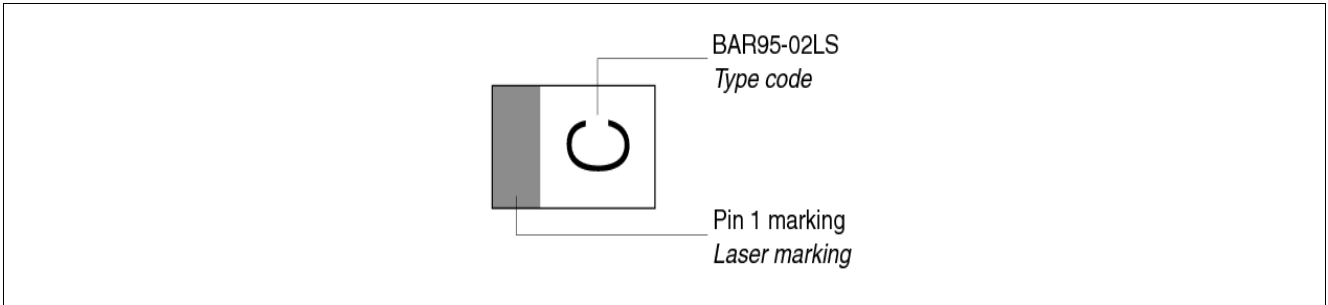

Figure 18 Marking for TSSLP-2-3 (example)

References

- [1] On-chip ESD protection for integrated circuits, Albert Z. H. Wang, ISBN:0-7923-7647-1
- [2] Infineon AG - **Application Note AN210**: Effective ESD Protection Design at System Level Using VF-TLP Characterization Methodology
- [3] Infineon AG - Recommendations for PCB Assembly of Infineon TSLP and TSSLP Package

www.infineon.com

Published by Infineon Technologies AG