

MGA-31816

0.1 W High Linearity Driver Amplifier



Data Sheet

Description

Avago Technologies MGA-31816 is a high linearity driver MMIC Amplifier housed in a standard QFN 3X3 16 lead plastic package. It features high gain, low operating current, good noise figure with good input and output return loss. Power consumption can be further reduced by reducing the quiescent bias current using two external gain bias resistors. The device can be easily matched at different frequencies to obtain optimal linearity performance at those frequencies.

MGA-31816 is especially ideal for 50 Ω wireless infrastructure application operating from 1.5 GHz to 4 GHz frequency range applications. With the high linearity, excellent gain flatness and low noise figure the MGA-31816 may be utilized as a driver amplifier in the transmit chain and as a second stage LNA in the receiver chain.

This device uses Avago Technologies proprietary 0.25 μm GaAs Enhancement mode PHEMT process.

Pin connections and Package Marking

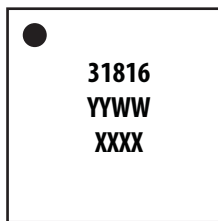

TOP VIEW

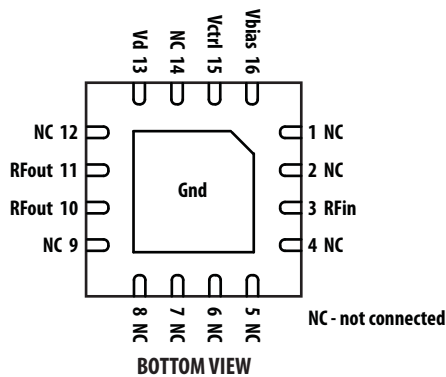

BOTTOM VIEW

Notes:
 Package marking provides orientation and identification
 "31816" = Device Part Number
 "YYWW" = Work Week and Year of manufacturing
 "XXXX" = Last 4 digit of Lot Number

Features

- Very high linearity at low DC bias power ^[1]
- High Gain with good gain flatness
- Good Noise Figure
- ROHS compliant
- Halogen free
- Advanced enhancement-mode PHEMT Technology
- QFN 3X3 16-Lead standard package
- Lead-free MSL1

Specifications

At 1900 MHz, $V_{dd} = 5\text{ V}$, $I_{dd} = 59\text{ mA (typ)}$ @ 25° C

- OIP3 = 40.5 dBm
- Noise Figure = 1.6 dB
- Gain = 19.5 dB
- P1dB = 20.5 dBm
- IRL = 16.5 dB, ORL = 10.6 dB

Note:

1. The MGA-31816 has a superior LFOM of 15.8 dB. Linearity Figure of Merit (LFOM) is essentially OIP3 divided by DC bias power.



Attention: Observe precautions for handling electrostatic sensitive devices.
 ESD Machine Model = 60 V
 ESD Human Body Model = 300 V
 Refer to Avago Application Note A004R:
 Electrostatic Discharge, Damage and Control.

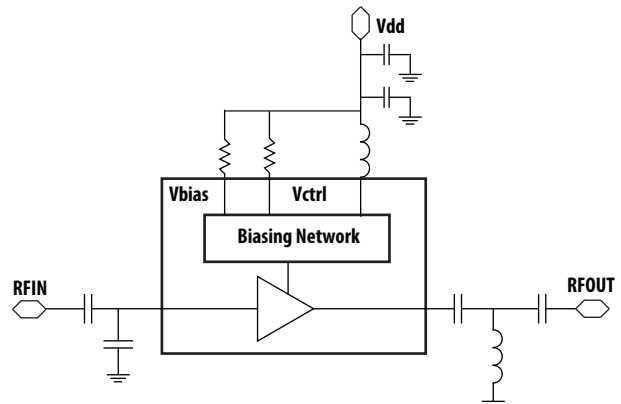

Figure 1. Simplified Application Circuit

Table 1. MGA-31816 Absolute Maximum Rating^[1] ($T_A = 25^\circ\text{C}$)

Symbol	Parameter	Units	Absolute Maximum
$V_{dd, \max}$	Drain Voltage	V	5.5
$V_{bias, \max}$	Bias Voltage	V	5.5
$V_{ctrl, \max}$	Control Voltage	V	5.5
P_d	Power Dissipation ^[2]	mW	605
P_{in}	CW RF Input Power	dBm	24
T_j	Junction Temperature	$^\circ\text{C}$	150
T_{stg}	Storage Temperature	$^\circ\text{C}$	-65 to 150
T_{amb}	Ambient Temperature	$^\circ\text{C}$	-40 to 85

Thermal Resistance

Thermal Resistance^[3]
 $(V_{dd} = 5.0\text{V}, T_C = 85^\circ\text{C}) \theta_{jc} = 65.8^\circ\text{C/W}$

Notes:

1. Operation of this device in excess of any of these limits may cause permanent damage
2. Source lead temperature is 25°C . Derate $15.2\text{ mW}/^\circ\text{C}$ for $T_L > 126.0^\circ\text{C}$.
3. Thermal resistance measured using 150°C Infra-Red Microscopy Technique.

Table 2. MGA-31816 Electrical Specification^[1] $T_C = 25^\circ\text{C}, V_{dd} = 5.0\text{V}$, unless noted

Symbol	Parameter and Test Condition	Frequency	Units	Min.	Typ.	Max.
I_{ds}	Quiescent Current	1900 MHz	mA	37	59	83
		2600 MHz			61	
		3500 MHz			59	
NF	Noise Figure	1900 MHz	dB	-	1.6	2.4
		2600 MHz			1.6	
		3500 MHz			1.8	
Gain	Gain	1900 MHz	dB	18	19.5	21
		2600 MHz			18.8	
		3500 MHz			18.5	
OIP3 ^[2]	Output Third Order Intercept Point	1900 MHz	dBm	37	40.5	-
		2600 MHz			42.0	
		3500 MHz			41.3	
LFOM ^[2, 3]	Linearity Figure of Merit	1900 MHz	dB	-	15.8	-
		2600 MHz			17.3	
		3500 MHz			16.9	
P1dB	Output Power at 1dB Gain Compression	1900 MHz	dBm	19	20.5	-
		2600 MHz			19.8	
		3500 MHz			19.3	
PAE	Power Added Efficiency at P1dB	1900 MHz	%	-	38.2	-
		2600 MHz			31.6	
		3500 MHz			29.9	
IRL	Input Return Loss	1900 MHz	dB	-	16.5	-
		2600 MHz			22.9	
		3500 MHz			21.1	
ORL	Output Return Loss	1900 MHz	dB	-	10.6	-
		2600 MHz			10.0	
		3500 MHz			11.4	
ISOL	Isolation	1900 MHz	dB	-	25.7	-
		2600 MHz			26.5	
		3500 MHz			28.1	

Notes:

1. Measurements obtained from test circuits detailed in Figures 46 and 47 and Table 3.
2. OIP3 test condition: $F1 - F2 = 1\text{ MHz}$, with input power of -13 dBm per tone measured at worst case side band.
3. LFOM is defined as $\text{LFOM} = \text{OIP3 (in dBm)} - P_{DC}$ (in dBm). It is a measure of the linearity of an amplifier per unit of DC power consumed.
4. Demoboard tuned to best OIP3 with minimum over temperature drift.

MGA-31816 Consistency Distribution Chart [1, 2]

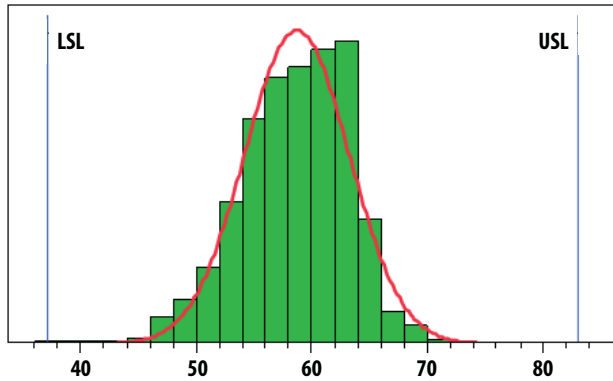

Figure 2. I_{dd} @ 1900 MHz; LSL = 37 mA, Nominal = 59 mA, USL = 83 mA

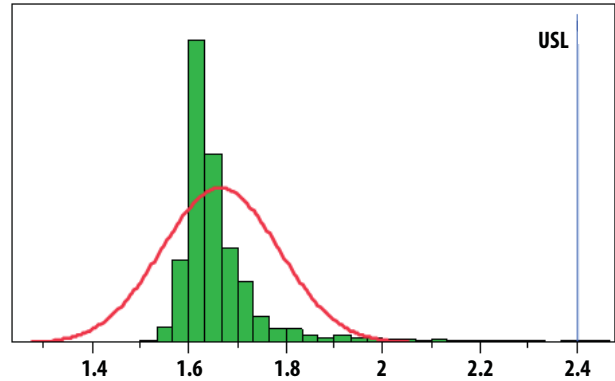

Figure 3. NF @ 1900 MHz; Nominal = 1.6 dB, USL = 2.4 dB

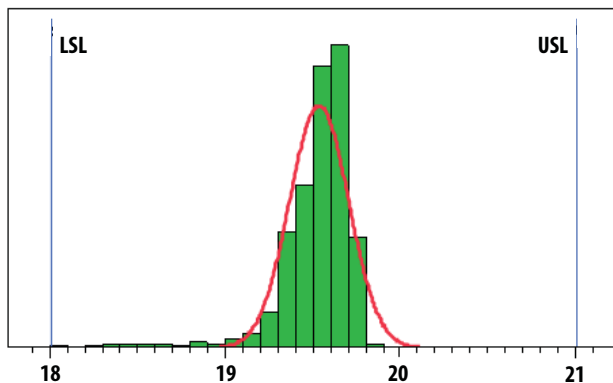

Figure 4. Gain @ 1900 MHz; LSL = 18 dB, Nominal = 19.5 dB, USL = 21 dB

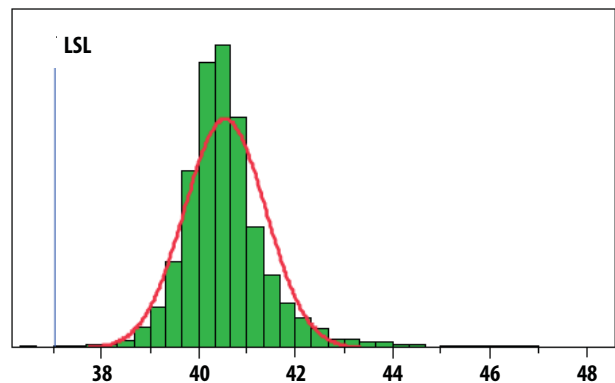

Figure 5. OIP3 @ 1900 MHz; Nominal = 40.5 dBm, LSL = 37 dBm

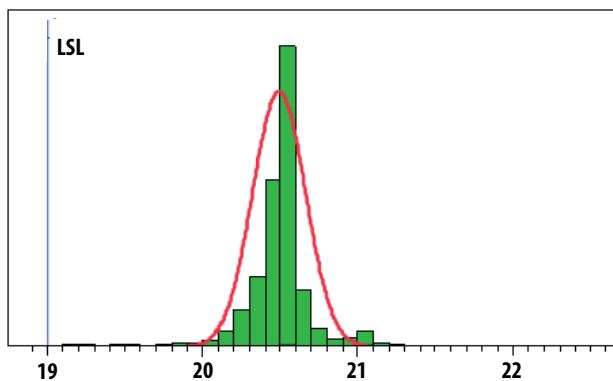

Figure 6. P1dB @ 1900 MHz; Nominal = 20.5 dBm, LSL = 19 dBm

Notes:

1. Data sample size is 4000 samples taken from 4 different wafers and 2 different lots. Future wafers allocated to this product may have nominal values anywhere between the upper and lower limits.
2. Measurements are made on production test board which represents a trade-off between optimal Gain, NF, OIP3 and OP1dB. Circuit losses have been de-embedded from actual measurements.

MGA-31816 Typical Performance Data for 1.9 GHz

$T_C = 25^\circ\text{C}$, $V_{DD} = 5.0\text{V}$, $I_{DD} = 59\text{mA}$ (Based on BOM in Table 3, tuned for optimal linearity with over temperature)

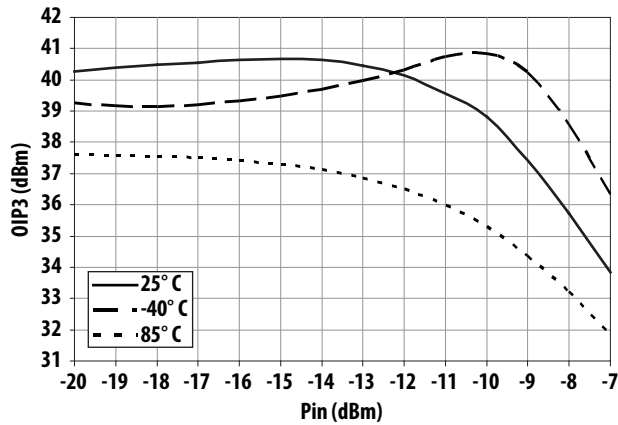

Figure 7. OIP3 vs Pin and Temperature

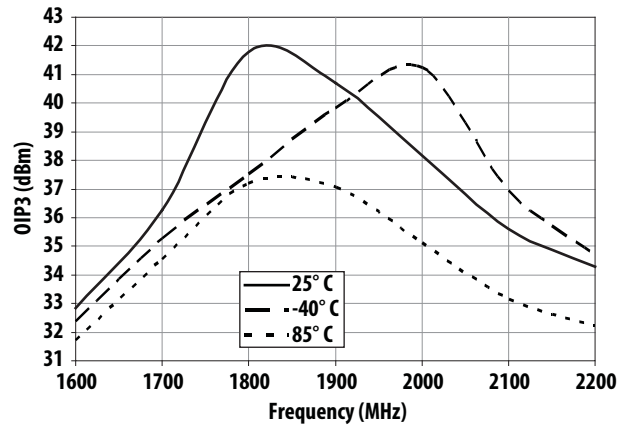

Figure 8. OIP3 vs Frequency and Temperature

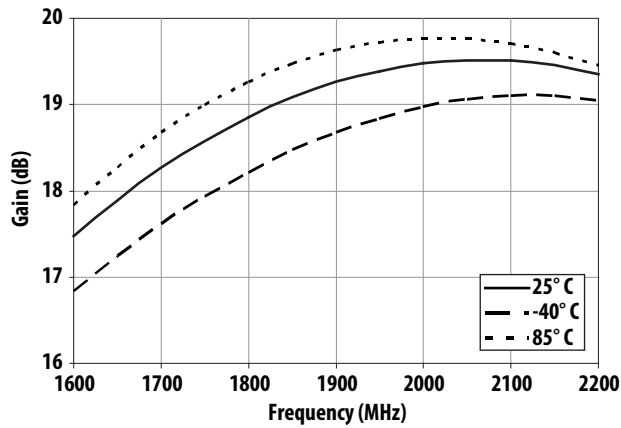

Figure 9. Gain vs Frequency and Temperature

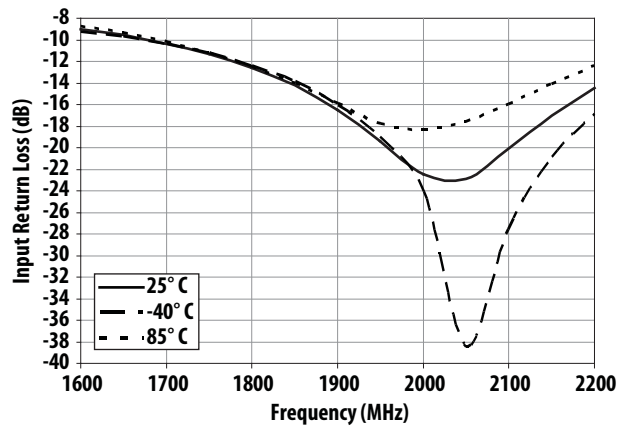

Figure 10. IRL vs Frequency and Temperature

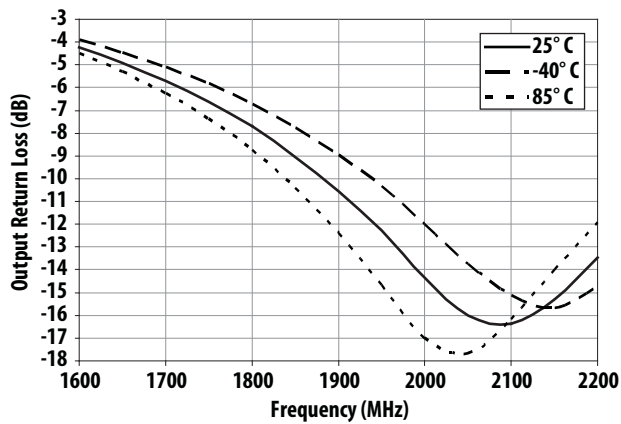

Figure 11. ORL vs Frequency and Temperature

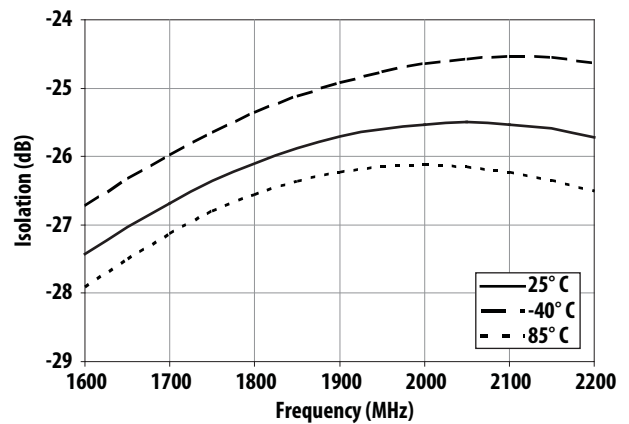

Figure 12. Isolation vs Frequency and Temperature

MGA-31816 Application Circuit Data for 1.9 GHz

$T_C = 25^\circ\text{C}$, $V_{dd} = 5.0\text{V}$, $I_{dd} = 59\text{mA}$ (Based on BOM in Table 3, tuned for optimal linearity with over temperature)

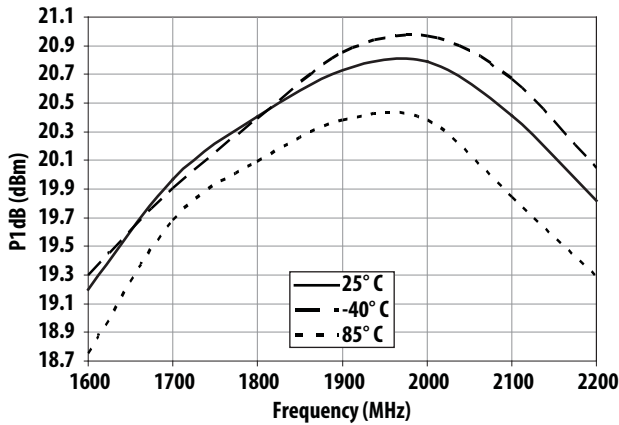

Figure 13. P1dB vs Frequency and Temperature

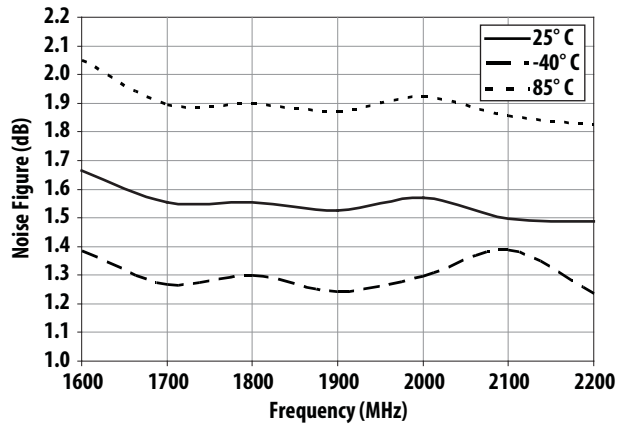

Figure 14. Noise Figure vs Frequency and Temperature

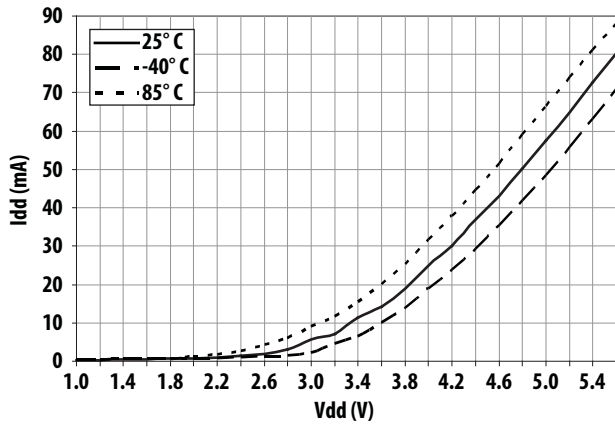

Figure 15. Current vs Voltage and Temperature

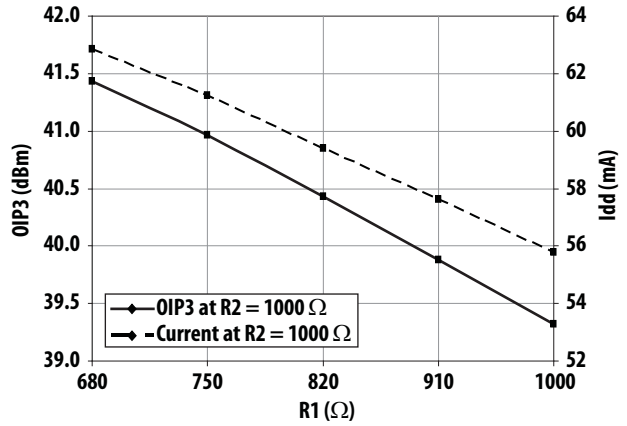

Figure 16. OIP3 and Quiescent Current with different R1^[1]

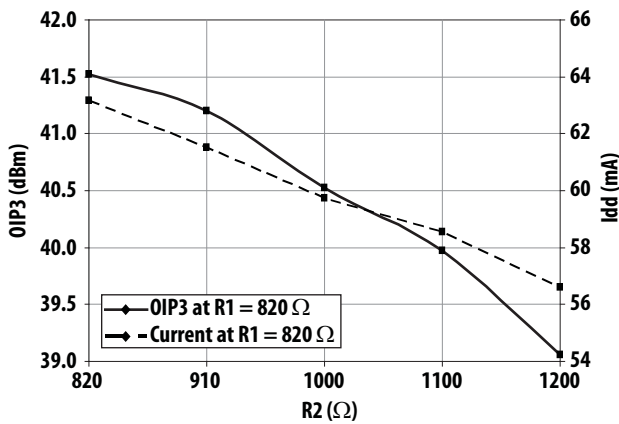

Figure 17. OIP3 and Quiescent Current with different R2^[1]

Note:

1. V_{bias} and V_{ctrl} can be externally controlled by change external biasing resistors $R1 = R_{bias}$ and $R2 = R_{ctrl}$ (as shown in Fig. 46).

MGA-31816 Application Circuit Data for 1.9 GHz

$T_C = 25^\circ\text{C}$, $V_{dd} = 5.0\text{V}$, $I_{dd} = 59\text{mA}$ (Based on BOM in Table 3, tuned for optimal linearity with over temperature)

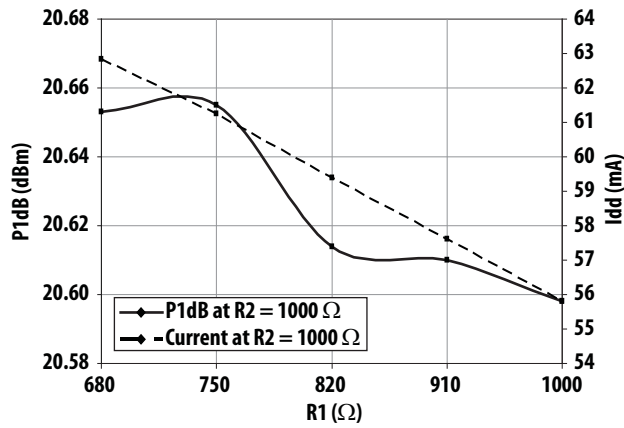

Figure 18. P1dB and Quiescent Current with different R1^[1]

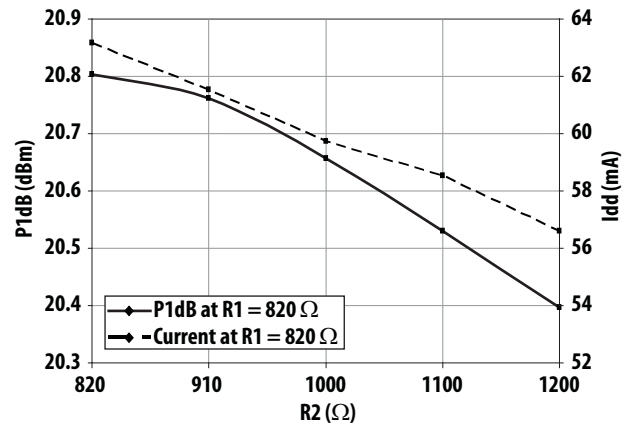

Figure 19. P1dB and Quiescent Current with different R2^[1]

Note:

- Vbias and Vctrl can be externally controlled by change external biasing resistors R1 = Rbias and R2 = Rctrl (as shown in Fig. 46).

MGA-31816 Application Circuit Data for 2.6 GHz

$T_C = 25^\circ\text{C}$, $V_{dd} = 5.0\text{V}$, $I_{dd} = 59\text{mA}$ (Based on BOM in Table 3, tuned for optimal linearity with over temperature)

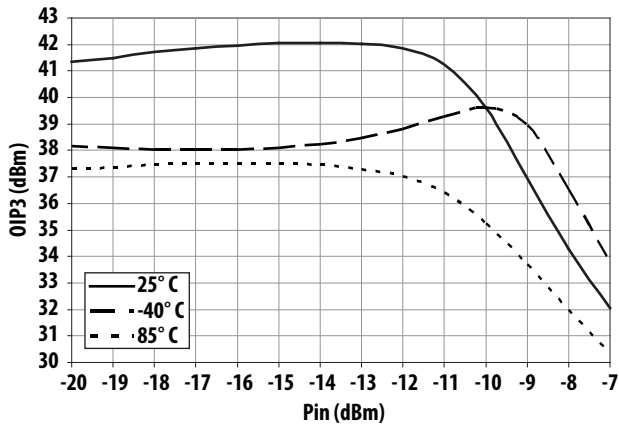

Figure 20. OIP3 vs Pin and Temperature

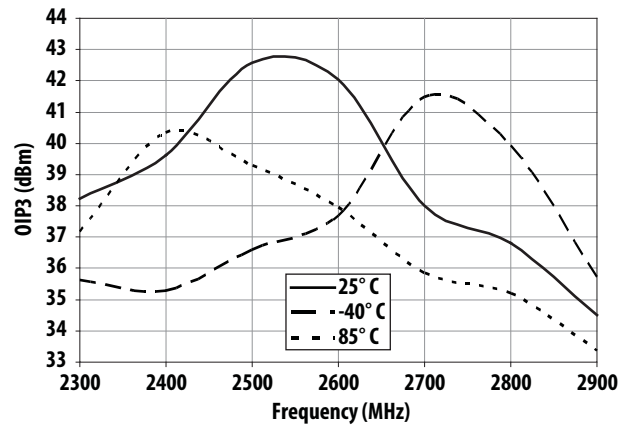

Figure 21. OIP3 vs Frequency and Temperature

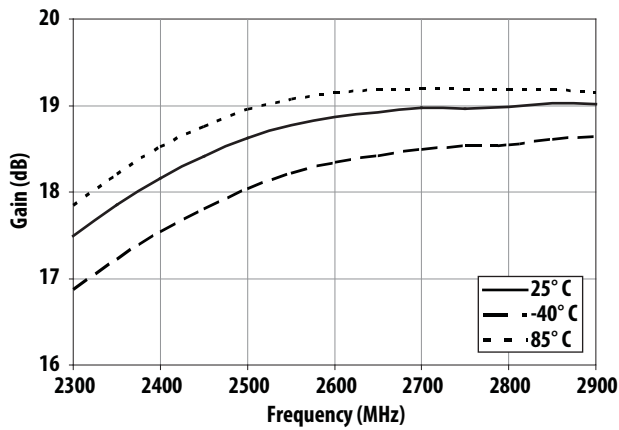

Figure 22. Gain vs Frequency and Temperature

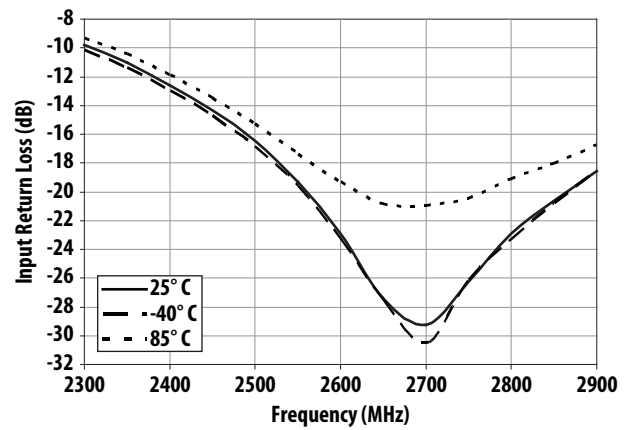

Figure 23. IRL vs Frequency and Temperature

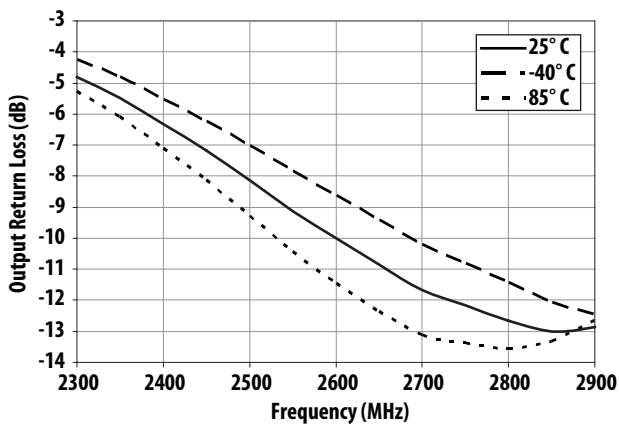

Figure 24. ORL vs Frequency and Temperature

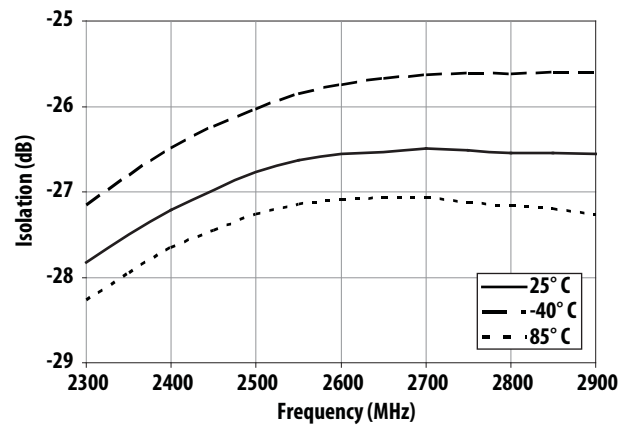

Figure 25. Isolation vs Frequency and Temperature

MGA-31816 Application Circuit Data for 2.6 GHz

$T_C = 25^\circ\text{C}$, $V_{dd} = 5.0\text{V}$, $I_{dd} = 59\text{mA}$ (Based on BOM in Table 3, tuned for optimal linearity with over temperature)

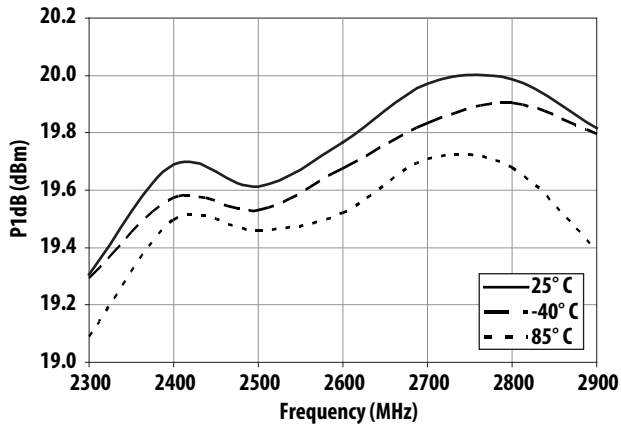

Figure 26. P1dB vs Frequency and Temperature

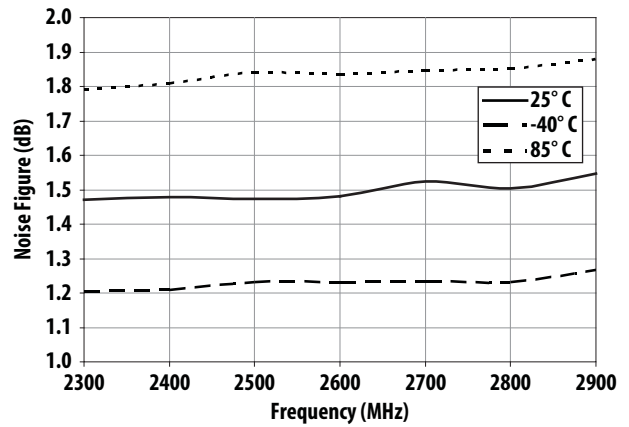

Figure 27. Noise Figure vs Frequency and Temperature

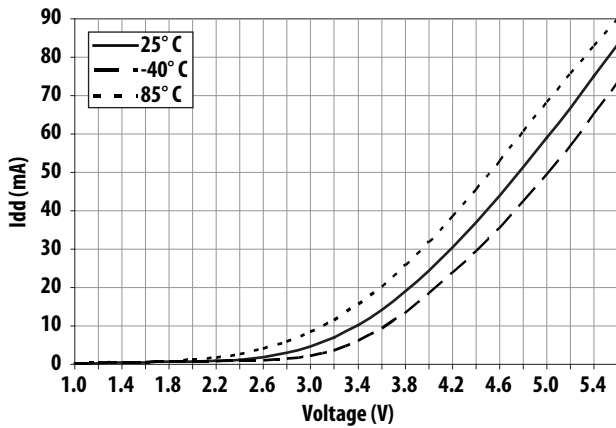

Figure 28. Current vs Voltage and Temperature

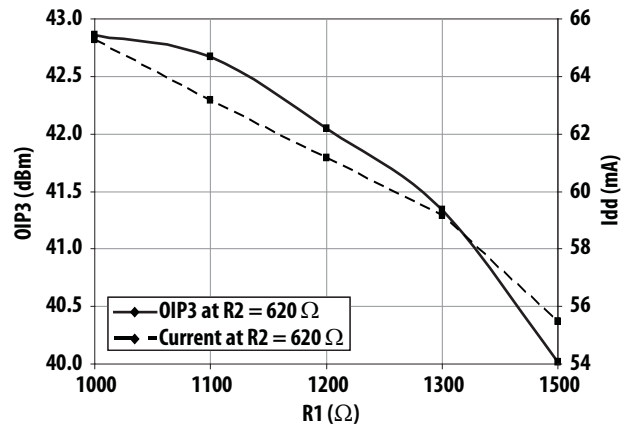

Figure 29. OIP3 and Quiescent Current with different R1^[1]

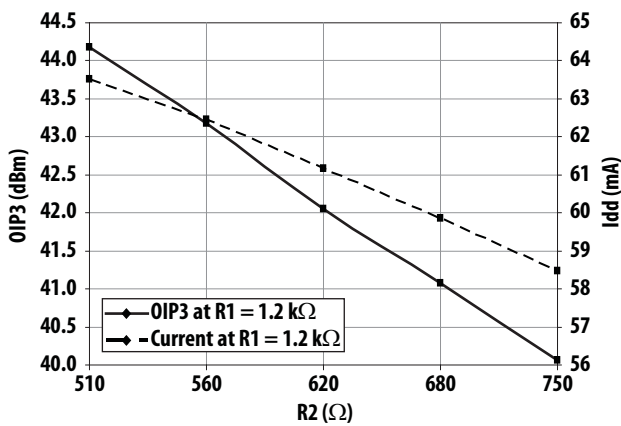

Figure 30. OIP3 and Quiescent Current with different R2^[1]

Note:

1. V_{bias} and V_{ctrl} can be externally controlled by change external biasing resistors $R1 = R_{bias}$ and $R2 = R_{ctrl}$ (as shown in Fig. 46).

MGA-31816 Application Circuit Data for 2.6 GHz

$T_C = 25^\circ\text{C}$, $V_{dd} = 5.0\text{V}$, $I_{dd} = 59\text{mA}$ (Based on BOM in Table 3, tuned for optimal linearity with over temperature)

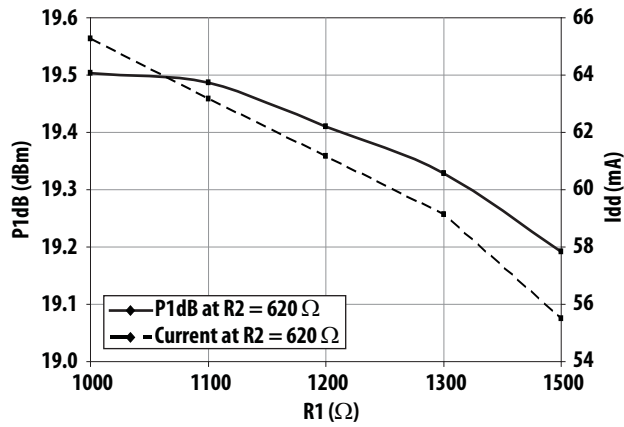

Figure 31. P1dB and Quiescent Current with different R1 [1]

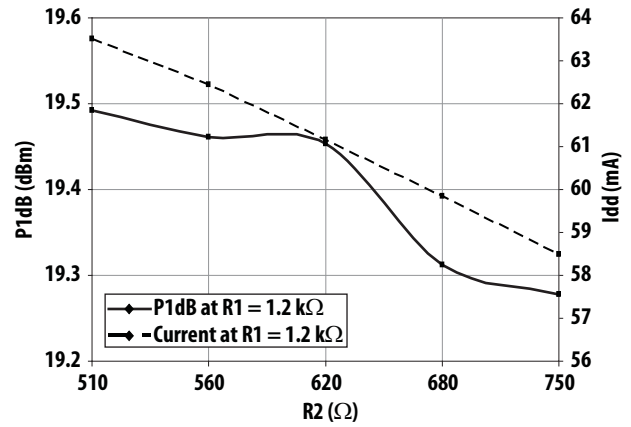

Figure 32. P1dB and Quiescent Current with different R2 [1]

Note:

1. V_{bias} and V_{ctrl} can be externally controlled by change external biasing resistors $R1 = R_{bias}$ and $R2 = R_{ctrl}$ (as shown in Fig. 46).

MGA-31816 Application Circuit Data for 3.5 GHz

$T_C = 25^\circ\text{C}$, $V_{dd} = 5.0\text{V}$, $I_{dd} = 59\text{mA}$ (Based on BOM in Table 3, tuned for optimal linearity with over temperature)

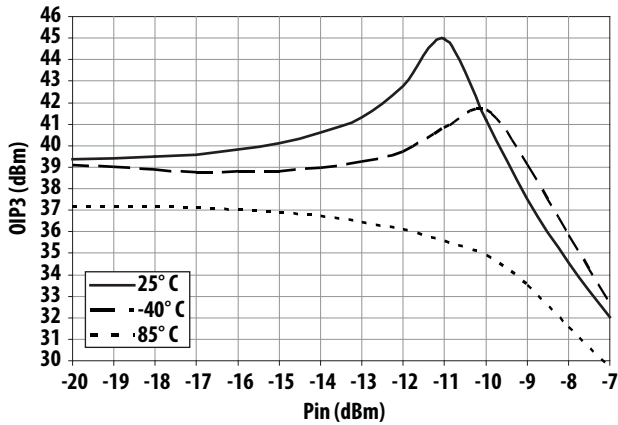

Figure 33. OIP3 vs Pin and Temperature

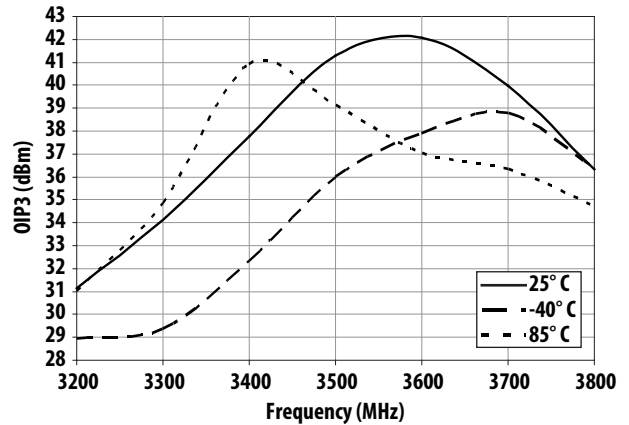

Figure 34. OIP3 vs Frequency and Temperature

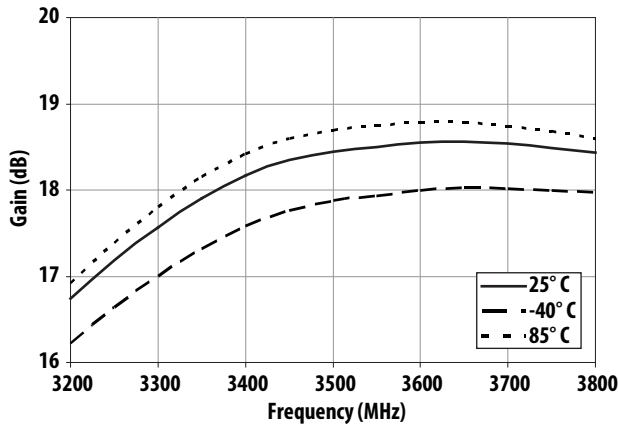

Figure 35. Gain vs Frequency and Temperature

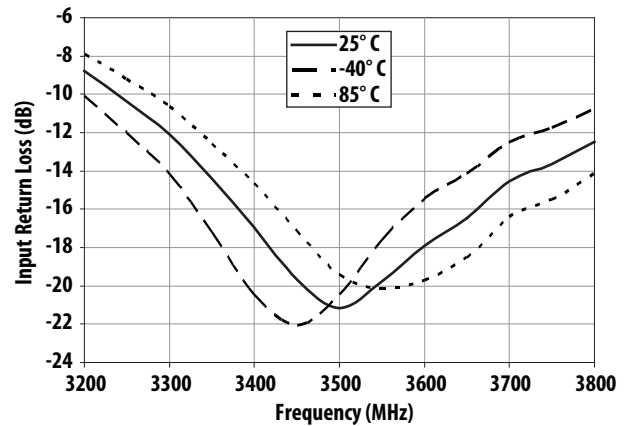

Figure 36. IRL vs Frequency and Temperature

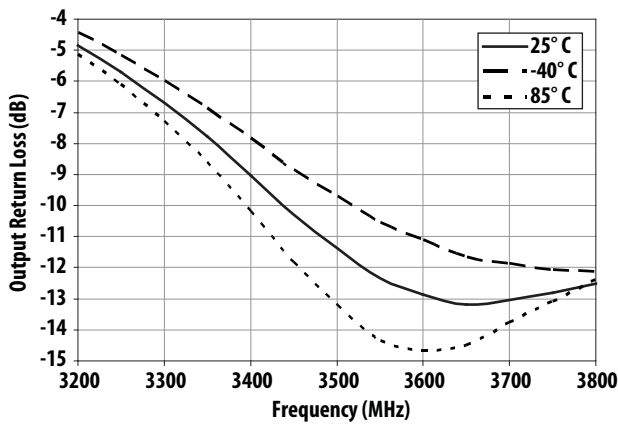

Figure 37. ORL vs Frequency and Temperature

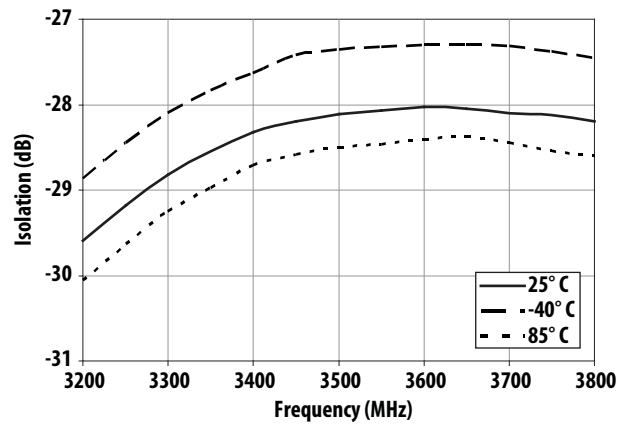

Figure 38. Isolation vs Frequency and Temperature

MGA-31816 Application Circuit Data for 3.5 GHz

$T_C = 25^\circ\text{C}$, $V_{dd} = 5.0\text{V}$, $I_{dd} = 59\text{mA}$ (Based on BOM in Table 3, tuned for optimal linearity with over temperature)

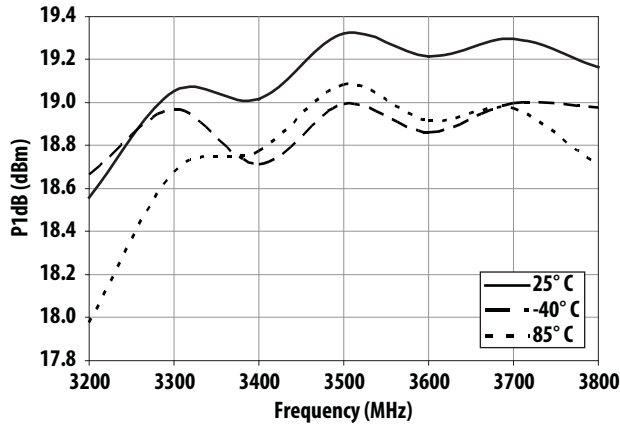

Figure 39. P1dB vs Frequency and Temperature

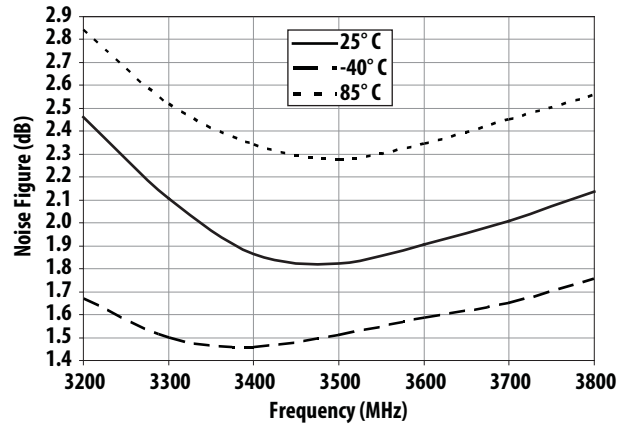

Figure 40. Noise Figure vs Frequency and Temperature

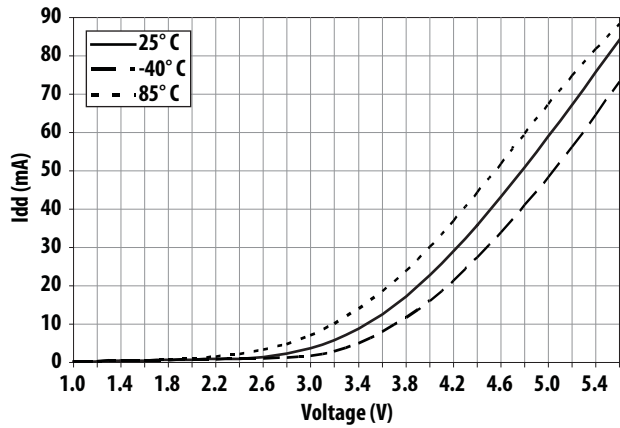

Figure 41. Current vs Voltage and Temperature

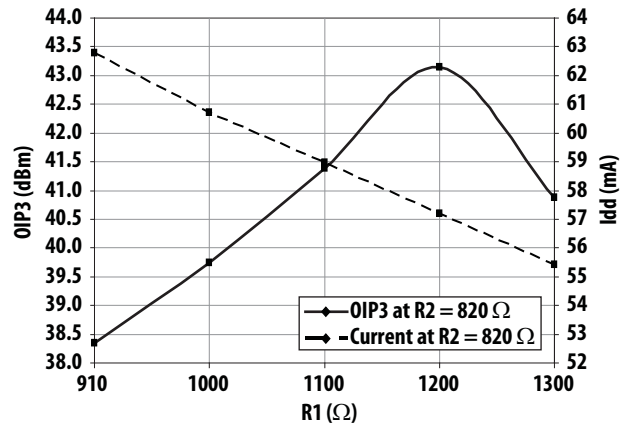

Figure 42. OIP3 and Quiescent Current with different R1^[1]

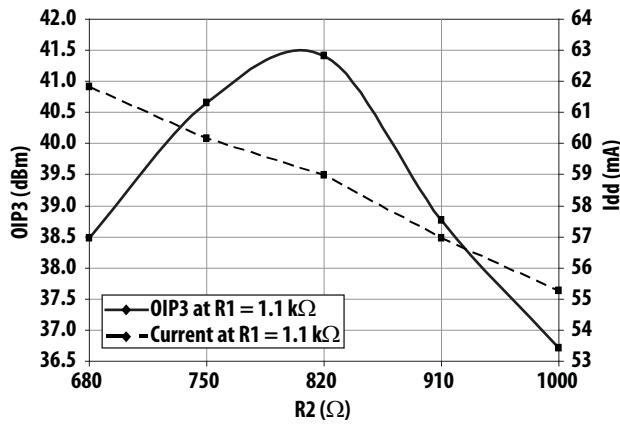

Figure 43. OIP3 and Quiescent Current with different R2^[1]

Note:

1. V_{bias} and V_{ctrl} can be externally controlled by change external biasing resistors $R1 = R_{bias}$ and $R2 = R_{ctrl}$ (as shown in Fig. 46).

MGA-31816 Application Circuit Data for 3.5 GHz

$T_C = 25^\circ\text{C}$, $V_{dd} = 5.0\text{V}$, $I_{dd} = 59\text{mA}$ (Based on BOM in Table 3, tuned for optimal linearity with over temperature)

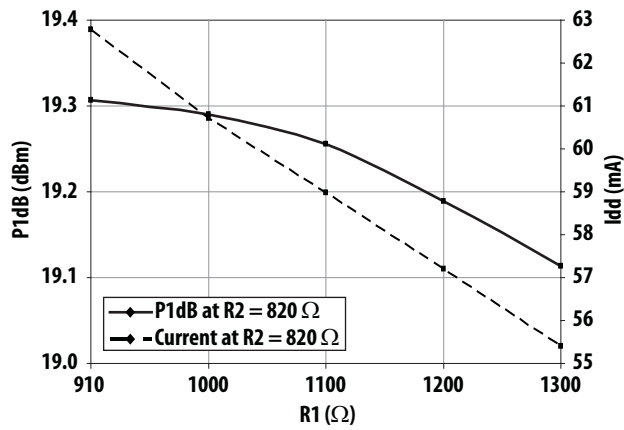

Figure 44. P1dB and Quiescent Current with different R1 [1]

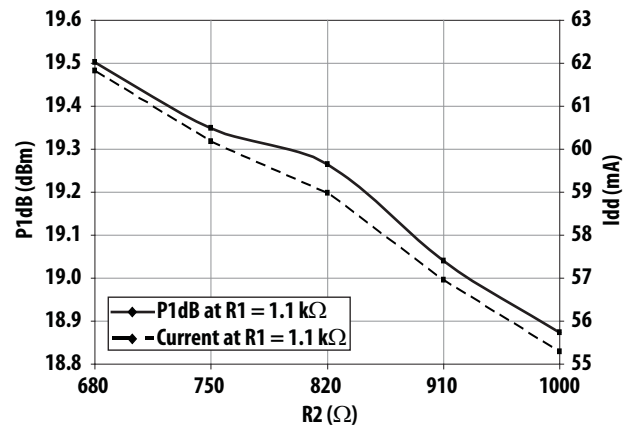

Figure 45. P1dB and Quiescent Current with different R2 [1]

Note:

- Vbias and Vctrl can be externally controlled by change external biasing resistors R1 = Rbias and R2 = Rctrl (as shown in Fig. 46).

Application Circuit Description and Layout

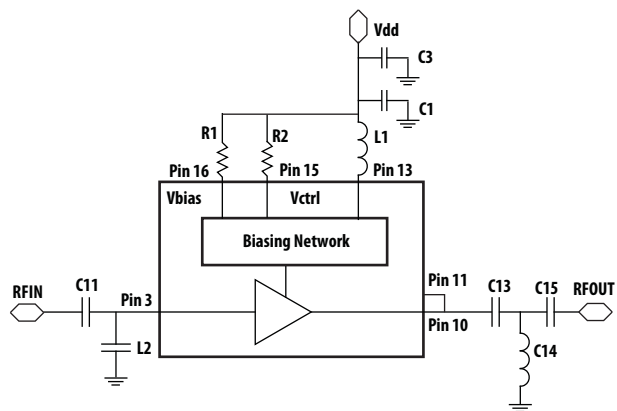

Figure 46. Circuit Diagram

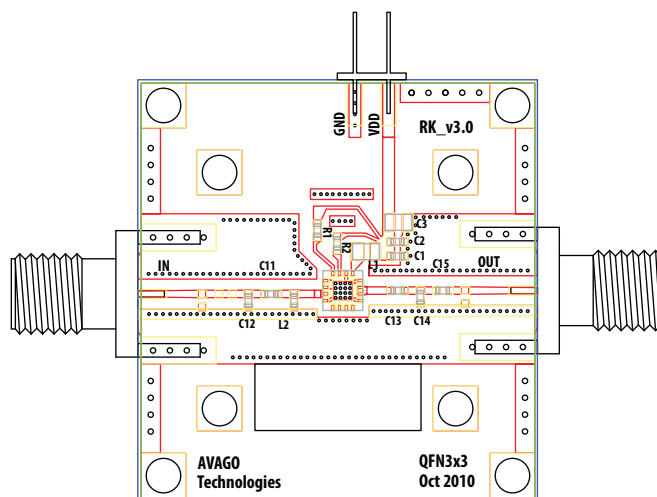

Figure 47. Demoboard

Table 3. Bill of Materials – Tuned for optimal linearity performance at different frequencies

Circuit Symbol	Size	Description		For 1900 MHz		For 2600 MHz		For 3500 MHz	
		Value	Manufacturer	Value	Manufacturer	Value	Manufacturer		
C2	0402	18 pF	Murata	12 pF	Murata	5 pF	Murata		
C3	0603	2.2 μ F	Murata	2.2 μ F	Murata	2.2 μ F	Murata		
C11	0402	NR	NR	5 pF	Murata	1 pF	Murata		
C13	0402	1.8 pF	Murata	0.75 pF	Murata	1.8 pF	Murata		
C14	0402	1 pF	Murata	NR	NR	1.8 nH	Murata		
C15	0402	NR	NR	NR	NR	0.7 pF	Murata		
L1	0402	1.8 pH	Murata	0 Ω	KOA	0 Ω	KOA		
L2	0402	1.3 pF	Murata	0.8 pF	Murata	0.6 pF	Murata		
R1 [1]	0402	820 Ω	KOA	1.2 k Ω	KOA	1.1 k Ω	KOA		
R2 [1]	0402	1 k Ω	KOA	620 Ω	KOA	820 Ω	KOA		

Notes:

NR – Not required in actual PCB design

1. R1 and R2 can be varied to bias Vbias and Vctrl which will provide flexibility to have the product operates at desirable Idd, LFOM, OIP3 drift across temperature and P1dB.
2. Capacitor is use at L2 and inductor is use at C14 for 3500MHz.

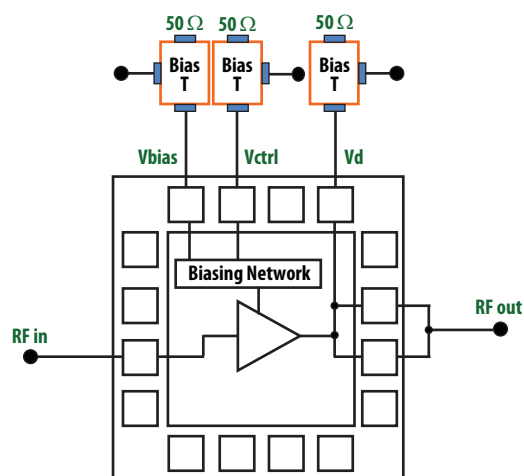

Note:

1. Measurements are conducted on 0.010 inch thick ROGER 4350. The input reference plane is at the end of the RFin pin and the output reference plane is at the end of the RFout pin as shown in Figure 48.

Figure 48. Circuit to measure de-embedded S-parameters and Noise Parameter in Table 4 and 5.

Table 4. MGA-31816 Typical Scattering Parameters

$T_C = 25^\circ\text{C}$, $V_{dd} = 5.0\text{V}$, $I_{dd} = 59\text{mA}$, $Z_o = 50\ \Omega$ (Data is de-embedded to the RFin & RFout pins on package. Measurements were made with Bias-T at V_{dd} , V_{ctrl} and V_{bias} in Figure 48)

Freq GHz	S11 Mag.	S11 dB	S11 Ang.	S21 Mag.	S21 dB	S21 Ang.	S12 Mag.	S12 dB	S12 Ang.	S22 Mag.	S22 dB	S22 Ang.	K Factor
0.10	0.919	-0.7	163.7	0.250	-12.0	-79.9	0.001	-57.2	143.7	0.781	-2.2	152.0	87.589
0.20	0.907	-0.8	147.4	0.776	-2.2	-80.7	0.005	-46.8	98.7	0.754	-2.5	122.7	11.054
0.30	0.890	-1.0	131.3	1.603	4.1	-95.7	0.008	-41.5	88.2	0.721	-2.9	93.1	4.096
0.40	0.862	-1.3	114.9	2.659	8.5	-115.4	0.014	-36.9	69.8	0.673	-3.4	63.1	2.276
0.50	0.823	-1.7	98.6	3.832	11.7	-137.1	0.021	-33.6	50.8	0.614	-4.2	32.3	1.693
0.60	0.773	-2.2	82.4	5.011	14.0	-159.4	0.027	-31.3	30.9	0.550	-5.2	1.5	1.452
0.70	0.719	-2.9	67.3	6.091	15.7	178.8	0.033	-29.5	10.8	0.486	-6.3	-29.1	1.315
0.80	0.664	-3.6	52.6	7.020	16.9	157.5	0.038	-28.4	-8.3	0.429	-7.4	-59.4	1.245
0.90	0.607	-4.3	38.9	7.769	17.8	137.0	0.042	-27.5	-26.6	0.379	-8.4	-88.7	1.204
1.00	0.558	-5.1	25.8	8.334	18.4	117.4	0.045	-26.9	-43.8	0.340	-9.4	-117.1	1.178
1.10	0.511	-5.8	13.4	8.791	18.9	98.9	0.048	-26.4	-61.1	0.309	-10.2	-143.6	1.158
1.20	0.472	-6.5	1.6	9.137	19.2	80.9	0.050	-26.1	-76.6	0.286	-10.9	-169.0	1.147
1.30	0.435	-7.2	-10.2	9.413	19.5	63.7	0.051	-25.8	-92.4	0.265	-11.5	167.3	1.140
1.40	0.403	-7.9	-21.3	9.626	19.7	46.9	0.052	-25.6	-107.2	0.251	-12.0	145.0	1.131
1.50	0.372	-8.6	-32.5	9.773	19.8	30.7	0.053	-25.5	-121.4	0.237	-12.5	124.1	1.131
1.60	0.346	-9.2	-42.9	9.882	19.9	14.8	0.054	-25.4	-135.6	0.225	-12.9	104.4	1.132
1.70	0.318	-9.9	-53.3	9.992	20.0	-1.0	0.054	-25.4	-149.5	0.216	-13.3	85.6	1.133
1.80	0.296	-10.6	-62.6	10.040	20.0	-16.4	0.054	-25.4	-163.2	0.205	-13.8	67.3	1.138
1.90	0.274	-11.3	-71.6	10.066	20.1	-31.6	0.054	-25.3	-176.0	0.193	-14.3	49.9	1.143
2.00	0.253	-12.0	-79.9	10.101	20.1	-46.7	0.054	-25.3	170.4	0.184	-14.7	33.7	1.145
2.10	0.237	-12.5	-87.0	10.090	20.1	-61.6	0.054	-25.3	157.8	0.174	-15.2	17.1	1.149
2.20	0.221	-13.1	-94.0	10.079	20.1	-76.4	0.054	-25.4	145.0	0.164	-15.7	1.8	1.158
2.30	0.210	-13.6	-98.8	10.056	20.1	-91.1	0.054	-25.4	131.7	0.154	-16.3	-13.4	1.165
2.40	0.204	-13.8	-103.1	9.969	20.0	-105.7	0.053	-25.5	119.4	0.144	-16.8	-27.1	1.179
2.50	0.204	-13.8	-107.9	9.922	20.0	-120.2	0.053	-25.6	107.0	0.133	-17.5	-41.6	1.183
3.00	0.254	-11.9	-134.8	9.361	19.4	168.2	0.049	-26.3	45.9	0.075	-22.5	-89.7	1.247
3.50	0.352	-9.1	-178.6	8.510	18.6	98.1	0.043	-27.3	-12.9	0.084	-21.5	-79.3	1.338
4.00	0.448	-7.0	129.0	7.488	17.5	29.9	0.037	-28.7	-68.6	0.181	-14.8	-117.4	1.488
5.00	0.582	-4.7	14.5	5.425	14.7	-100.9	0.028	-31.2	-170.5	0.358	-8.9	130.6	1.885
6.00	0.677	-3.4	-104.3	3.873	11.8	135.0	0.023	-32.8	97.5	0.431	-7.3	16.2	2.316
7.00	0.749	-2.5	139.9	2.729	8.7	15.0	0.023	-32.9	8.0	0.467	-6.6	-99.4	2.491
8.00	0.787	-2.1	30.3	1.913	5.6	-99.7	0.022	-33.1	-90.8	0.495	-6.1	146.2	3.046
9.00	0.799	-2.0	-75.6	1.398	2.9	148.5	0.024	-32.3	173.1	0.526	-5.6	36.4	3.452
10.00	0.794	-2.0	178.9	1.046	0.4	38.7	0.026	-31.6	71.8	0.549	-5.2	-70.1	4.257
11.00	0.797	-2.0	70.7	0.812	-1.8	-70.3	0.028	-31.0	-30.6	0.546	-5.3	-173.8	5.165
12.00	0.816	-1.8	-37.9	0.629	-4.0	-179.6	0.030	-30.6	-136.3	0.526	-5.6	78.1	6.052
13.00	0.827	-1.7	-139.4	0.470	-6.6	72.4	0.029	-30.9	116.0	0.535	-5.4	-35.5	7.992
14.00	0.829	-1.6	125.2	0.358	-8.9	-28.5	0.024	-32.4	27.4	0.567	-4.9	-146.5	11.988
15.00	0.801	-1.9	22.2	0.311	-10.1	-134.6	0.029	-30.7	-80.8	0.601	-4.4	110.9	12.115
16.00	0.790	-2.1	-91.7	0.249	-12.1	113.3	0.030	-30.4	166.6	0.619	-4.2	4.7	14.902
17.00	0.810	-1.8	162.7	0.163	-15.8	0.5	0.025	-32.2	50.9	0.661	-3.6	-111.2	23.713
18.00	0.824	-1.7	68.3	0.071	-22.9	-99.0	0.013	-37.6	-50.7	0.728	-2.8	130.8	79.608
19.00	0.820	-1.7	-27.4	0.047	-26.6	-95.2	0.007	-43.2	-78.2	0.788	-2.1	12.8	193.344
20.00	0.809	-1.8	-130.0	0.152	-16.3	151.9	0.033	-29.7	-165.6	0.676	-3.4	-103.2	19.267

MGA-31816 Stability

$T_C = 25^\circ\text{C}$, $V_{dd} = 5.0\text{V}$, $I_{dd} = 59\text{mA}$, $Z_o = 50\ \Omega$ (Data is de-embedded to the RFin & RFout pins on package. Measurements were made with Bias-T at V_{dd} , V_{ctrl} and V_{bias} in Figure 48)

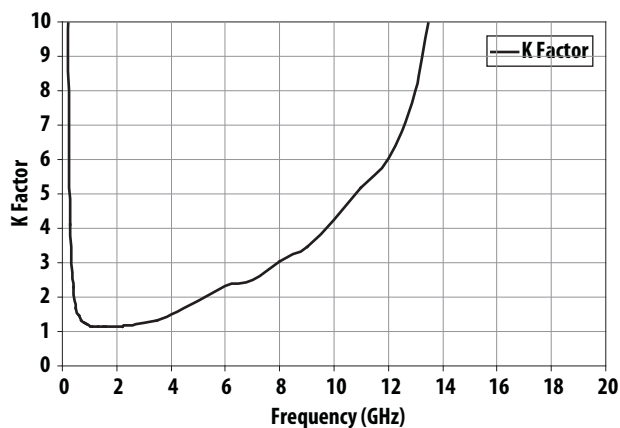

Figure 49. K-Factor vs Frequency

Table 5. MGA-31816 Typical Noise Parameters

$T_C = 25^\circ\text{C}$, $V_{dd} = 5.0\text{V}$, $I_{dd} = 59\text{mA}$, $Z_o = 50\ \Omega$ (Data is de-embedded to the RFin & RFout pins on package. Measurements were made with Bias-T at V_{dd} , V_{ctrl} and V_{bias} in Figure 48)

Freq (GHz)	F_{min} (dB)	Γ_{opt} Mag	Γ_{opt} Ang	R_n/Z_0	G_a (dB)
0.5	3.52	0.805	-152.5	0.2802	18.93
0.8	2.15	0.65	-142.8	0.181	20.34
0.9	1.92	0.617	-140.5	0.1648	20.50
1.0	1.79	0.586	-140.1	0.1554	20.61
1.5	1.44	0.49	-132.5	0.1278	20.85
2.0	1.35	0.425	-129.3	0.121	20.82
2.5	1.28	0.385	-125.1	0.118	20.65
3.0	1.29	0.35	-120.4	0.1202	20.43
3.5	1.35	0.38	-121.4	0.128	20.05
4.0	1.48	0.428	-119.9	0.1412	19.64
4.5	1.61	0.477	-118.1	0.151	19.22
5.0	1.82	0.552	-112.5	0.1782	18.80
5.5	2.02	0.599	-99.8	0.203	18.39
6.0	2.22	0.635	-90.4	0.2528	17.98

PCB Layout and Stencil Design

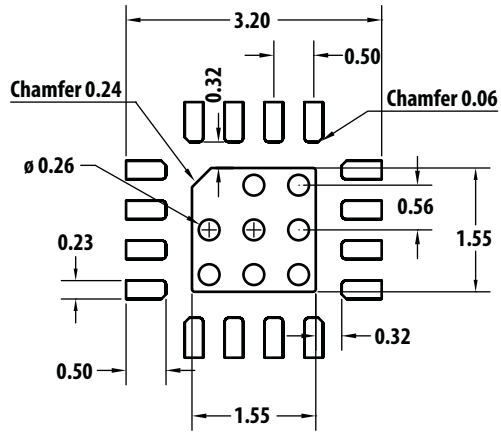

PCB LAND PATTERN (TOP VIEW)

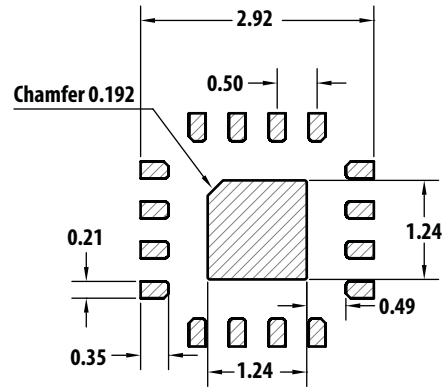

STENCIL OUTLINE

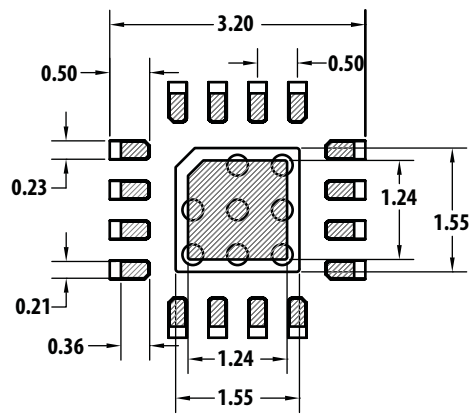

COMBINED PCB & STENCIL LAYOUTS

Notes:

1. All dimensions are in millimeters
2. 4mil stencil thickness recommended

Package Dimensions

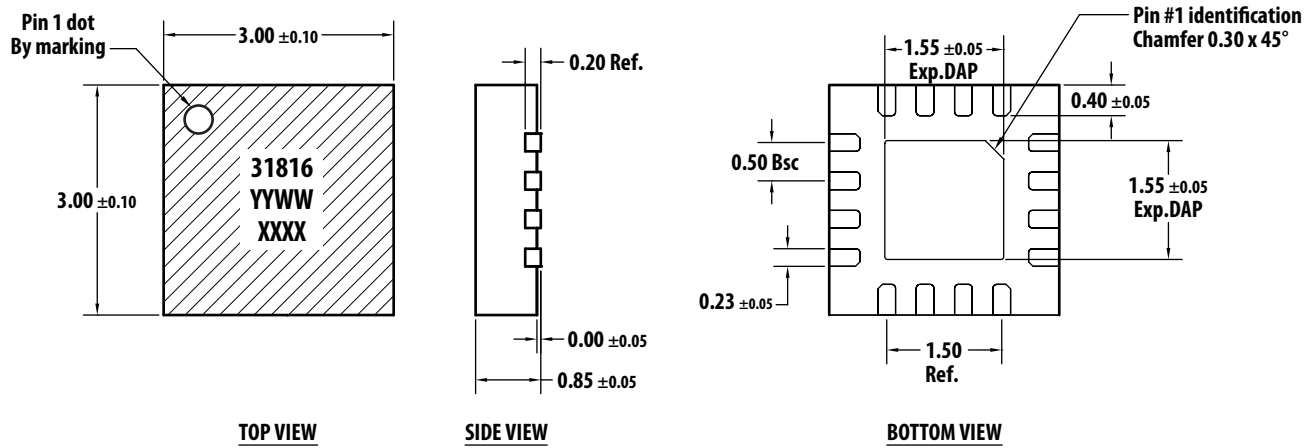

Notes:

1. All dimensions are in millimeters.
2. Dimensions are inclusive of plating.
3. Dimensions are exclusive of mold flash and metal burr.

Part Number Ordering Information

Part Number	No. of Devices	Container
MGA-31816-BLKG	100	Antistatic Bag
MGA-31816-TR1G	3000	13" Tape/Reel

Device Orientation

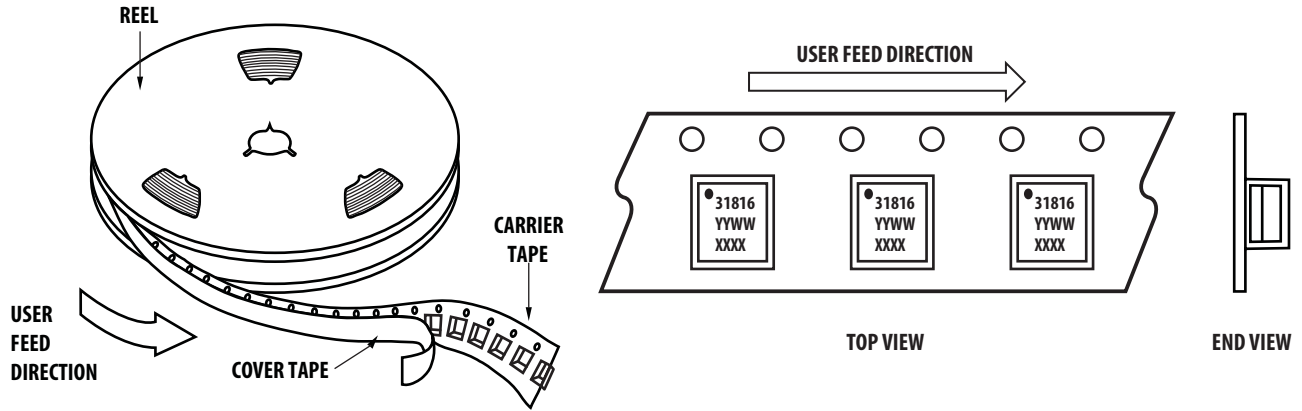

Tape Dimensions

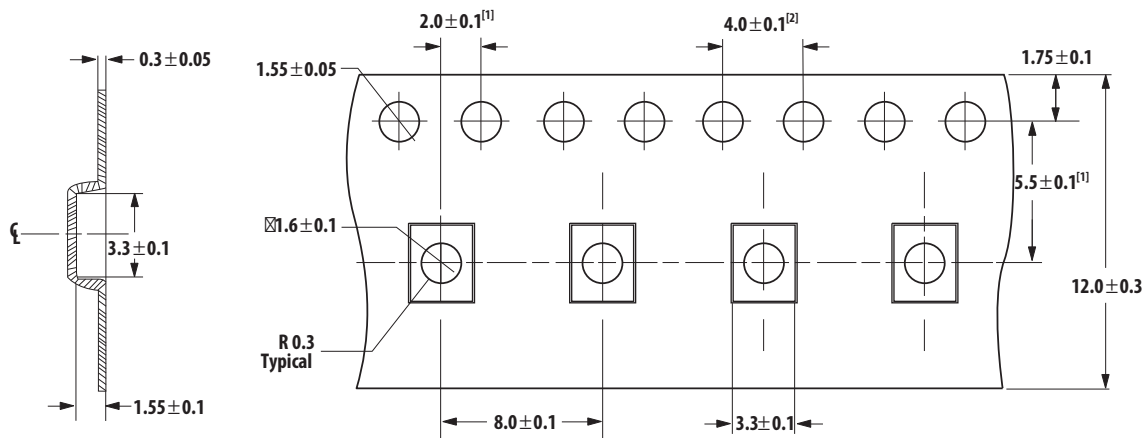

Notes:

1. Measured from centerline of sprocket hole to centerline of pocket
2. Cumulative tolerance of 10 sprocket holes is ±0.20
3. Other material available
4. All dimensions in millimeter unless otherwise stated

Reel Dimension – 13" Reel 12 mm Width

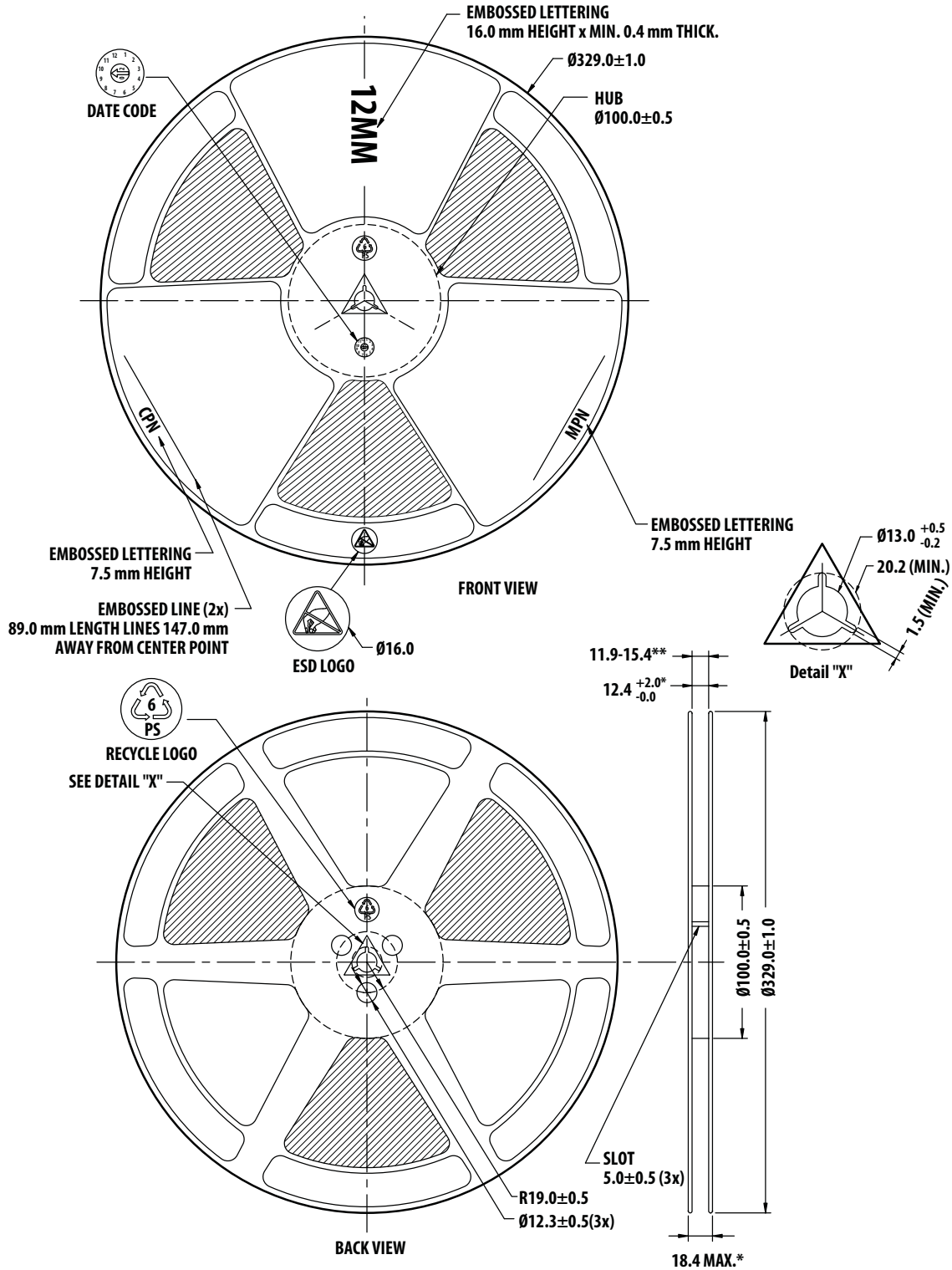

For product information and a complete list of distributors, please go to our web site: www.avagotech.com

Avago, Avago Technologies, and the A logo are trademarks of Avago Technologies in the United States and other countries. Data subject to change. Copyright © 2005-2012 Avago Technologies. All rights reserved. AV02-3265EN - March 8, 2012

