



August 2014

# FGH25T120SMD

## 1200 V, 25 A Field Stop Trench IGBT

### Features

- FS Trench Technology, Positive Temperature Coefficient
- High Speed Switching
- Low Saturation Voltage:  $V_{CE(sat)} = 1.8\text{ V}$  @  $I_C = 25\text{ A}$
- 100% of The Parts Tested for  $I_{LM}(1)$
- High Input Impedance
- RoHS Compliant

### General Description

Using innovative field stop trench IGBT technology, Fairchild's new series of field stop trench IGBTs offer the optimum performance for hard switching application such as solar inverter, UPS, welder and PFC applications.

### Applications

- Solar Inverter, Welder, UPS & PFC Applications.

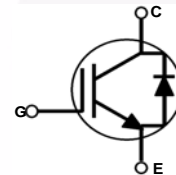
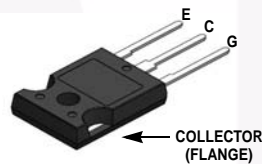

### Absolute Maximum Ratings $T_C = 25^\circ\text{C}$ unless otherwise noted

| Symbol      | Description   | Ratings     | Unit             |
|-------------|---|-------------|------------------|
| $V_{CES}$   | Collector to Emitter Voltage  | 1200        | V                |
| $V_{GES}$   | Gate to Emitter Voltage   | $\pm 25$    | V                |
|             | Transient Gate to Emitter Voltage                                       | $\pm 30$    | V                |
| $I_C$       | Collector Current @ $T_C = 25^\circ\text{C}$                            | 50          | A                |
|             | Collector Current @ $T_C = 100^\circ\text{C}$                           | 25          | A                |
| $I_{LM}(1)$ | Clamped Inductive Load Current @ $T_C = 25^\circ\text{C}$               | 100         | A                |
| $I_{CM}(2)$ | Pulsed Collector Current  | 100         | A                |
| $I_F$       | Diode Continuous Forward Current @ $T_C = 25^\circ\text{C}$             | 50          | A                |
|             | Diode Continuous Forward Current @ $T_C = 100^\circ\text{C}$            | 25          | A                |
| $I_{FM}$    | Diode Maximum Forward Current   | 200         | A                |
| $P_D$       | Maximum Power Dissipation @ $T_C = 25^\circ\text{C}$                    | 428         | W                |
|             | Maximum Power Dissipation @ $T_C = 100^\circ\text{C}$                   | 214         | W                |
| $T_J$       | Operating Junction Temperature  | -55 to +175 | $^\circ\text{C}$ |
| $T_{stg}$   | Storage Temperature Range   | -55 to +175 | $^\circ\text{C}$ |
| $T_L$       | Maximum Lead Temp. for soldering Purposes, 1/8" from case for 5 seconds | 300         | $^\circ\text{C}$ |

### Thermal Characteristics

| Symbol                        | Parameter                               | Typ. | Max. | Unit                      |
|-------------------------------|---|------|------|---------------------------|
| $R_{\theta JC}(\text{IGBT})$  | Thermal Resistance, Junction to Case    | --   | 0.35 | $^\circ\text{C}/\text{W}$ |
| $R_{\theta JC}(\text{Diode})$ | Thermal Resistance, Junction to Case    | --   | 1.4  | $^\circ\text{C}/\text{W}$ |
| $R_{\theta JA}$               | Thermal Resistance, Junction to Ambient | --   | 40   | $^\circ\text{C}/\text{W}$ |

**Notes:**  
 1.  $V_{CC} = 600\text{ V}$ ,  $V_{GE} = 15\text{ V}$ ,  $I_C = 100\text{ A}$ ,  $R_G = 23\ \Omega$ , Inductive Load  
 2. Limited by  $T_{jmax}$

### Package Marking and Ordering Information

| Device Marking | Device            | Package   | Reel Size | Tape Width | Quantity |
|----------------|-------------------|-----------|-----------|------------|----------|
| FGH25T120SMD   | FGH25T120SMD_F155 | TO-247G03 | -         | -          | 30       |

### Electrical Characteristics of the IGBT T<sub>C</sub> = 25°C unless otherwise noted

| Symbol                           | Parameter                               | Test Conditions   | Min. | Typ. | Max. | Unit |
|----------------------------------|---|---|------|------|------|------|
| <b>Off Characteristics</b>       |   |   |      |      |      |      |
| BV <sub>CES</sub>                | Collector to Emitter Breakdown Voltage  | V <sub>GE</sub> = 0 V, I <sub>C</sub> = 250 μA  | 1200 | -    | -    | V    |
| I <sub>CES</sub>                 | Collector Cut-Off Current               | V <sub>CE</sub> = V <sub>CES</sub> , V <sub>GE</sub> = 0 V  | -    | -    | 250  | μA   |
| I <sub>GES</sub>                 | G-E Leakage Current                     | V <sub>GE</sub> = V <sub>GES</sub> , V <sub>CE</sub> = 0 V  | -    | -    | ±400 | nA   |
| <b>On Characteristics</b>        |   |   |      |      |      |      |
| V <sub>GE(th)</sub>              | G-E Threshold Voltage                   | I <sub>C</sub> = 25 mA, V <sub>CE</sub> = V <sub>GE</sub>   | 4.9  | 6.2  | 7.5  | V    |
| V <sub>CE(sat)</sub>             | Collector to Emitter Saturation Voltage | I <sub>C</sub> = 25 A, V <sub>GE</sub> = 15 V<br>T <sub>C</sub> = 25°C  | -    | 1.8  | 2.4  | V    |
|                                  |   | I <sub>C</sub> = 25 A, V <sub>GE</sub> = 15 V,<br>T <sub>C</sub> = 175°C  | -    | 1.9  | -    | V    |
| <b>Dynamic Characteristics</b>   |   |   |      |      |      |      |
| C <sub>ies</sub>                 | Input Capacitance                       | V <sub>CE</sub> = 30 V, V <sub>GE</sub> = 0 V,<br>f = 1MHz  | -    | 2800 | -    | pF   |
| C <sub>oes</sub>                 | Output Capacitance                      |   | -    | 105  | -    | pF   |
| C <sub>res</sub>                 | Reverse Transfer Capacitance            |   | -    | 60   | -    | pF   |
| <b>Switching Characteristics</b> |   |   |      |      |      |      |
| t <sub>d(on)</sub>               | Turn-On Delay Time                      | V <sub>CC</sub> = 600 V, I <sub>C</sub> = 25 A,<br>R <sub>G</sub> = 23 Ω, V <sub>GE</sub> = 15 V,<br>Inductive Load, T <sub>C</sub> = 25°C  | -    | 40   | -    | ns   |
| t <sub>r</sub>                   | Rise Time                               |   | -    | 45   | -    | ns   |
| t <sub>d(off)</sub>              | Turn-Off Delay Time                     |   | -    | 490  | -    | ns   |
| t <sub>f</sub>                   | Fall Time                               |   | -    | 12   | -    | ns   |
| E <sub>on</sub>                  | Turn-On Switching Loss                  |   | -    | 1.74 | -    | mJ   |
| E <sub>off</sub>                 | Turn-Off Switching Loss                 |   | -    | 0.56 | -    | mJ   |
| E <sub>ts</sub>                  | Total Switching Loss                    |   | -    | 2.30 | -    | mJ   |
| t <sub>d(on)</sub>               | Turn-On Delay Time                      | V <sub>CC</sub> = 600 V, I <sub>C</sub> = 25 A,<br>R <sub>G</sub> = 23 Ω, V <sub>GE</sub> = 15 V,<br>Inductive Load, T <sub>C</sub> = 175°C | -    | 40   | -    | ns   |
| t <sub>r</sub>                   | Rise Time                               |   | -    | 48   | -    | ns   |
| t <sub>d(off)</sub>              | Turn-Off Delay Time                     |   | -    | 520  | -    | ns   |
| t <sub>f</sub>                   | Fall Time                               |   | -    | 64   | -    | ns   |
| E <sub>on</sub>                  | Turn-On Switching Loss                  |   | -    | 2.94 | -    | mJ   |
| E <sub>off</sub>                 | Turn-Off Switching Loss                 |   | -    | 1.09 | -    | mJ   |
| E <sub>ts</sub>                  | Total Switching Loss                    |   | -    | 4.03 | -    | mJ   |
| Q <sub>g</sub>                   | Total Gate Charge                       | V <sub>CE</sub> = 600 V, I <sub>C</sub> = 25 A,<br>V <sub>GE</sub> = 15 V   | -    | 225  | -    | nC   |
| Q <sub>ge</sub>                  | Gate to Emitter Charge                  |   | -    | 20   | -    | nC   |
| Q <sub>gc</sub>                  | Gate to Collector Charge                |   | -    | 128  | -    | nC   |

**Electrical Characteristics of the DIODE**  $T_C = 25^\circ\text{C}$  unless otherwise noted

| Symbol    | Parameter                           | Test Conditions  | Min. | Typ. | Max. | Unit          |
|-----------|-------------------------------------|--|------|------|------|---------------|
| $V_{FM}$  | Diode Forward Voltage               | $I_F = 25\text{ A}, T_C = 25^\circ\text{C}$  | -    | 2.8  | 3.7  | V             |
|           |                                     | $I_F = 25\text{ A}, T_C = 175^\circ\text{C}$   | -    | 2.1  | -    | V             |
| $t_{rr}$  | Diode Reverse Recovery Time         | $V_R = 600\text{ V}, I_F = 25\text{ A},$<br>$di_F/dt = 200\text{ A/us}, T_C = 25^\circ\text{C}$  | -    | 60   | -    | ns            |
| $I_{rr}$  | Diode Peak Reverse Recovery Current |  | -    | 6.6  | -    | A             |
| $Q_{rr}$  | Diode Reverse Recovery Charge       |  | -    | 197  | -    | nC            |
| $E_{rec}$ | Reverse Recovery Energy             | $V_R = 600\text{ V}, I_F = 25\text{ A},$<br>$di_F/dt = 200\text{ A/us}, T_C = 175^\circ\text{C}$ | -    | 330  | -    | $\mu\text{J}$ |
| $t_{rr}$  | Diode Reverse Recovery Time         |  | -    | 325  | -    | ns            |
| $I_{rr}$  | Diode Peak Reverse Recovery Current |  | -    | 13   | -    | A             |
| $Q_{rr}$  | Diode Reverse Recovery Charge       |  | -    | 2113 | -    | nC            |



## Typical Performance Characteristics

Figure 1. Typical Output Characteristics

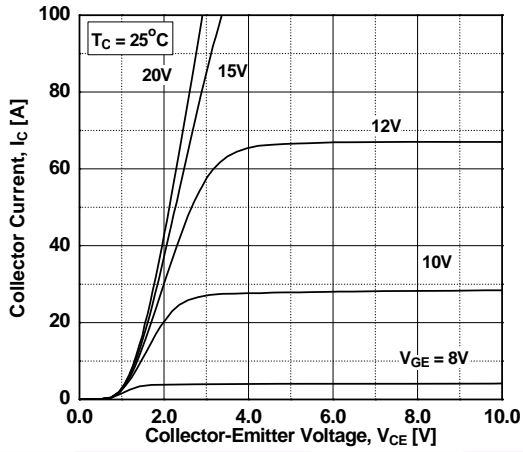

Figure 2. Typical Output Characteristics

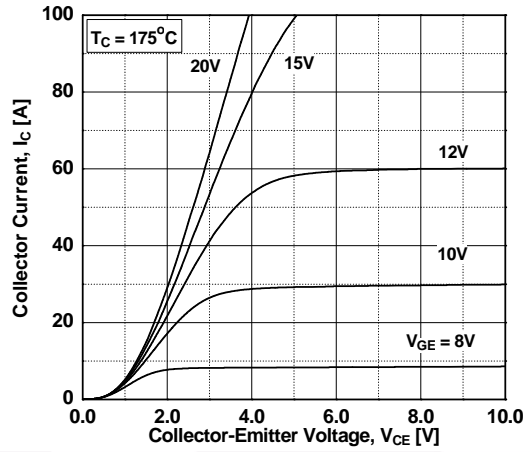

Figure 3. Typical Saturation Voltage Characteristics

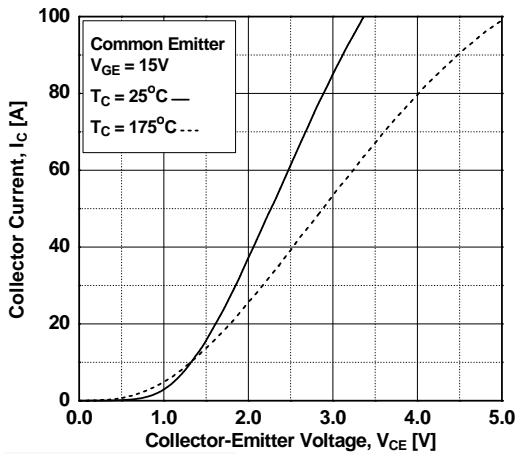

Figure 4. Saturation Voltage vs. Case Temperature at Variant Current Level

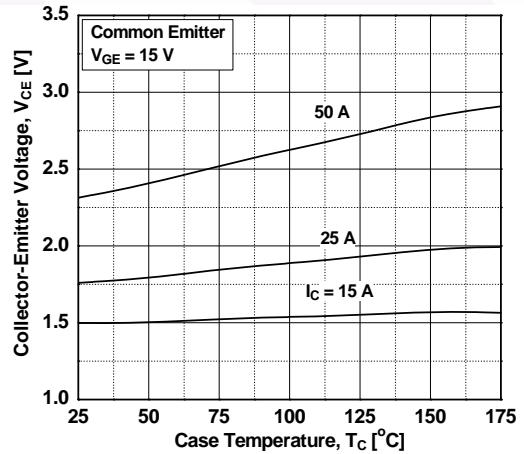

Figure 5. Saturation Voltage vs. Vge

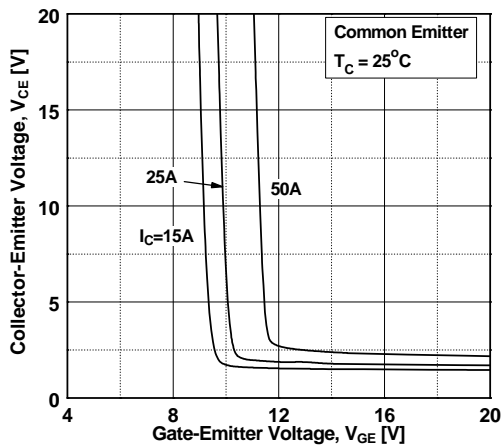
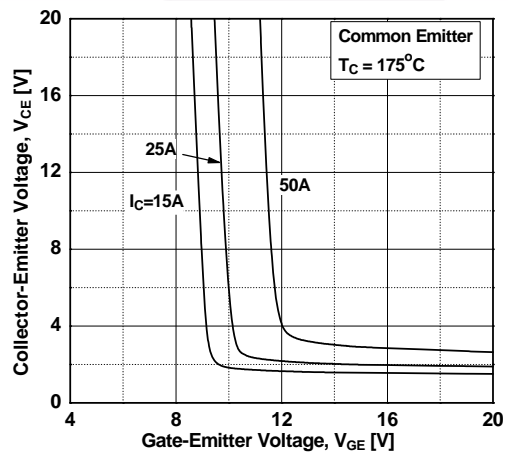
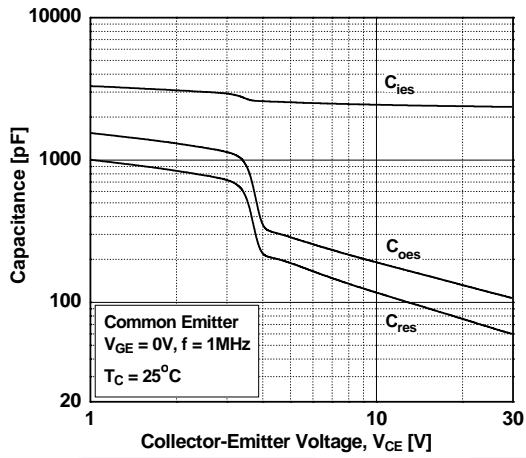

Figure 6. Saturation Voltage vs. Vge



## Typical Performance Characteristics

**Figure 7. Capacitance Characteristics**



**Figure 8. Gate Charge Characteristics**

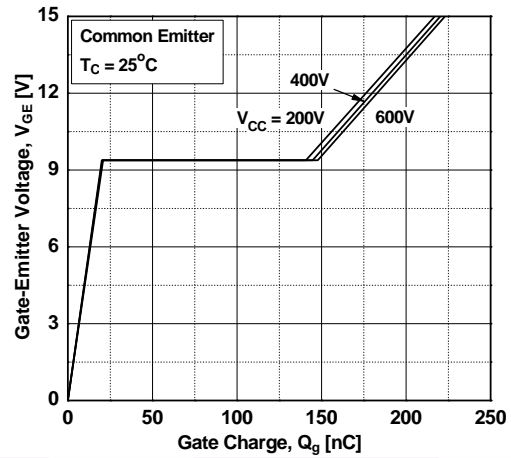

**Figure 9. Turn-on Characteristics vs. Gate Resistance**

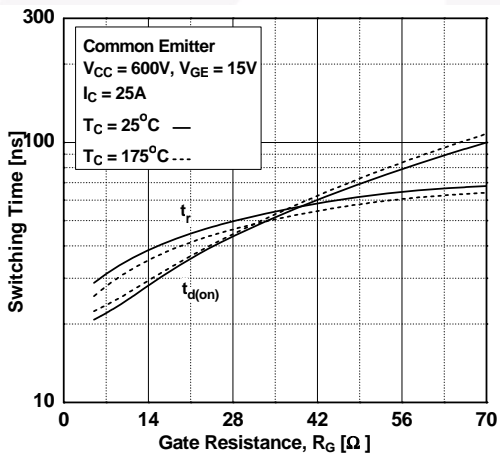

**Figure 10. Turn-off Characteristics vs. Gate Resistance**

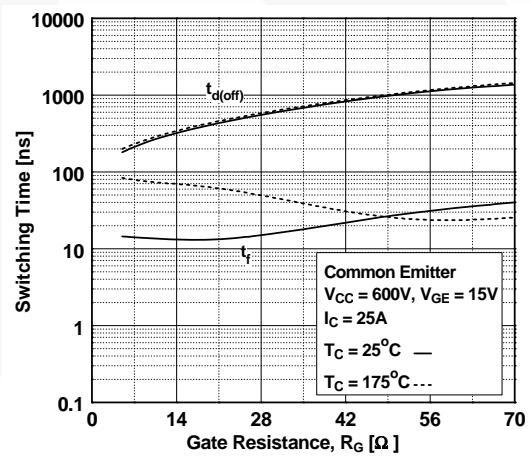

**Figure 11. Switching Loss vs. Gate Resistance**

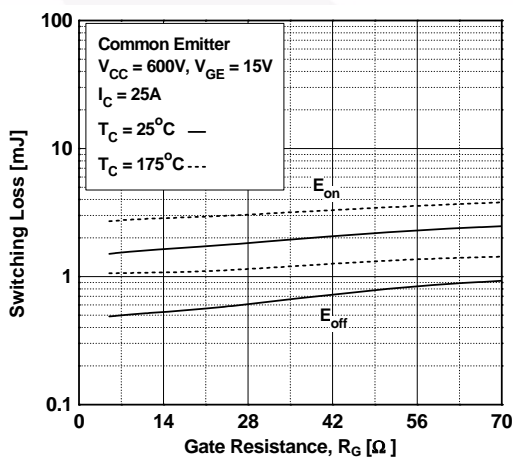

**Figure 12. Turn-on Characteristics vs. Collector Current**

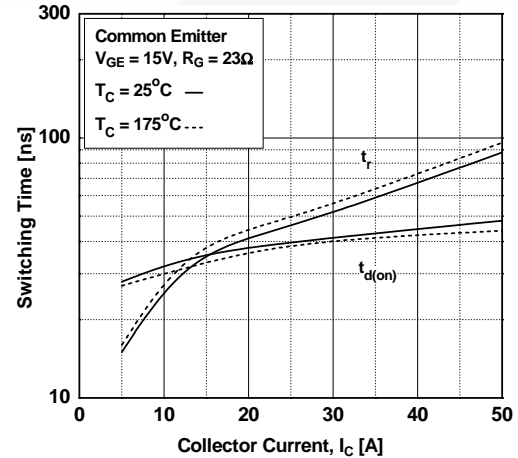

## Typical Performance Characteristics

Figure 13. Turn-off Characteristics vs. Collector Current

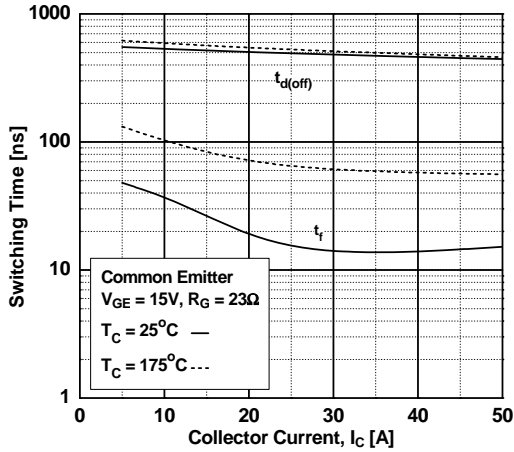

Figure 14. Switching Loss vs. Collector Current

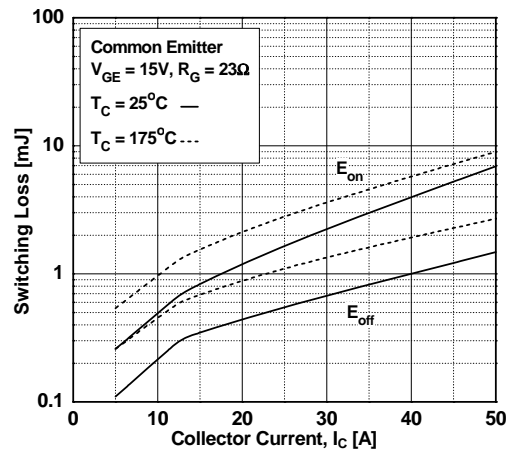

Figure 15. Load Current vs. Frequency

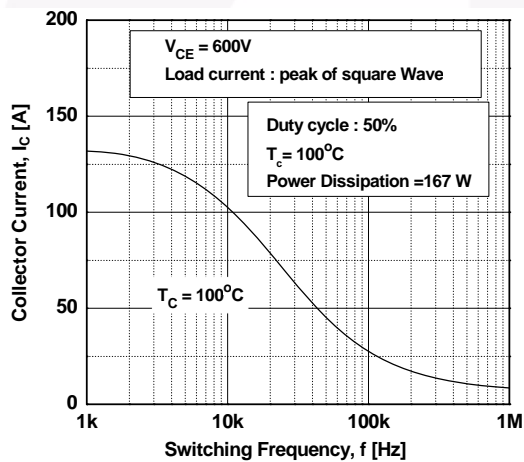

Figure 16. SOA Characteristics

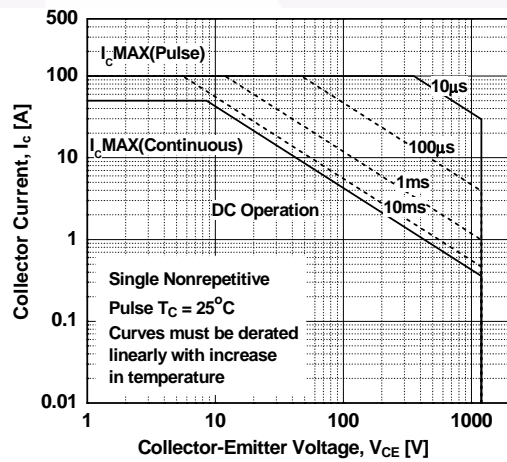

Figure 17. Forward Characteristics

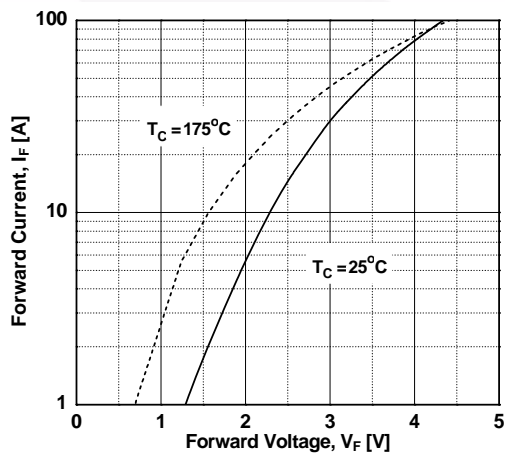
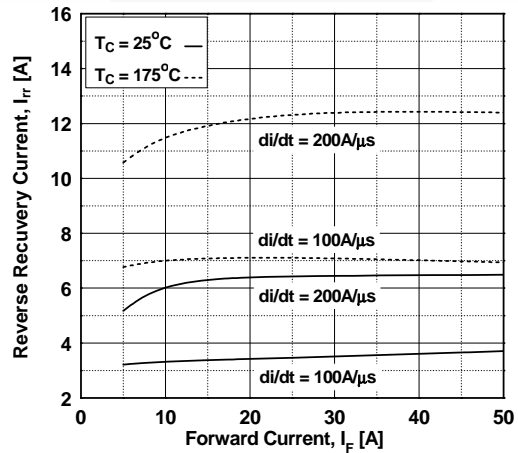

Figure 18. Reverse Recovery Current



## Typical Performance Characteristics

Figure 19. Reverse Recovery Time

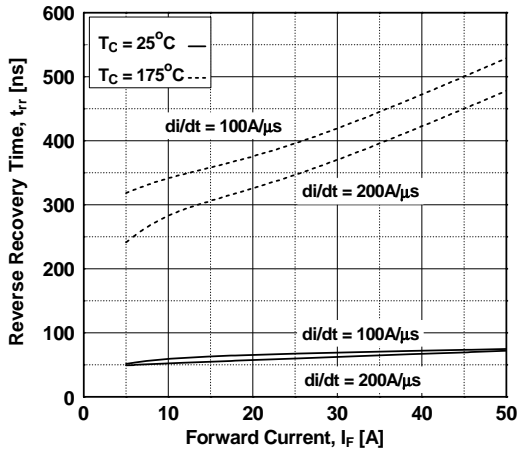

Figure 20. Stored Charge

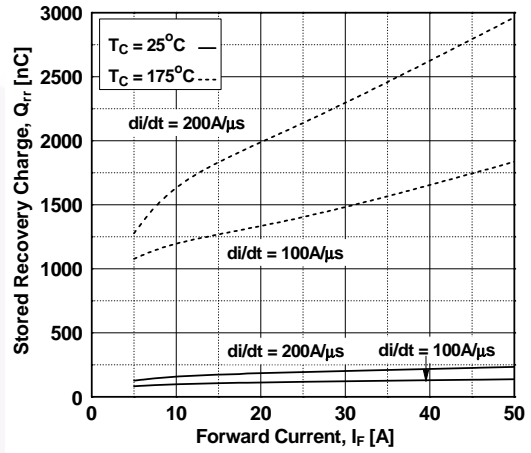

Figure 21. Transient Thermal Impedance of IGBT

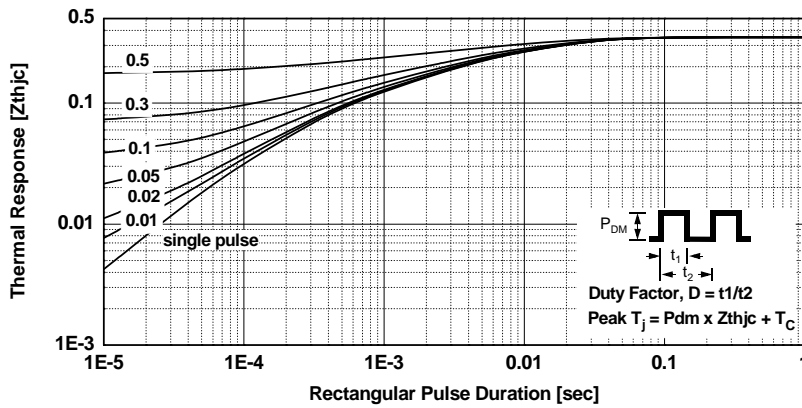
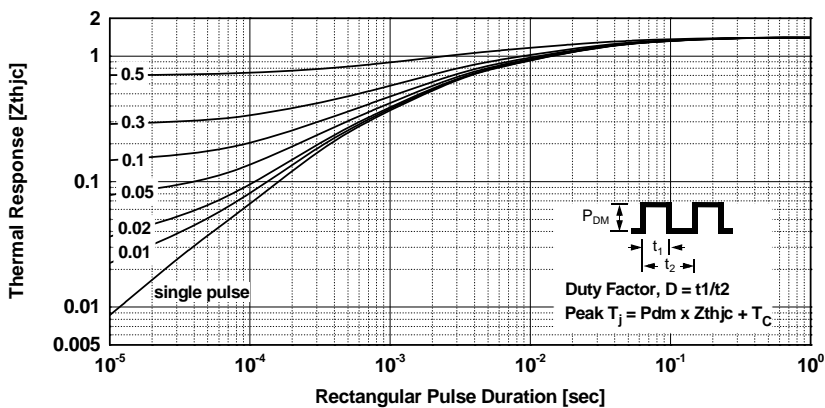
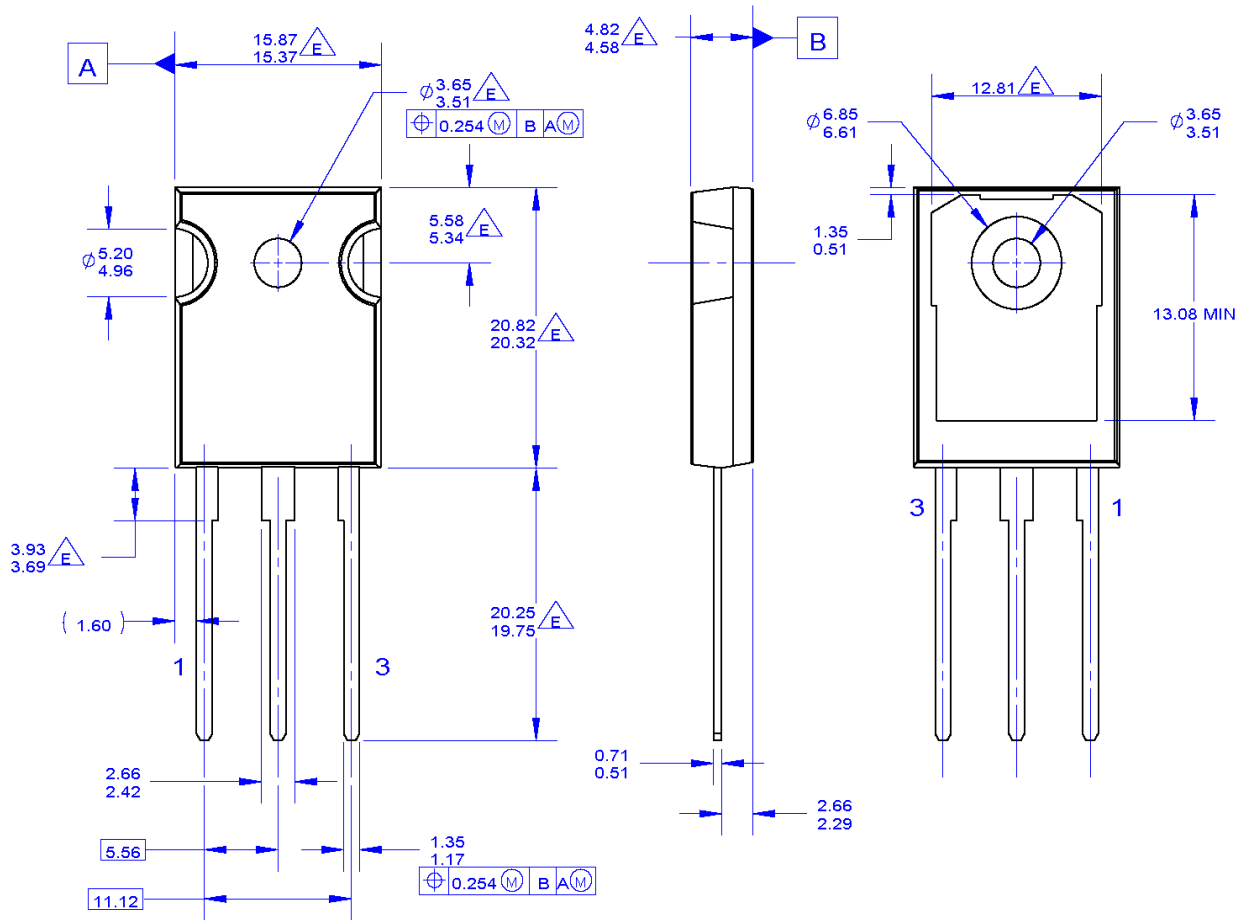

Figure 22. Transient Thermal Impedance of Diode



## Mechanical Dimensions



NOTES: UNLESS OTHERWISE SPECIFIED.

- A. PACKAGE REFERENCE: JEDEC TO-247, ISSUE E, VARIATION AB, DATED JUNE, 2004.
- B. DIMENSIONS ARE EXCLUSIVE OF BURRS, MOLD FLASH, AND TIE BAR EXTRUSIONS.
- C. ALL DIMENSIONS ARE IN MILLIMETERS.
- D. DRAWING CONFORMS TO ASME Y14.5 - 1994

- DOES NOT COMPLY JEDEC STANDARD VALUE
- F. DRAWING FILENAME: MKT-TO247G03\_REV01

**Figure 23. TO-247, MOLDED, 3 LEAD, JEDEC AB LONG LEADS (Active)**

Package drawings are provided as a service to customers considering Fairchild components. Drawings may change in any manner without notice. Please note the revision and/or date on the drawing and contact a Fairchild Semiconductor representative to verify or obtain the most recent revision. Package specifications do not expand the terms of Fairchild's worldwide terms and conditions, specifically the warranty therein, which covers Fairchild products.

Always visit Fairchild Semiconductor's online packaging area for the most recent package drawings:

[http://www.fairchildsemi.com/package/packageDetails.html?id=PN\\_TO247-0A3](http://www.fairchildsemi.com/package/packageDetails.html?id=PN_TO247-0A3)

Dimensions in Millimeters





**TRADEMARKS**

The following includes registered and unregistered trademarks and service marks, owned by Fairchild Semiconductor and/or its global subsidiaries, and is not intended to be an exhaustive list of all such trademarks.

- |                          |   |                             |                  |
|--------------------------|---|-----------------------------|------------------|
| AccuPower™               | F-PFST™   | PowerTrench®                | SYSTEM GENERAL®  |
| AX-CAP®*                 | FRFET®  | PowerXS™                    | TinyBoost®       |
| BitSiC™                  | Global Power ResourceSM                         | Programmable Active Droop™  | TinyBuck®        |
| Build it Now™            | GreenBridge™                                    | QFET®                       | TinyCalc™        |
| CorePLUS™                | Green FPS™                                      | QS™                         | TinyLogic®       |
| CorePOWER™               | Green FPS™ e-Series™                            | Quiet Series™               | TINYOPTO™        |
| CROSSVOL™                | Gmax™   | RapidConfigure™             | TinyPower™       |
| CTL™                     | GTO™  | SignalWise™                 | TinyPWM™         |
| Current Transfer Logic™  | IntelliMAX™                                     | SmartMax™                   | TinyWire™        |
| DEUXPEED®                | ISOPLANAR™                                      | SMART START™                | TranSiC™         |
| Dual Cool™               | Marking Small Speakers Sound Louder and Better™ | Solutions for Your Success™ | TriFault Detect™ |
| EcoSPARK®                | MegaBuck™                                       | SPM®                        | TRUECURRENT®*    |
| EfficientMax™            | MICROCOUPLER™                                   | STEALTH™                    | µSerDes™         |
| ESBC™                    | MicroFET™                                       | SuperFET®                   | UHC®             |
| <b>F</b> ®               | MicroPak™                                       | SuperSOT™-3                 | Ultra FRFET™     |
| Fairchild®               | MicroPak2™                                      | SuperSOT™-6                 | UniFET™          |
| Fairchild Semiconductor® | MillerDrive™                                    | SuperSOT™-8                 | VCX™             |
| FACT Quiet Series™       | MotionMax™                                      | SupreMOS®                   | VisualMax™       |
| FACT®                    | mWSaver®  | SyncFET™                    | VoltagePlus™     |
| FAST®                    | OptoHiT™  | Sync-Lock™                  | XS™              |
| FastvCore™               | OPTOLOGIC®                                      |                             | 仙童™              |
| FETBench™                | OPTOPLANAR®                                     |                             |                  |
| FPS™                     |   |                             |                  |

\*Trademarks of System General Corporation, used under license by Fairchild Semiconductor.

**DISCLAIMER**

FAIRCHILD SEMICONDUCTOR RESERVES THE RIGHT TO MAKE CHANGES WITHOUT FURTHER NOTICE TO ANY PRODUCTS HEREIN TO IMPROVE RELIABILITY, FUNCTION, OR DESIGN. FAIRCHILD DOES NOT ASSUME ANY LIABILITY ARISING OUT OF THE APPLICATION OR USE OF ANY PRODUCT OR CIRCUIT DESCRIBED HEREIN; NEITHER DOES IT CONVEY ANY LICENSE UNDER ITS PATENT RIGHTS, NOR THE RIGHTS OF OTHERS. THESE SPECIFICATIONS DO NOT EXPAND THE TERMS OF FAIRCHILD'S WORLDWIDE TERMS AND CONDITIONS, SPECIFICALLY THE WARRANTY THEREIN, WHICH COVERS THESE PRODUCTS.

**LIFE SUPPORT POLICY**

FAIRCHILD'S PRODUCTS ARE NOT AUTHORIZED FOR USE AS CRITICAL COMPONENTS IN LIFE SUPPORT DEVICES OR SYSTEMS WITHOUT THE EXPRESS WRITTEN APPROVAL OF FAIRCHILD SEMICONDUCTOR CORPORATION.

As used here in:

- Life support devices or systems are devices or systems which, (a) are intended for surgical implant into the body or (b) support or sustain life, and (c) whose failure to perform when properly used in accordance with instructions for use provided in the labeling, can be reasonably expected to result in a significant injury of the user.
- A critical component in any component of a life support, device, or system whose failure to perform can be reasonably expected to cause the failure of the life support device or system, or to affect its safety or effectiveness.

**ANTI-COUNTERFEITING POLICY**

Fairchild Semiconductor Corporation's Anti-Counterfeiting Policy. Fairchild's Anti-Counterfeiting Policy is also stated on our external website, [www.Fairchildsemi.com](http://www.Fairchildsemi.com), under Sales Support.

Counterfeiting of semiconductor parts is a growing problem in the industry. All manufactures of semiconductor products are experiencing counterfeiting of their parts. Customers who inadvertently purchase counterfeit parts experience many problems such as loss of brand reputation, substandard performance, failed application, and increased cost of production and manufacturing delays. Fairchild is taking strong measures to protect ourselves and our customers from the proliferation of counterfeit parts. Fairchild strongly encourages customers to purchase Fairchild parts either directly from Fairchild or from Authorized Fairchild Distributors who are listed by country on our web page cited above. Products customers buy either from Fairchild directly or from Authorized Fairchild Distributors are genuine parts, have full traceability, meet Fairchild's quality standards for handling and storage and provide access to Fairchild's full range of up-to-date technical and product information. Fairchild and our Authorized Distributors will stand behind all warranties and will appropriately address and warranty issues that may arise. Fairchild will not provide any warranty coverage or other assistance for parts bought from Unauthorized Sources. Fairchild is committed to combat this global problem and encourage our customers to do their part in stopping this practice by buying direct or from authorized distributors.

**PRODUCT STATUS DEFINITIONS**

**Definition of Terms**

| Datasheet Identification | Product Status        | Definition  |
|--------------------------|-----------------------|---|
| Advance Information      | Formative / In Design | Datasheet contains the design specifications for product development. Specifications may change in any manner without notice.   |
| Preliminary              | First Production      | Datasheet contains preliminary data; supplementary data will be published at a later date. Fairchild Semiconductor reserves the right to make changes at any time without notice to improve design. |
| No Identification Needed | Full Production       | Datasheet contains final specifications. Fairchild Semiconductor reserves the right to make changes at any time without notice to improve the design.   |
| Obsolete                 | Not In Production     | Datasheet contains specifications on a product that is discontinued by Fairchild Semiconductor. The datasheet is for reference information only.  |

Rev. 168