



FL73282 Half-Bridge Gate Driver

Features

- Floating Channel for Bootstrap Operation to +900 V
- Typically 350 mA / 650 mA Sourcing/Sinking Current Driving Capability for Both Channels
- Common-Mode dv/dt Noise Canceling Circuit
- Extended Allowable Negative V_S Swing to -9.8 V for Signal Propagation at $V_{CC}=V_{BS}=15$ V
- V_{CC} & V_{BS} Supply Range from 10 V to 20 V
- UVLO Functions for Both Channels
- Matched Propagation Delay Below 50 ns
- Built-in 170 ns Dead-Time
- Output in Phase with Input Signal

Description

The FL73282, a monolithic half bridge gate-drive IC, can drive MOSFETs and IGBTs that operate up to +900 V. Fairchild's high-voltage process and common mode noise canceling technique provides stable operation of the high-side driver under high-d V_S /dt noise circumstances. An advanced level-shift circuit allows high-side gate driver operation up to $V_S=-9.8$ V (typical) for $V_{BS}=15$ V. The UVLO circuits for both channels prevent malfunction when V_{CC} or V_{BS} is lower than the specified threshold voltage. Output drivers typically source/sink 350 mA / 650 mA, respectively, which is suitable for all kinds of half- and full-bridge inverters.



Figure 1. SOP 8

Applications

- Fluorescent Lamp Ballast
- HID Ballast
- SMPS
- Motor Driver
- General Purpose Half Bridge Topology

Ordering Information

Part Number	Operating Temperature Range	Package	Packing Method
FL73282MX ⁽¹⁾	-40°C to +125°C	8-Lead, Small Outline Integrated Circuit, (SOIC)	Tape & Reel

Note:

1. These devices passed wave-soldering test by JESD22A-111.

Typical Application Diagram

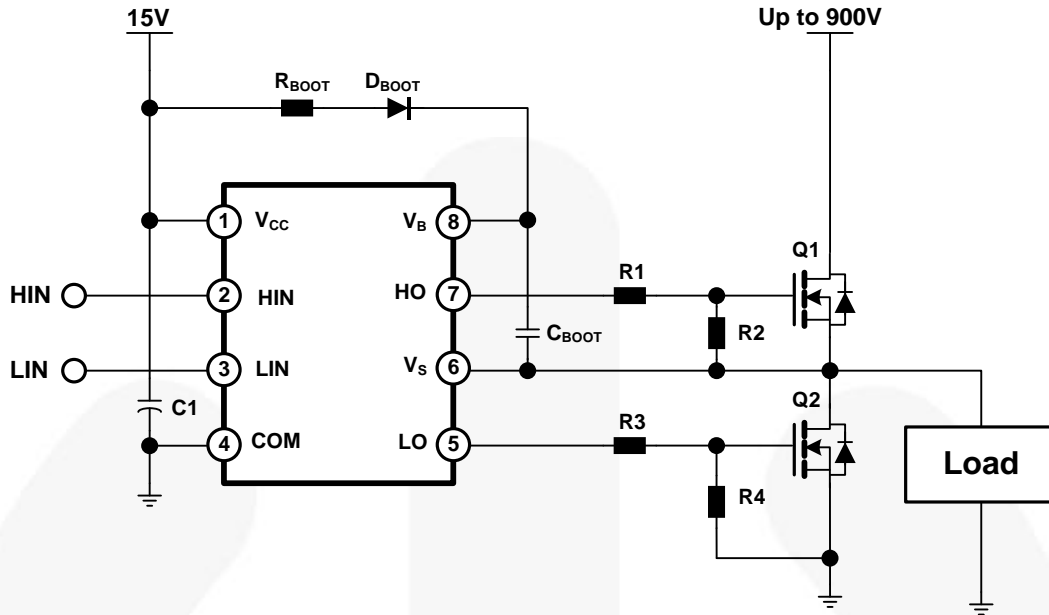

Figure 2. Application Circuit for Half Bridge Topology

Internal Block Diagram

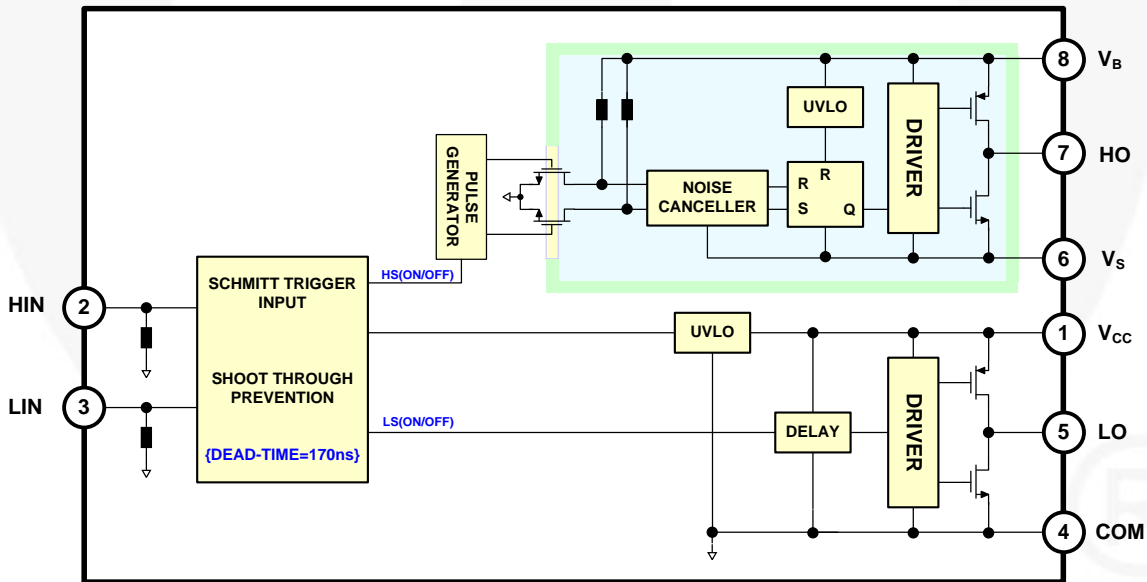

Figure 3. Functional Block Diagram

Pin Configuration

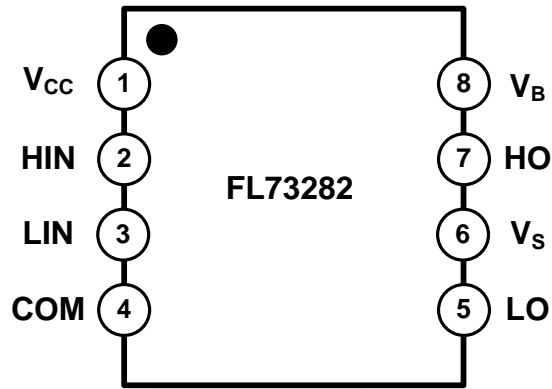

Figure 4. Pin Assignments (Top View)

Pin Definitions

Pin	Name	I/O	Description
1	V _{CC}	I	Low-Side Supply Voltage
2	HIN	I	Logic Input for High-Side Gate Driver Output
3	LIN	I	Logic Input for Low-Side Gate Driver Output
4	COM		Logic Ground and Low-Side Driver Return
5	LO	O	Low-Side Driver Output
6	V _S	I	High-Voltage Floating Supply Return
7	HO	O	High-Side Driver Output
8	V _B	I	High-Side Floating Supply

Absolute Maximum Ratings

Stresses exceeding the Absolute Maximum Ratings may damage the device. The device may not function or be operable above the recommended operating conditions and stressing the parts to these levels is not recommended. In addition, extended exposure to stresses above the recommended operating conditions may affect device reliability. The absolute maximum ratings are stress ratings only.

Symbol	Parameter	Min.	Max.	Unit
V_S	High-Side Floating Offset Voltage	V_B-24	$V_B+0.3$	V
V_B	High-Side Floating Supply Voltage	-0.3	924.0	V
V_{CC}	Low-Side and Logic-Fixed Supply Voltage	-0.3	24	V
V_{HO}	High-Side Floating Output Voltage V_{HO}	$V_S-0.3$	$V_B+0.3$	V
V_{LO}	Low-Side Floating Output Voltage V_{LO}	-0.3	$V_{CC}+0.3$	V
V_{IN}	Logic Input Voltage (HIN, LIN)	-0.3	$V_{CC}+0.3$	V
COM	Logic Ground	$V_{CC}-24$	$V_{CC}+0.3$	V
dV_S/dt	Allowable Offset Voltage Slew Rate		± 50	V/ns
$P_D^{(3)(4)(5)}$	Power Dissipation		0.625	W
θ_{JA}	Thermal Resistance		200	$^{\circ}\text{C}/\text{W}$
T_J	Junction Temperature		150	$^{\circ}\text{C}$
T_{STG}	Storage Temperature	-55	150	$^{\circ}\text{C}$

Notes:

- Mounted on 76.2 x 114.3 x 1.6 mm PCB (FR-4 glass epoxy material).
- Refer to the following standards:
JESD51-2: Integral circuit's thermal test method environmental conditions, natural convection;
JESD51-3: Low effective thermal conductivity test board for leaded surface-mount packages.
- Do not exceed maximum power dissipation (P_D) under any circumstances.

Recommended Operating Conditions

The Recommended Operating Conditions table defines the conditions for actual device operation. Recommended operating conditions are specified to ensure optimal performance to the datasheet specifications. Fairchild does not recommend exceeding them or designing to Absolute Maximum Ratings.

Symbol	Parameter	Min.	Max.	Unit
V_B	High-Side Floating Supply Voltage	V_S+10	V_S+20	V
V_S	High-Side Floating Supply Offset Voltage	$6-V_{CC}$	900	V
V_{HO}	High-Side (HO) Output Voltage	V_S	V_B	V
V_{LO}	Low-Side (LO) Output Voltage	COM	V_{CC}	V
V_{IN}	Logic Input Voltage (HIN, LIN)	COM	V_{CC}	V
V_{CC}	Low-Side Supply Voltage	10	20	V
T_A	Ambient Temperature	-40	+125	$^{\circ}\text{C}$

Static Electrical Characteristics

$V_{BIAS}(V_{CC}, V_{BS}) = 15.0\text{ V}$, $T_A = 25^\circ\text{C}$, unless otherwise specified. The V_{IN} and I_{IN} parameters are referenced to COM. The V_O and I_O parameters are referenced to V_S and COM and are applicable to the respective outputs HO and LO.

Symbol	Parameter	Condition	Min.	Typ.	Max.	Unit
Power Supply Section						
I_{QCC}	Quiescent V_{CC} Supply Current	$V_{IN}=0\text{ V or }5\text{ V}$		80	180	μA
I_{QBS}	Quiescent V_{BS} Supply Current	$V_{IN}=0\text{ V or }5\text{ V}$		50	120	μA
I_{PCC}	Operating V_{CC} Supply Current	$f_{IN}=20\text{ kHz, rms value}$			550	μA
I_{PBS}	Operating V_{BS} Supply Current	$f_{IN}=20\text{ kHz, rms value}$			600	μA
I_{LK}	Offset Supply Leakage Current	$V_B=V_S=900\text{ V}$			10	μA
Bootstrapped Supply Section						
V_{CCUV+} V_{BSUV+}	V_{CC} & V_{BS} Supply Under-Voltage Positive going Threshold		8.2	9.2	10.0	V
V_{CCUV-} V_{BSUV-}	V_{CC} & V_{BS} Supply Under-Voltage Negative going Threshold		7.6	8.7	9.6	V
V_{CCUVH} V_{BSUVH}	V_{CC} Supply Under-Voltage Lockout Hysteresis			0.5		V
Input Section						
V_{IH}	Logic "1" Input Voltage		2.5			V
V_{IL}	Logic "0" Input Voltage				0.8	V
I_{IN+}	Logic "1" Input Bias Current	$V_{IN}=5\text{ V}$		20	50	μA
I_{IN-}	Logic "0" Input Bias Current	$V_{IN}=0\text{ V}$		1.0	2.0	μA
R_{IN}	Logic Input Pull-Down Resistance		100	250		$\text{K}\Omega$
Gate Driver Output Section						
V_{OH}	High-Level Output Voltage, $V_{BIAS}-V_O$	$I_O=0\text{ A}$			85	mV
V_{OL}	Low-Level Output Voltage, V_O	$I_O=0\text{ A}$			85	mV
I_{O+}	Output HIGH Short-Circuit Pulsed Current	$V_O=0\text{ V}, V_{IN}=5\text{ V}$ with $PW \leq 10\ \mu\text{s}$	250	350		mA
I_{O-}	Output LOW Short-Circuit Pulsed Current	$V_O=15\text{ V}, V_{IN}=0\text{ V}$ with $PW \leq 10\ \mu\text{s}$	500	650		mA
V_S	Allowable Negative V_S Pin Voltage for HIN Signal Propagation to HO			-9.8	-7.0	V

Dynamic Electrical Characteristics

$V_{BIAS}(V_{CC}, V_{BS}) = 15.0\text{ V}$, $V_S = \text{COM}$, $C_L = 1000\text{ pF}$ and $T_A = 25^\circ\text{C}$, unless otherwise specified..

Symbol	Parameter	Conditions	Min.	Typ.	Max.	Unit
t_{ON}	Turn-On Propagation Delay	$V_S=0\text{ V}$	80	150	220	ns
t_{OFF}	Turn-Off Propagation Delay	$V_S=0\text{ V}$ or $900\text{ V}^{(5)}$	80	150	220	ns
t_R	Turn-On Rise Time	$V_{LIN}=V_{HIN}=5\text{ V}$		60	140	ns
t_F	Turn-Off Fall Time	$V_{LIN}=V_{HIN}=0\text{ V}$		30	80	ns
DT	Dead Time		70	170	270	ns
MT	Delay Matching, HS & LS Turn-on/off				50	ns
t_{PW}	Minimum Input Pulse Width that changes the Output ⁽⁵⁾⁽⁶⁾				220	ns

Notes:

5. These parameters are guaranteed by design.
6. The minimum input pulse width time included dead time

Typical Characteristics

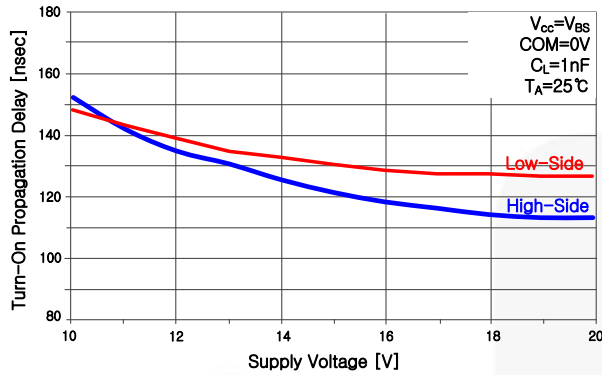

Figure 5. Turn-On Propagation Delay vs. Supply Voltage

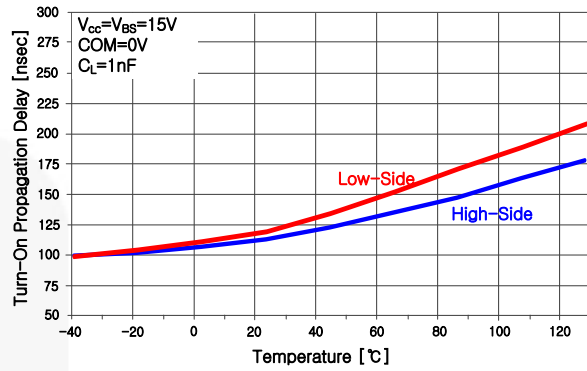

Figure 6. Turn-On Propagation Delay vs. Temperature

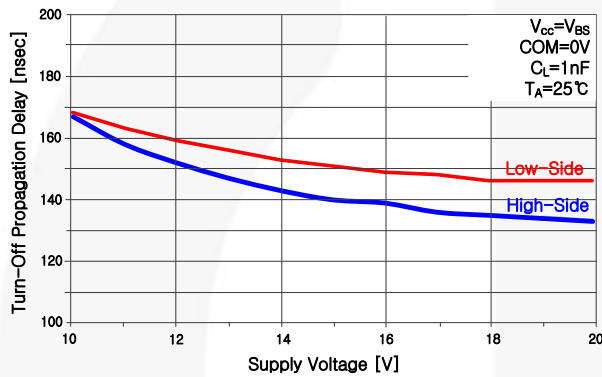

Figure 7. Turn-Off Propagation Delay vs. Supply Voltage

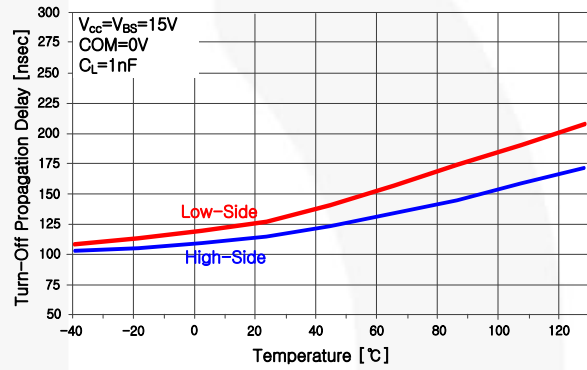

Figure 8. Turn-Off Propagation Delay vs. Temperature

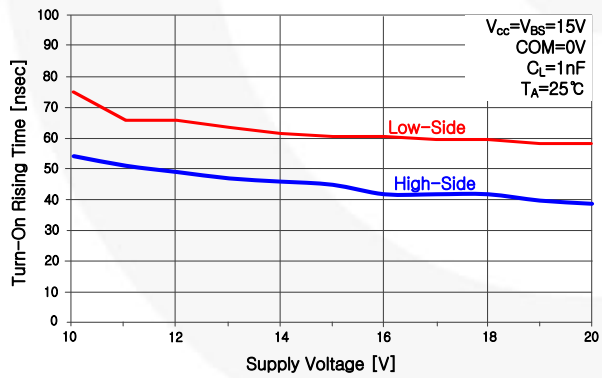

Figure 9. Turn-On Rising Time vs. Supply Voltage

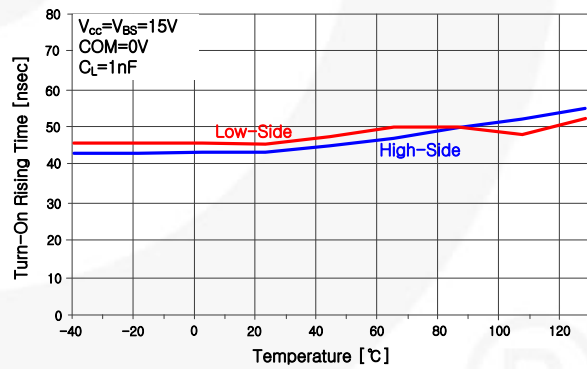

Figure 10. Turn-On Rising Time vs. Temperature

Typical Characteristics (Continued)

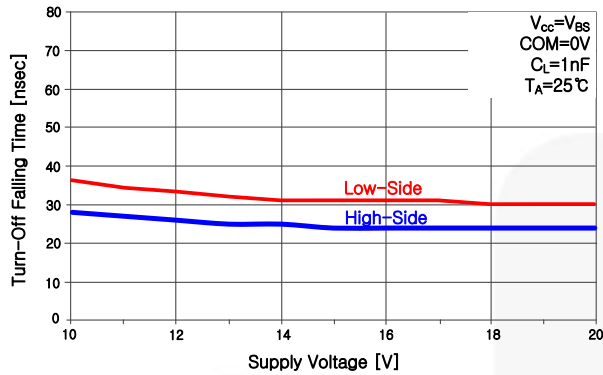

Figure 11. Turn-Off Falling Time vs. Supply Voltage

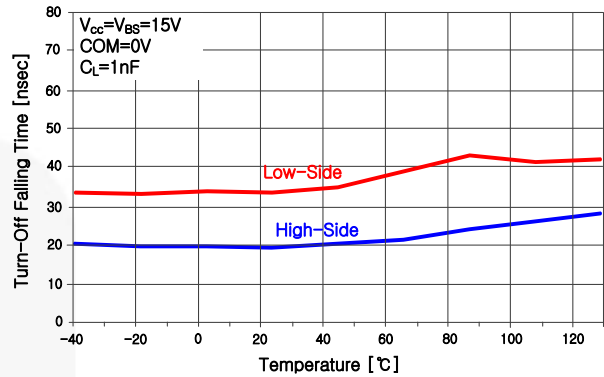

Figure 12. Turn-Off Falling vs. Temperature

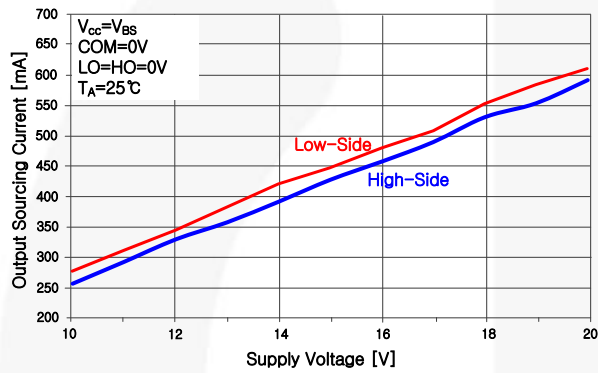

Figure 13. Output Sourcing Current vs. Supply Voltage

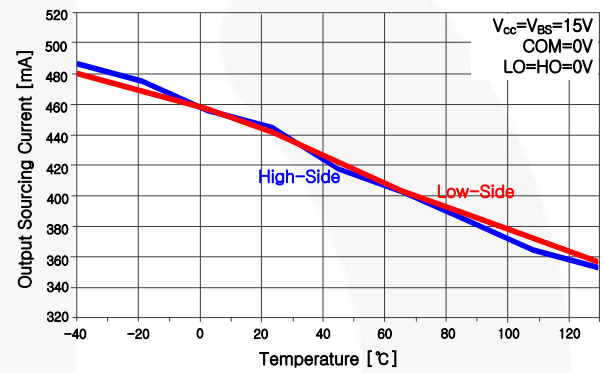

Figure 14. Output Sourcing Current vs. Temperature

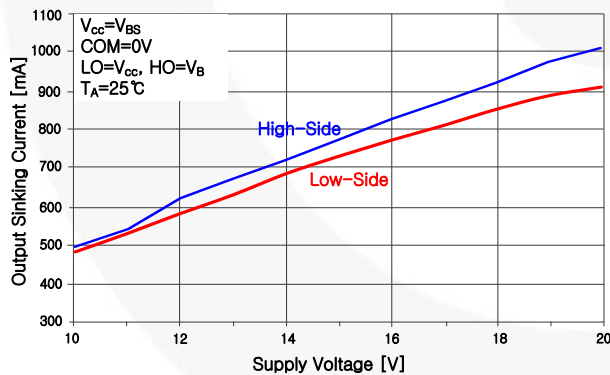

Figure 15. Output Sinking Current vs. Supply Voltage

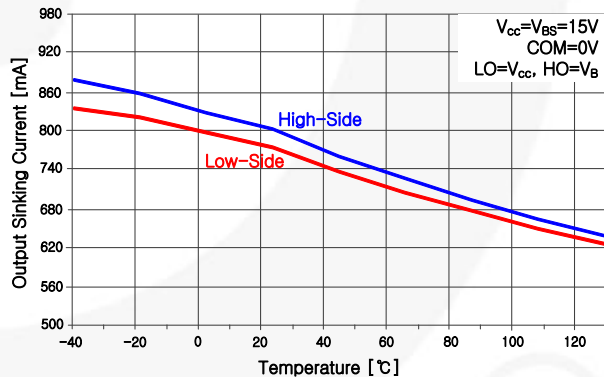

Figure 16. Output Sinking Current vs. Temperature

Typical Characteristics (Continued)

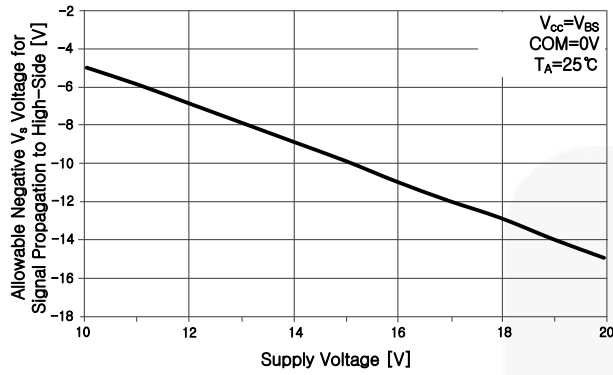

Figure 17. Allowable Negative V_s Voltage for Signal Propagation to High Side vs. Supply Voltage

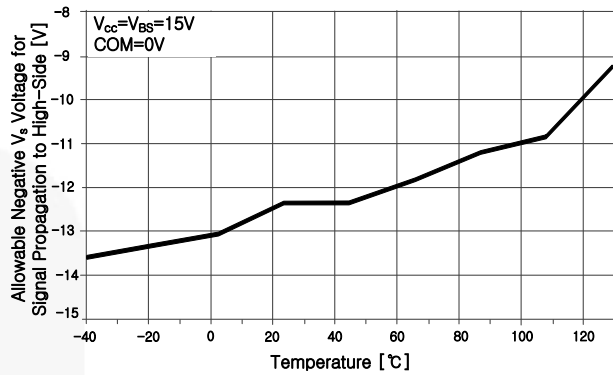

Figure 18. Allowable Negative V_s Voltage for Signal Propagation to High Side vs. Temperature

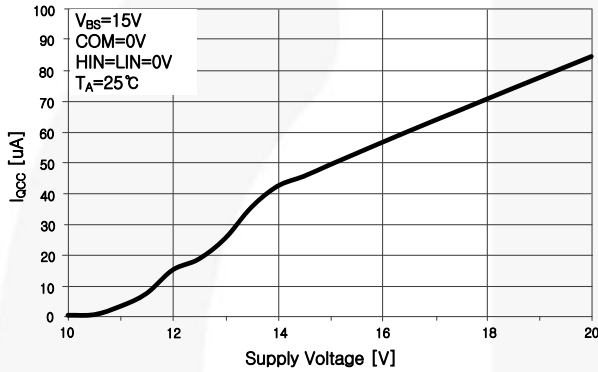

Figure 19. I_{QCC} vs. Supply Voltage

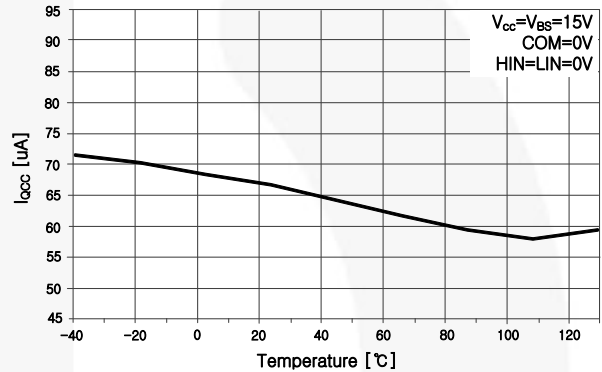

Figure 20. I_{QCC} vs. Temperature

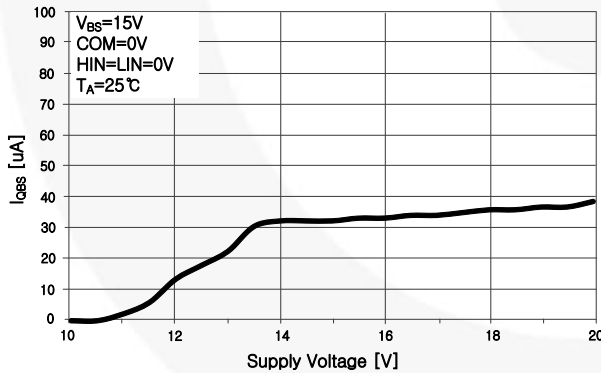

Figure 21. I_{QBS} vs. Supply Voltage

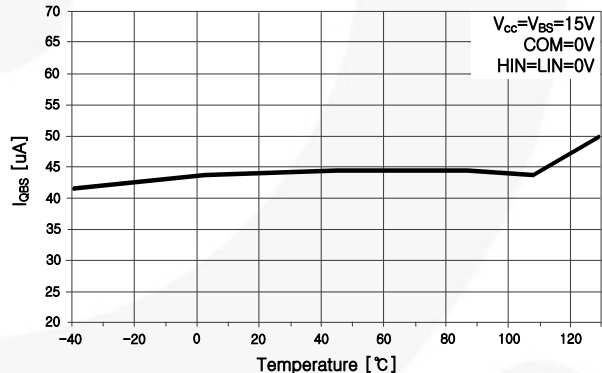

Figure 22. I_{QBS} vs. Temperature

Typical Characteristics (Continued)

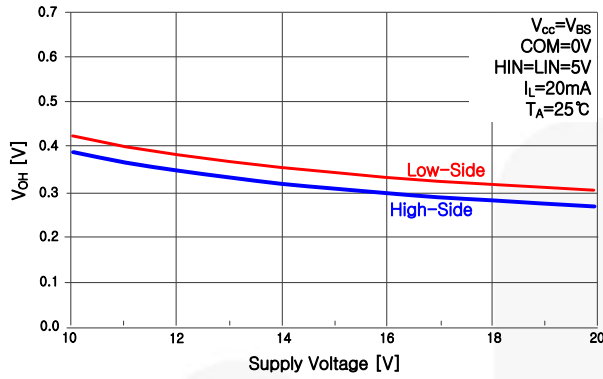

Figure 23. High-Level Output Voltage vs. Supply Voltage

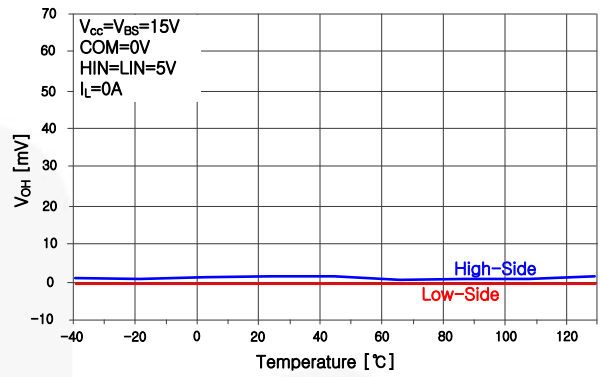

Figure 24. High-Level Output Voltage vs. Temperature

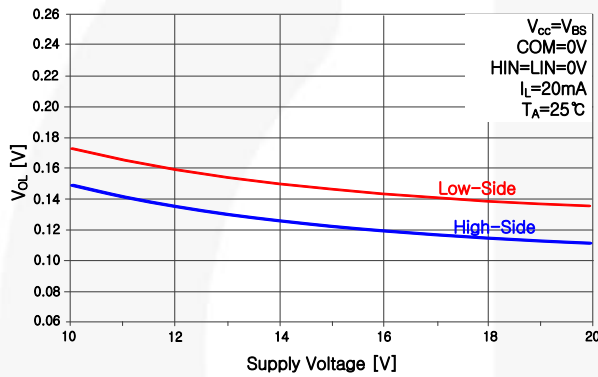

Figure 25. Low-Level Output Voltage vs. Supply Voltage

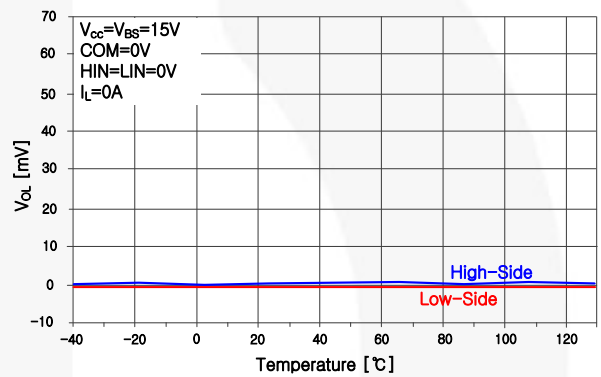

Figure 26. Low-Level Output Voltage vs. Temperature

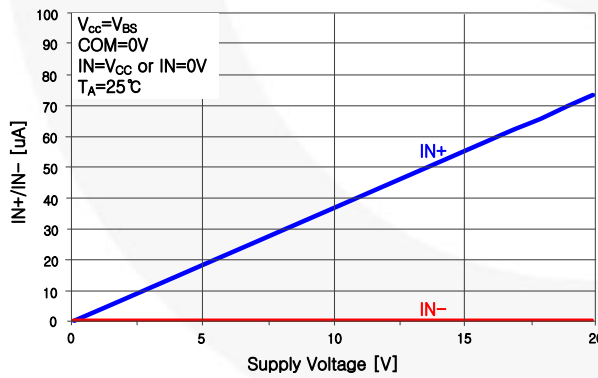

Figure 27. Input Bias Current vs. Supply Voltage

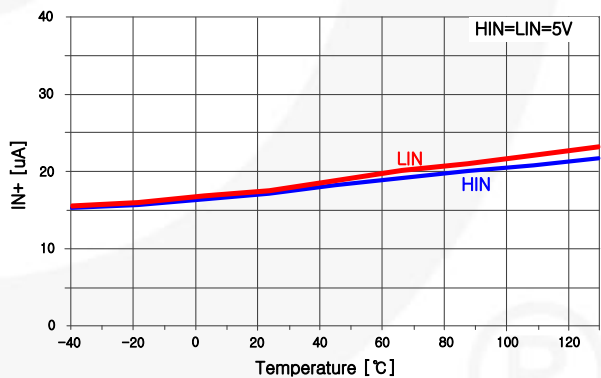

Figure 28. Input Bias Current vs. Temperature

Typical Characteristics (Continued)

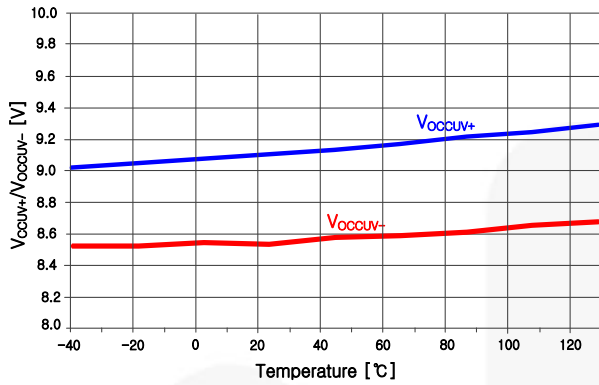

Figure 29. V_{CC} UVLO Threshold Voltage vs. Temperature

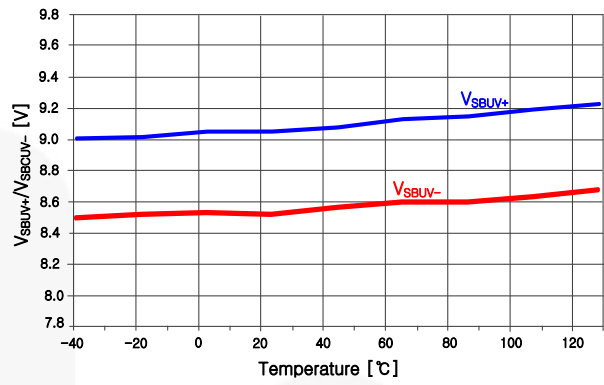

Figure 30. V_{BS} UVLO Threshold Voltage vs. Temperature

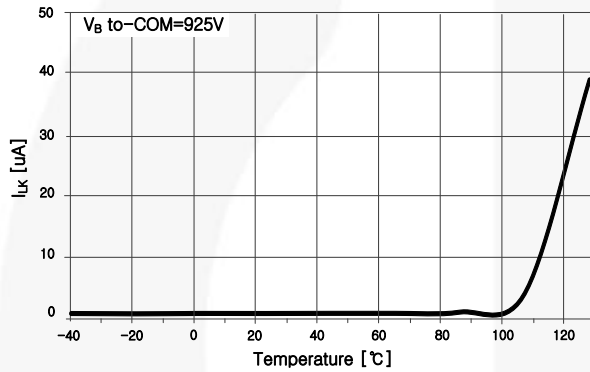

Figure 31. V_B to COM Leakage Current vs. Temperature

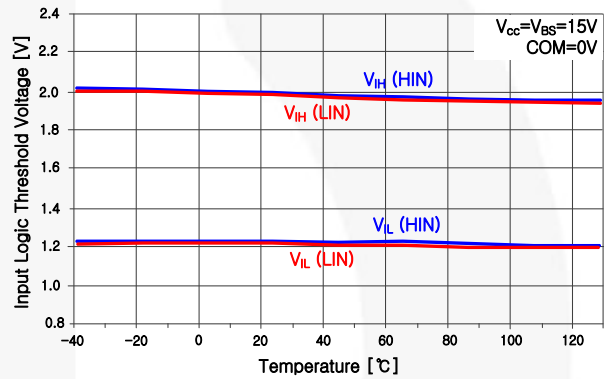

Figure 32. Input Logic Threshold Voltage vs. Temperature

Switching Time Definitions (Continued)

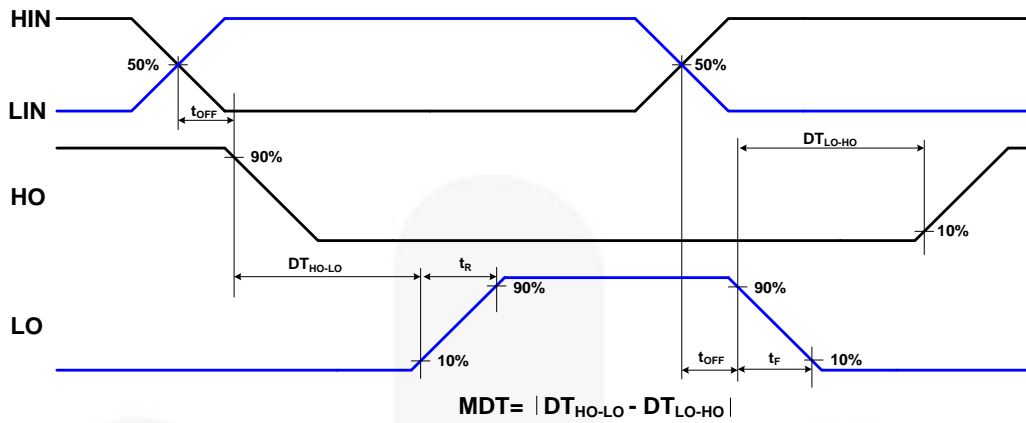

Figure 36. Internal Dead Time Definition



NOTES:

- A) THIS PACKAGE CONFORMS TO JEDEC MS-012, VARIATION AA.
- B) ALL DIMENSIONS ARE IN MILLIMETERS.
- C) DIMENSIONS DO NOT INCLUDE MOLD FLASH OR BURRS.
- D) LANDPATTERN STANDARD: SOIC127P600X175-8M
- E) DRAWING FILENAME: M08Arev16





TRADEMARKS

The following includes registered and unregistered trademarks and service marks, owned by Fairchild Semiconductor and/or its global subsidiaries, and is not intended to be an exhaustive list of all such trademarks.

- | | | | |
|--------------------------|--|---------------------------------------|------------------|
| AccuPower™ | F-PFS™ | OPTOPLANAR® | SYSTEM GENERAL® |
| AttitudeEngine™ | FRFET® | Power Supply WebDesigner™ | TinyBoost® |
| Awinda® | Global Power Resource SM | PowerTrench® | TinyBuck® |
| AX-CAP®* | GreenBridge™ | PowerXS™ | TinyCalc™ |
| BitSiC™ | Green FPS™ | Programmable Active Droop™ | TinyLogic® |
| Build it Now™ | Green FPS™ e-Series™ | QFET® | TINYOPTO™ |
| CorePLUS™ | Gmax™ | QS™ | TinyPower™ |
| CorePOWER™ | GTO™ | Quiet Series™ | TinyPWM™ |
| CROSSVOL™ | IntelliMAX™ | RapidConfigure™ | TinyWire™ |
| CTL™ | ISOPLANAR™ | Saving our world, 1mW/W/kW at a time™ | TranSiC™ |
| Current Transfer Logic™ | Making Small Speakers Sound Louder and Better™ | SignalWise™ | TriFault Detect™ |
| DEUXPEED® | MegaBuck™ | SmartMax™ | TRUECURRENT®* |
| Dual Cool™ | MICROCOUPLER™ | SMART START™ | μSerDes™ |
| EcoSPARK® | MicroFET™ | Solutions for Your Success™ | UHC® |
| EfficientMax™ | MicroPak™ | SPM® | Ultra FRFET™ |
| ESBC™ | MicroPak2™ | STEALTH™ | UniFET™ |
| F [®] | MillerDrive™ | SuperFET® | Vcx™ |
| Fairchild® | MotionMax™ | SuperSOT™-3 | VisualMax™ |
| Fairchild Semiconductor® | MotionGrid® | SuperSOT™-6 | VoltagePlus™ |
| FACT Quiet Series™ | MTi® | SuperSOT™-8 | Xs™ |
| FACT® | MTx® | SupreMOS® | Xsens™ |
| FastvCore™ | MVN® | SyncFET™ | 仙童® |
| FETBench™ | mWSaver® | Sync-Lock™ | |
| FPS™ | OptoHiT™ | | |
| | OPTOLOGIC® | | |

* Trademarks of System General Corporation, used under license by Fairchild Semiconductor.

DISCLAIMER

FAIRCHILD SEMICONDUCTOR RESERVES THE RIGHT TO MAKE CHANGES WITHOUT FURTHER NOTICE TO ANY PRODUCTS HEREIN TO IMPROVE RELIABILITY, FUNCTION, OR DESIGN. TO OBTAIN THE LATEST, MOST UP-TO-DATE DATASHEET AND PRODUCT INFORMATION, VISIT OUR WEBSITE AT [HTTP://WWW.FAIRCHILDSEMI.COM](http://www.fairchildsemi.com). FAIRCHILD DOES NOT ASSUME ANY LIABILITY ARISING OUT OF THE APPLICATION OR USE OF ANY PRODUCT OR CIRCUIT DESCRIBED HEREIN; NEITHER DOES IT CONVEY ANY LICENSE UNDER ITS PATENT RIGHTS, NOR THE RIGHTS OF OTHERS. THESE SPECIFICATIONS DO NOT EXPAND THE TERMS OF FAIRCHILD'S WORLDWIDE TERMS AND CONDITIONS, SPECIFICALLY THE WARRANTY THEREIN, WHICH COVERS THESE PRODUCTS.

AUTHORIZED USE

Unless otherwise specified in this data sheet, this product is a standard commercial product and is not intended for use in applications that require extraordinary levels of quality and reliability. This product may not be used in the following applications, unless specifically approved in writing by a Fairchild officer: (1) automotive or other transportation, (2) military/aerospace, (3) any safety critical application – including life critical medical equipment – where the failure of the Fairchild product reasonably would be expected to result in personal injury, death or property damage. Customer's use of this product is subject to agreement of this Authorized Use policy. In the event of an unauthorized use of Fairchild's product, Fairchild accepts no liability in the event of product failure. In other respects, this product shall be subject to Fairchild's Worldwide Terms and Conditions of Sale, unless a separate agreement has been signed by both Parties.

ANTI-COUNTERFEITING POLICY

Fairchild Semiconductor Corporation's Anti-Counterfeiting Policy. Fairchild's Anti-Counterfeiting Policy is also stated on our external website, www.fairchildsemi.com, under Terms of Use

Counterfeiting of semiconductor parts is a growing problem in the industry. All manufacturers of semiconductor products are experiencing counterfeiting of their parts. Customers who inadvertently purchase counterfeit parts experience many problems such as loss of brand reputation, substandard performance, failed applications, and increased cost of production and manufacturing delays. Fairchild is taking strong measures to protect ourselves and our customers from the proliferation of counterfeit parts. Fairchild strongly encourages customers to purchase Fairchild parts either directly from Fairchild or from Authorized Fairchild Distributors who are listed by country on our web page cited above. Products customers buy either from Fairchild directly or from Authorized Fairchild Distributors are genuine parts, have full traceability, meet Fairchild's quality standards for handling and storage and provide access to Fairchild's full range of up-to-date technical and product information. Fairchild and our Authorized Distributors will stand behind all warranties and will appropriately address any warranty issues that may arise. Fairchild will not provide any warranty coverage or other assistance for parts bought from Unauthorized Sources. Fairchild is committed to combat this global problem and encourage our customers to do their part in stopping this practice by buying direct or from authorized distributors.

PRODUCT STATUS DEFINITIONS

Definition of Terms

Datasheet Identification	Product Status	Definition
Advance Information	Formative / In Design	Datasheet contains the design specifications for product development. Specifications may change in any manner without notice.
Preliminary	First Production	Datasheet contains preliminary data; supplementary data will be published at a later date. Fairchild Semiconductor reserves the right to make changes at any time without notice to improve design.
No Identification Needed	Full Production	Datasheet contains final specifications. Fairchild Semiconductor reserves the right to make changes at any time without notice to improve the design.
Obsolete	Not In Production	Datasheet contains specifications on a product that is discontinued by Fairchild Semiconductor. The datasheet is for reference information only.

Rev. I77